

 **TRACO POWER**

2019 | **Medical Power Solutions**
Product Portfolio

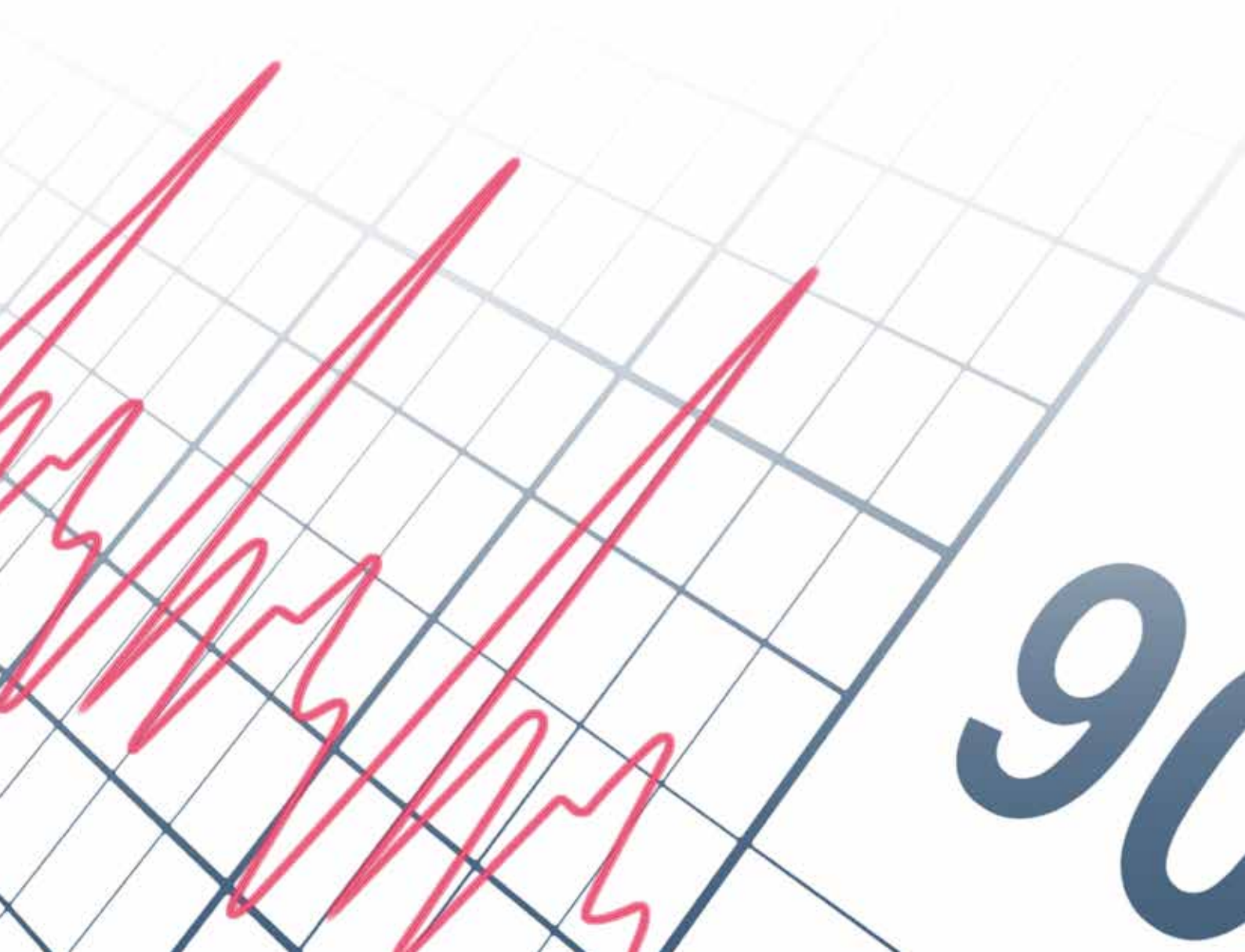

Company Profile

TRACO Electronic AG is a Swiss company with headquarters based in Baar, Switzerland. As a leading power supply specialist with more than 35 years experience we are dedicated to the design and manufacturing of high quality DC/DC and AC/DC power conversion products.

TRACO markets its products worldwide under the registered trademark TRACO POWER. Our mission is to provide our customers with optimal power supply solutions in terms of performance, quality and cost for their individual application.

TRACO POWER products for applied versus non-applied medical requirements

For non-applied parts sections of medical equipment, power and safety requirements can be satisfied by any of Traco Power power supplies, non-medical for 1×MOOP applications and medical rated power supplies for all other MOPP levels. If this part of the system is attaching to a DC input from a non-medical rated power supply, then use of our DC/DC Converters should satisfy safety requirements for 1×MOPP / 2×MOPP applications.

For applied parts sections of medical equipment, the clearance and creepage distances, as well as a secondary isolation barrier are required to further isolate the patient from potentially high voltages (2×MOPP is means of patient protection). The isolation barrier may be satisfied using Traco Power medical rated 2×MOPP AC/DC power supplies or DC/DC converters.

Even this reinforced insulation system does not unconditionally qualify a power supply unit and DC/DC converter for medical applications. Particular and collateral standards also require that a risk/quality management System be in place at the component level, especially for safety critical applications.

TRACO POWER products for applied parts applications with a 2×MOPP rating, have been carefully designed and manufactured to the highest standards to meet the increased quality, reliability and safety standards for medical equipment. These products have fully regulated output voltages and feature:

- Product certification according to IEC/EN/ES 60601-1 3rd edition for 2×MOPP
- Risk management process according to ISO 14971 including risk management file
- EMC emission and immunity to IEC 60601-1-2 edition 4
- Acceptance criteria for electronic assemblies according to IPC-A-610 Level 3
- Design and production to ISO 13485 quality management system
- 5-year product warranty

DC/DC Converters

NEW	TIM 2(SM) Series	2 Watt in DIP-16 or SMD package	4
NEW	TIM 3.5(SM) Series	3.5 Watt in DIP-16 or SMD package	4
	THM 3(WI) Series	3 Watt in DIP-24 package	4
	THM 6(WI) Series	6 Watt in DIP-24 package	5
	THM 10(WI) Series	10 Watt in DIP-24 package	5
	THM 15(WI) Series	15 Watt in 1.6" x 1" package	5
	THM 20(WI) Series	20 Watt in 1.6" x 1" package	6
	THM 30(WI) Series	30 Watt in 2" x 1" package	6

AC/DC Power Supplies

	TMF 05 Series	5 Watt encapsulated power module	7
	TMF 10 Series	10 Watt encapsulated power module	7
NEW	TPP 15 Series	15 Watt open frame/encapsulated power module	7-8
	TMF 20 Series	20 Watt encapsulated power module	9
	TMF 30 Series	30 Watt encapsulated power module	9
NEW	TPP 30 Series	30 Watt open frame/encapsulated power module	9-10
	TPP 40 Series	40 Watt open frame/encased power supply	11
	TPP 65 Series	65 Watt open frame/encased power supply	11-12
	TPP 100 Series	100 Watt open frame/encased power supply	12
	TPP 150 Series	150 Watt open frame/encased power supply	13
NEW	TPP 180 Series	180 Watt open frame power supply	13
NEW	TPP 300 Series	300 Watt open frame power supply	14
NEW	TPP 450 Series	450 Watt open frame/encased power supply	14

TIM 2(SM) Series

NEW

2 Watt DC/DC converter in DIP or SMD package

- 3:1 input voltage with extended low input range:
4.5-12, 9-18, 18-36, 36-75
- Output voltages:
3.3, 5.0, 12, 15, 24, ±12, ±15 VDC
- I/O isolation 5000 VACrms rated for 250 VACrms working voltage
- Low leakage current <2 µA
- Input filter to meet EN 55032 class A



www.tracopower.com/overview/tim2 www.tracopower.com/overview/tim2sm

- 1: -Vin
- 2: On/Off
- 7: NC
- 8: NC / com
- 9: +Vout
- 10: -Vout
- 16: +Vin

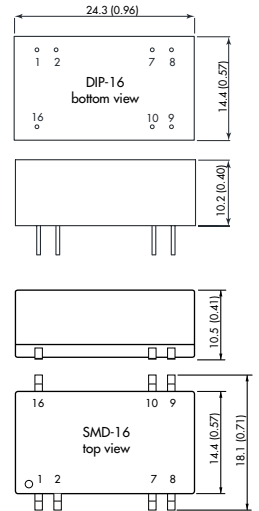

TIM 3.5(SM) Series

NEW

3.5 Watt DC/DC converter in DIP-16 package

- 2:1 input voltage with extended low input range:
4.5-12, 9-18, 18-36, 36-75
- Output voltages:
5.0, 12, 15, 24, ±12, ±15 VDC
- I/O isolation 5000 VACrms rated for 250 VACrms working voltage
- Low leakage current <2 µA
- Input filter to meet EN 55032 class A

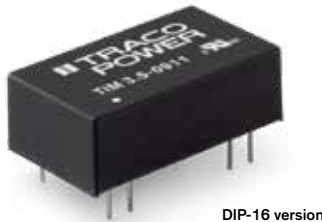

www.tracopower.com/overview/tim3 www.tracopower.com/overview/tim3sm

- 1: -Vin
- 2: On/Off
- 7: NC
- 8: NC / com
- 9: +Vout
- 10: -Vout
- 16: +Vin

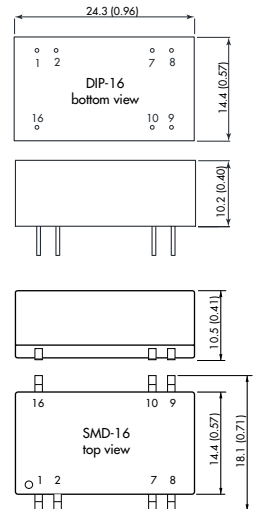

THM 3(WI) Series

3 Watt DC/DC converter in DIP-24 package

- THM 3: 2:1 input voltage ranges
4.5-9, 9-18, 18-36, 36-75
THM 3WI: 4:1 input voltage ranges
4.5-9, 9-36, 18-75 VDC
- Output voltages:
3.3, 5.0, 12, 15, 24, ±5, ±12, ±15 VDC
- I/O isolation 5000 VACrms rated for 250 VACrms working voltage
- Low leakage current <2 µA
- Very high efficiency up to 87%
- Extended operating temperature range
-40°C to 80°C at full load.
- Input filter to meet EN 55032 class A



www.tracopower.com/overview/thm3 www.tracopower.com/overview/thm3wi

- | | |
|---------------|---------------|
| 2:1 Input | 4:1 Input |
| Single output | Single output |
| 1: +Vin | 2: -Vin |
| 11: no pin | 11: NC |
| 12: -Vout | 14: +Vout |
| 13: +Vout | 16: -Vout |
| 15: no pin | 22: +Vin |
| 23: -Vin | 23: +Vin |
| 24: -Vin | |
| Dual output | Dual output |
| 1: +Vin | 2: -Vin |
| 11: com | 11: -Vout |
| 12: no pin | 14: +Vout |
| 13: -Vout | 16: com |
| 15: +Vout | 22: +Vin |
| 23: -Vin | 23: +Vin |
| 24: -Vin | |

Optional: interchanged pinning

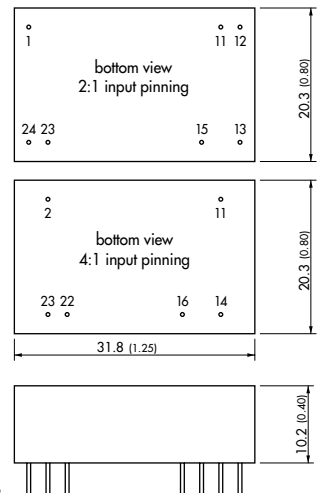

THM 6(WI) Series

6 Watt DC/DC converter in DIP-24 package

- THM 6: 2:1 input voltage ranges
4.5-9, 9-18, 18-36, 36-75
THM 6WI: 4:1 input voltage ranges
4.5-9, 9-36, 18-75 VDC
- Output voltages:
3.3, 5.0, 12, 15, 24, ± 5 , ± 12 , ± 15 VDC
- I/O isolation 5000 VACrms rated for
250 VACrms working voltage
- Low leakage current $< 2 \mu\text{A}$
- Very high efficiency up to 88%
- Extended operating temperature range
 -40°C to 70°C at full load.
- Input filter to meet EN 55032 class A



www.tracopower.com/overview/thm6 www.tracopower.com/overview/thm6wi

2:1 Input	4:1 Input
Single output	Single output
1: +Vin	2: -Vin
11: no pin	11: NC
12: -Vout	14: +Vout
13: +Vout	16: -Vout
15: no pin	22: +Vin
23: -Vin	23: +Vin
24: -Vin	
Dual output	Dual output
1: +Vin	11: -Vout
11: com	14: +Vout
12: no pin	16: com
13: -Vout	22: +Vin
15: +Vout	23: +Vin
23: -Vin	
24: -Vin	

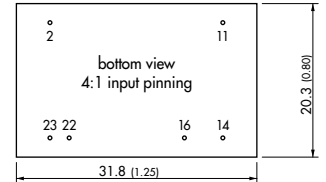
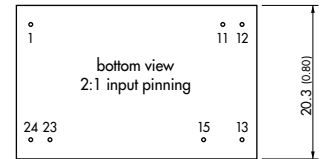

Optional: interchanged pinning

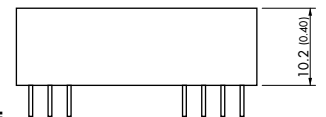

THM 10(WI) Series

10 Watt DC/DC converter in DIP-24 package

- THM 10: 2:1 input voltage ranges
4.5-9, 9-18, 18-36, 36-75
THM 10WI: 4:1 input voltage ranges
4.5-9, 9-36, 18-75 VDC
- Output voltages:
3.3, 5.0, 12, 15, 24, ± 5 , ± 12 , ± 15 VDC
- I/O isolation 5000 VACrms rated for
250 VACrms working voltage
- Low leakage current $< 2 \mu\text{A}$
- Very high efficiency up to 89%
- Input filter to meet EN 55032 class A



www.tracopower.com/overview/thm10 www.tracopower.com/overview/thm10wi

2:1 Input	4:1 Input
Single output	Single output
1: +Vin	2: -Vin
11: no pin	11: NC
12: -Vout	14: +Vout
13: +Vout	16: -Vout
15: no pin	22: +Vin
23: -Vin	23: +Vin
24: -Vin	
Dual output	Dual output
1: +Vin	11: -Vout
11: com	14: +Vout
12: no pin	16: com
13: -Vout	22: +Vin
15: +Vout	23: +Vin
23: -Vin	
24: -Vin	

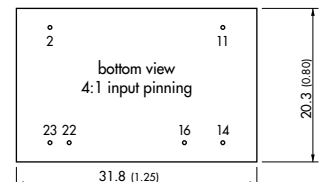
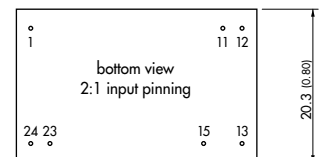

Optional: interchanged pinning

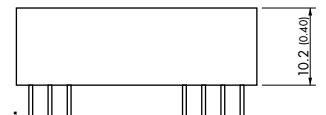

THM 15(WI) Series

15 Watt DC/DC converter in 1.6" x 1" package

- THM 15: 2:1 input voltage ranges:
9-18, 18-36, 36-75
THM 15WI: 4:1 input voltage ranges:
9-36, 18-75
- Output voltages:
5.0, 12, 15, 24 VDC adjust. $\pm 10\%$
 ± 5 , ± 12 , ± 15 VDC
- I/O isolation 5000 VACrms rated for
250 VACrms working voltage
- Low leakage current
- Very high efficiency up to 90%



www.tracopower.com/overview/thm15 www.tracopower.com/overview/thm15wi

Single output
1: +Vin
2: -Vin
3: +Vout
4: -Vout
5: Trim
Dual output
1: +Vin
2: -Vin
3: +Vout
4: com.
5: -Vout

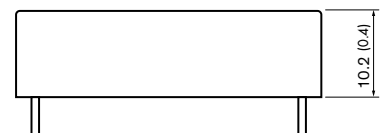
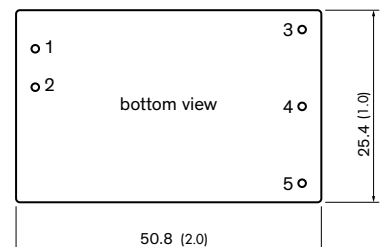

THM 20(WI) Series

20 Watt DC/DC converter in 1.6" x 1" package

- THM 20: 2:1 input voltage ranges:
9-18, 18-36, 36-75
THM 20WI: 4:1 input voltage ranges:
9-36, 18-75
- Output voltages:
5.0, 12, 15, 24 VDC adjust. $\pm 10\%$
 $\pm 5, \pm 12, \pm 15$ VDC
- I/O isolation 5000 VACrms rated for
250 VACrms working voltage
- Low leakage current
- Very high efficiency up to 90%



Single output
1: +Vin
2: -Vin
3: +Vout
4: -Vout
5: Trim

Dual output
1: +Vin
2: -Vin
3: +Vout
4: com.
5: -Vout

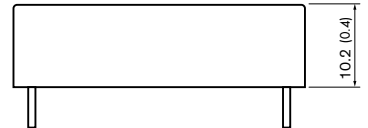
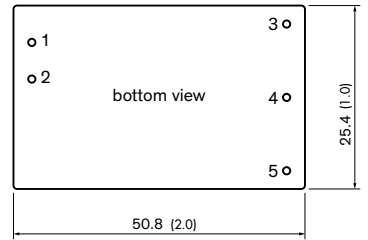

www.tracopower.com/overview/thm20 www.tracopower.com/overview/thm20wi

THM 30(WI) Series

30 Watt DC/DC converter in 2" x 1" package

- THM 30: 2:1 input voltage ranges:
9-18, 18-36, 36-75
THM 30WI: 4:1 input voltage ranges:
9-36, 18-75
- Output voltages:
5.0, 12, 15, 24 VDC adjust. $\pm 10\%$
 $\pm 5, \pm 12, \pm 15$ VDC
- I/O isolation 5000 VACrms rated for
250 VACrms working voltage
- Low leakage current
- Very high efficiency up to 90%



Single output
1: +Vin
2: -Vin
3: +Vout
4: -Vout
5: Trim

Dual output
1: +Vin
2: -Vin
3: +Vout
4: com.
5: -Vout

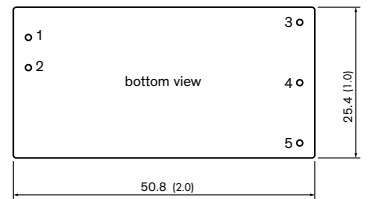

www.tracopower.com/overview/thm30 www.tracopower.com/overview/thm30wi

TMF 05 Series

- Universal input 90-264 VAC and 120-370 VDC
- Output voltages: 5.0, 12, 15, 24 VDC
- Fully encapsulated ultra compact plastic casing for PCB mount
- Protection class II prepared
- Low leakage current <math>< 100 \mu\text{A}</math>
- Operating temperature range -25°C to 70°C .
- Input filter to meet EN 55032 class B



www.tracopower.com/overview/tmf05

5 Watt AC/DC power module

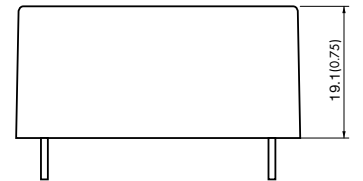
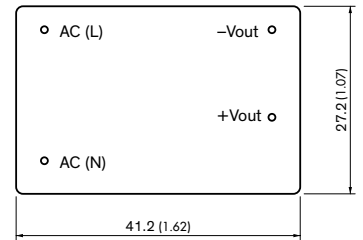

TMF 10 Series

- Universal input 90-264 VAC and 120-370 VDC
- Output voltages: 5.0, 12, 15, 24 VDC
- Fully encapsulated ultra compact plastic casing for PCB mount
- Protection class II prepared
- Low leakage current <math>< 100 \mu\text{A}</math>
- Operating temperature range -25°C to 70°C .
- Input filter to meet EN 55032 class B



www.tracopower.com/overview/tmf10

10 Watt AC/DC power module

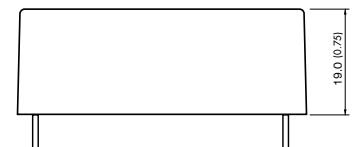
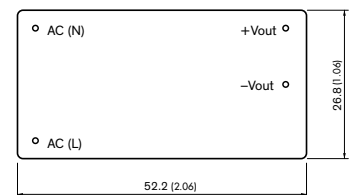

TPP 15A-J Series

- Universal input 90-264 VAC and 120-370 VDC
- Output voltages adjust $\pm 10\%$: 3.3, 5.0, 12, 15, 24, 48 VDC
- Protection class II prepared
- Low leakage current <math>< 75 \mu\text{A}</math>
- Operating temperature range -40°C to 85°C .
- Input filter to meet EN 55032 class B
- Available for PCB mount (-D) or with Pin-connector (-J)



www.tracopower.com/overview/tpp15a-j

15 Watt AC/DC open frame power supply

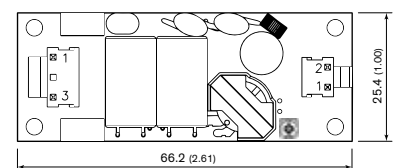
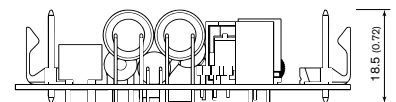

TPP 15A-D Series

NEW

15 Watt AC/DC open frame power supply

- Universal input 90-264 VAC and 120-370 VDC
- Output voltages adjust $\pm 10\%$: 3.3, 5.0, 12, 15, 24, 48 VDC
- Protection class II prepared
- Low leakage current $<75 \mu\text{A}$
- Operating temperature range -40°C to 85°C .
- Input filter to meet EN 55032 class B
- Available for PCB mount (-D) or with Pin-connector (-J)



- 1: AC (N)
- 2: AC (L)
- 3: Trim
- 4: -Vout
- 5: +Vout

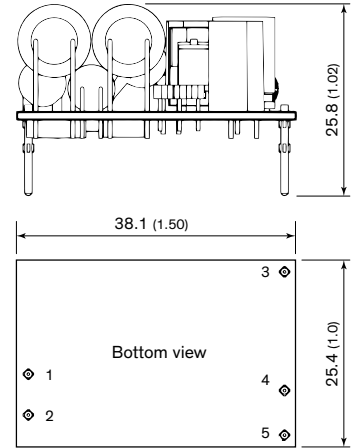

www.tracopower.com/overview/tpp15a-d

TPP 15-J Series

NEW

15 Watt AC/DC encapsulated power supply

- Universal input 90-264 VAC and 120-370 VDC
- Output voltages adjust $\pm 10\%$: 3.3, 5.0, 12, 15, 24, 48 VDC
- Protection class II prepared
- Low leakage current $<75 \mu\text{A}$
- Operating temperature range -40°C to 85°C .
- Input filter to meet EN 55032 class B
- Available for PCB mount (-D) or for chassis mount (-J)

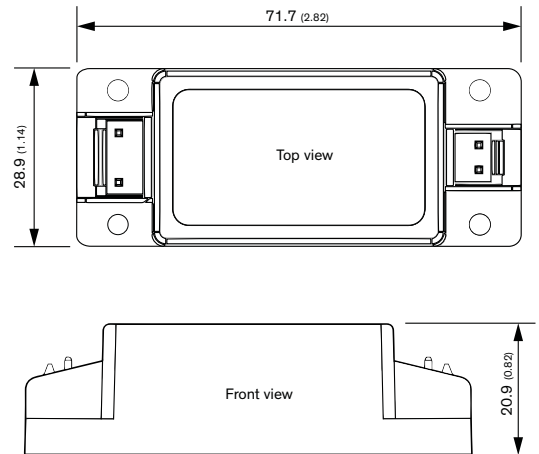

www.tracopower.com/overview/tpp15-j

TPP 15-D Series

NEW

15 Watt AC/DC encapsulated power supply

- Universal input 90-264 VAC and 120-370 VDC
- Output voltages adjust $\pm 10\%$: 3.3, 5.0, 12, 15, 24, 48 VDC
- Protection class II prepared
- Low leakage current $<75 \mu\text{A}$
- Operating temperature range -40°C to 85°C .
- Input filter to meet EN 55032 class B
- Available for PCB mount (-D) or for chassis mount (-J)



- 1: AC (N)
- 2: AC (L)
- 3: Trim
- 4: -Vout
- 5: +Vout

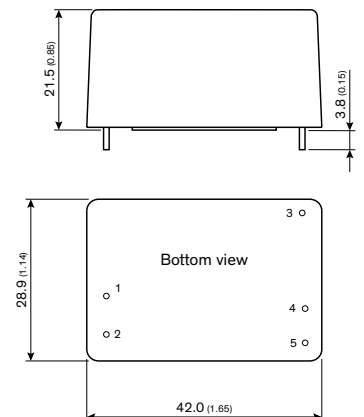

www.tracopower.com/overview/tpp15-d

TMF 20 Series

- Universal input 90-264 VAC and 120-370 VDC
- Output voltages:
5.0, 12, 15, 24 VDC
- Fully encapsulated ultra compact plastic casing for PCB mount
- Protection class II prepared
- Low leakage current <math>< 100 \mu\text{A}</math>
- Operating temperature range
-25°C to 70°C.
- Input filter to meet EN 55032 class B



www.tracopower.com/overview/tmf20

20 Watt AC/DC power module

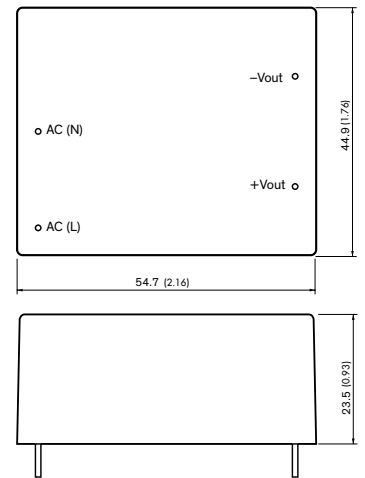

TMF 30 Series

- Universal input 90-264 VAC and 120-370 VDC
- Output voltages:
5.0, 12, 15, 24 VDC
- Fully encapsulated ultra compact plastic casing for PCB mount
- Protection class II prepared
- Low leakage current <math>< 100 \mu\text{A}</math>
- Operating temperature range
-25°C to 70°C.
- Input filter to meet EN 55032 class B



www.tracopower.com/overview/tmf30

30 Watt AC/DC power module

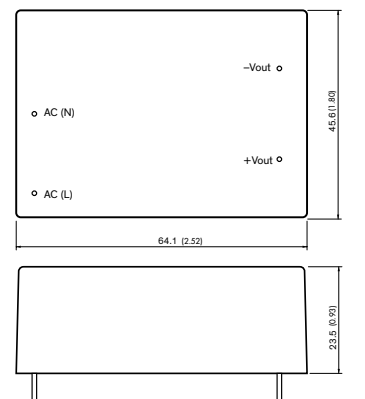

TPP 30A-J Series

- Universal input 90-264 VAC and 120-370 VDC
- Output voltages adjust $\pm 10\%$:
3.3, 5.0, 12, 15, 24, 36, 48 VDC
- Protection class II prepared
- Low leakage current <math>< 100 \mu\text{A}</math>
- Operating temperature range
-40°C to 85°C.
- Input filter to meet EN 55032 class B
- Available for PCB mount (-D)
or with Pin-connector (-J)



www.tracopower.com/overview/tpp30a-j

30 Watt AC/DC open frame power supply

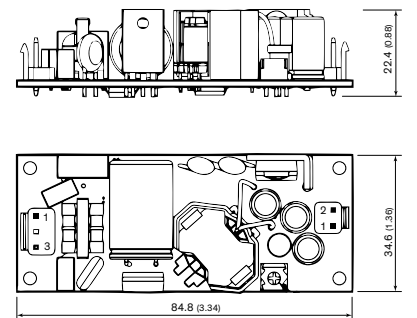

TPP 30A-D Series

NEW

30 Watt AC/DC open frame power supply

- Universal input 90-264 VAC and 120-370 VDC
- Output voltages adjust $\pm 10\%$: 3.3, 5.0, 12, 15, 24, 36, 48 VDC
- Protection class II prepared
- Low leakage current $< 100 \mu\text{A}$
- Operating temperature range -40°C to 85°C .
- Input filter to meet EN 55032 class B
- Available for PCB mount (-D) or with Pin-connector (-J)



- 1: AC (N)
- 2: AC (L)
- 3: +Vout
- 4: -Vout
- 5: Trim

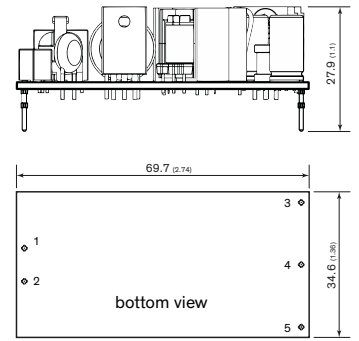

www.tracopower.com/overview/tpp30a-d

TPP 30-J Series

NEW

30 Watt AC/DC encapsulated power supply

- Universal input 90-264 VAC and 120-370 VDC
- Output voltages adjust $\pm 10\%$: 3.3, 5.0, 12, 15, 24, 36, 48 VDC
- Protection class II prepared
- Low leakage current $< 100 \mu\text{A}$
- Operating temperature range -40°C to 85°C .
- Input filter to meet EN 55032 class B
- Available for PCB mount (-D) or for chassis mount (-J)

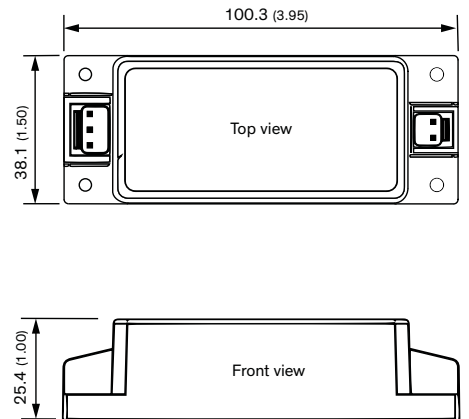

www.tracopower.com/overview/tpp30-j

TPP 30-D Series

NEW

30 Watt AC/DC encapsulated power supply

- Universal input 90-264 VAC and 120-370 VDC
- Output voltages adjust $\pm 10\%$: 3.3, 5.0, 12, 15, 24, 36, 48 VDC
- Protection class II prepared
- Low leakage current $< 100 \mu\text{A}$
- Operating temperature range -40°C to 85°C .
- Input filter to meet EN 55032 class B
- Available for PCB mount (-D) or for chassis mount (-J)



- 1: AC (N)
- 2: AC (L)
- 3: +Vout
- 4: -Vout
- 5: Trim

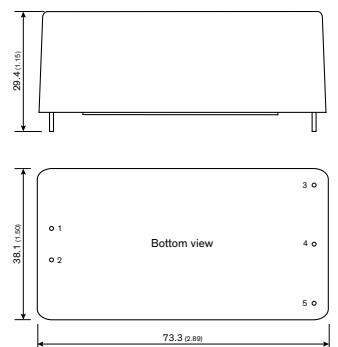

www.tracopower.com/overview/tpp30-d

TPP 40A Series

40 Watt AC/DC open frame power supply

- Universal input 85-264 VAC and 120-370 VDC
- Output voltages (Vout1 adjust. $\pm 10\%$)
single: 5.0, 12, 24, 48 VDC
- Highest efficiency (ErP ready)
- Protection class I & II prepared
- Low leakage current $< 75 \mu\text{A}$
- Optional: individual output voltage

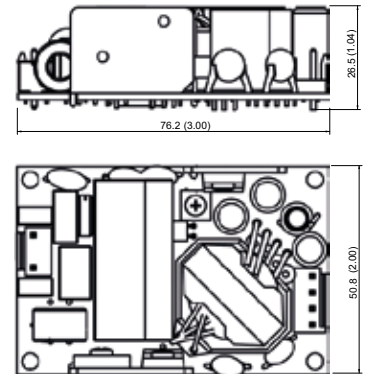

www.tracopower.com/overview/tpp40a

TPP 40 Series

40 Watt AC/DC metal enclosure power supply

- Universal input 85-264 VAC and 120-370 VDC
- Output voltages (Vout1 adjust. $\pm 10\%$)
single: 5.0, 12, 15, 24, 48 VDC
dual: 12/5, 15/5, 24/5 VDC
triple: $\pm 12/5$, $\pm 15/5$, 24/5/12 VDC
- Highest efficiency (ErP ready)
- Protection class II prepared
- Low leakage current $< 75 \mu\text{A}$
- Optional: DIN-rail, individual output voltages



Single output
L = 89.7 (3.53)
H = 33.3 (1.31)

Multi output
L = 102.4 (4.03)
H = 34.3 (1.36)

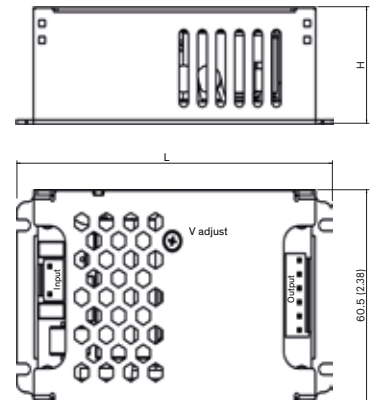

www.tracopower.com/overview/tpp40

TPP 65A Series

65 Watt AC/DC open frame power supply

- Universal input 85-264 VAC and 120-370 VDC
- Output voltages (Vout1 adjust. $\pm 10\%$)
single: 5.0, 12, 15, 24, 48 VDC
dual: 12/5, 15/5, 24/5 VDC
triple: $\pm 12/5$, $\pm 15/5$, 24/5/12 VDC
- Highest efficiency (ErP ready)
- Protection class II prepared
- Low leakage current $< 75 \mu\text{A}$
- Optional: individual output voltages

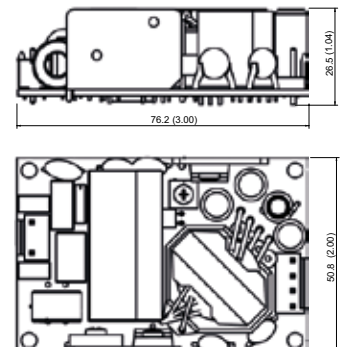

www.tracopower.com/overview/tpp65a

TPP 65 Series

65 Watt AC/DC metal enclosure power supply

- Universal input 85-264 VAC and 120-370 VDC
- Output voltages (Vout1 adjust. $\pm 10\%$)
single: 5.0, 12, 15, 24, 48 VDC
dual: 12/5, 15/5, 24/5 VDC
triple: $\pm 12/5$, $\pm 15/5$, 24/5/12 VDC
- Highest efficiency (ErP ready)
- Protection class II prepared
- Low leakage current $< 75 \mu\text{A}$
- Optional: Open frame, DIN-rail, individual output voltages



Single output
L = 89.7 (3.53)
H = 33.3 (1.31)

Multi output
L = 102.4 (4.03)
H = 34.3 (1.36)

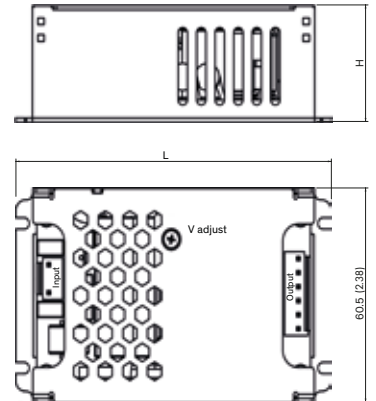

www.tracopower.com/overview/tpp65

TPP 100A Series

NEW

100 Watt AC/DC open frame power supply

- Universal input 85-264 VAC and 120-370 VDC
- Output voltages adjustable $\pm 10\%$:
12, 15, 24, 28, 36, 48 VDC
- Active power factor correction
- Highest efficiency (ErP ready)
- Protection class II prepared
- Low leakage current $< 75 \mu\text{A}$
- Optional: individual output voltages

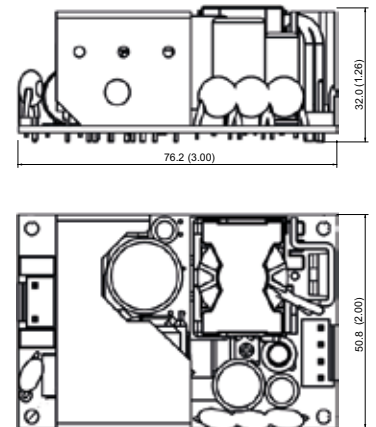

www.tracopower.com/overview/tpp100a-j

TPP 100 Series

100 Watt AC/DC metal enclosure power supply

- Universal input 85-264 VAC and 120-370 VDC
- Output voltages adjustable $\pm 10\%$:
12, 15, 24, 28, 36, 48 VDC
- Active power factor correction
- Highest efficiency (ErP ready)
- Protection class II prepared
- Low leakage current $< 75 \mu\text{A}$
- Optional: DIN-rail, individual output voltages

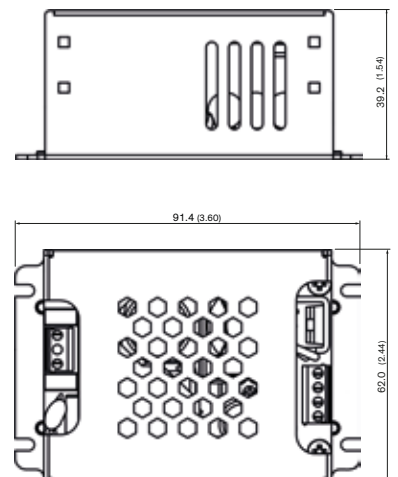

www.tracopower.com/overview/tpp100

TPP 150A Series

NEW

150 Watt AC/DC open frame power supply

- Universal input 85-264 VAC and 120-370 VDC
- Output voltages adjustable $\pm 10\%$: 12, 15, 24, 28, 36, 48 VDC
- Active power factor correction
- Highest efficiency (ErP ready)
- Protection class II prepared
- Low leakage current $< 75 \mu\text{A}$
- Optional: individual output voltages

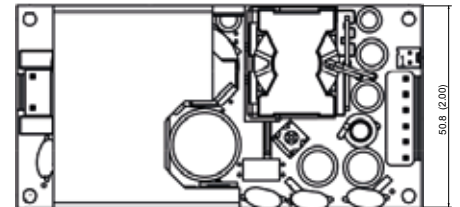
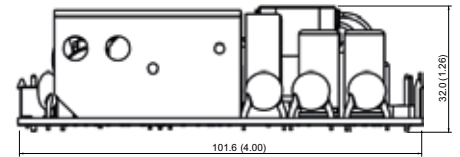

www.tracopower.com/overview/tpp150a-j

TPP 150 Series

150 Watt AC/DC metal enclosure power supply

- Universal input 85-264 VAC and 120-370 VDC
- Output voltages adjustable $\pm 10\%$: 12, 15, 24, 28, 36, 48 VDC
- Active power factor correction
- Highest efficiency (ErP ready)
- Protection class II prepared
- Low leakage current $< 75 \mu\text{A}$
- Optional: DIN-rail, individual output voltages

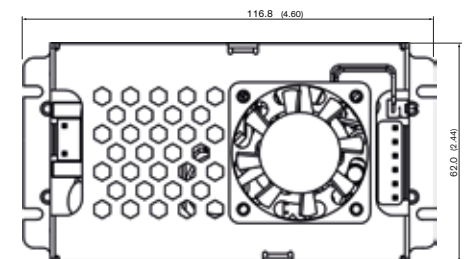
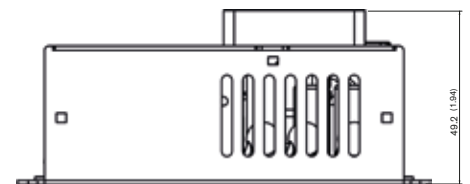

www.tracopower.com/overview/tpp150

TPP 180A Series

NEW

180 Watt AC/DC open frame power supply

- Universal input 85-264 VAC and 120-370 VDC
- Output voltages adjustable $\pm 10\%$: 12, 15, 24, 28, 36, 48 VDC
- Ultra compact design, high power density in 3" x 2" package
- Protection class II prepared
- Low leakage current $< 100 \mu\text{A}$
- Highest efficiency (ErP ready)
- Active power factor correction

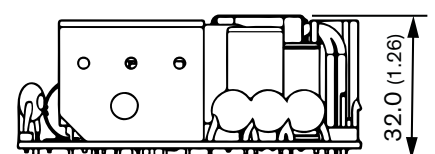
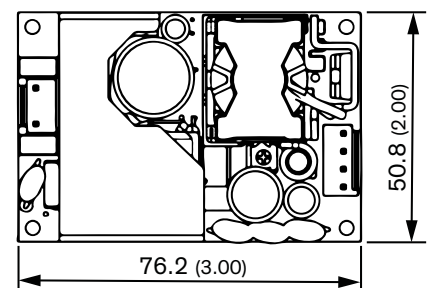

www.tracopower.com/overview/tpp180a

TPP 300A Series

NEW

300 Watt AC/DC open frame power supply

- Universal input 85-264 VAC and 120-370 VDC
- Output voltages adjustable $\pm 10\%$: 12, 15, 24, 28, 36, 48 VDC
- Ultra compact design, high power density in 3" x 2" package
- Protection class II prepared
- Low leakage current $< 100 \mu\text{A}$
- Highest efficiency (ErP ready)
- Active power factor correction

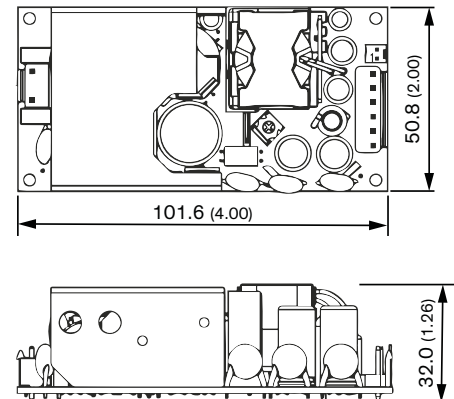

www.tracopower.com/overview/tpp300a

TPP 450A Series

NEW

450 Watt AC/DC open frame power supply

- High power density 3" x 5"
- 450 Watt with forced air cooling
320 Watt convection cooled without derating up to 50°C
- Additional IT (UL 62368-1) approvals
- Universal input 85-264 VAC and 120-370 VDC
- Output voltages adjustable $\pm 10\%$: 12, 15, 24, 28, 36, 48, 53 VDC
- Active power factor correction
- Highest efficiency (ErP ready)
- Protection class I
- Low leakage current $< 100 \mu\text{A}$
- Auxiliary output for fan

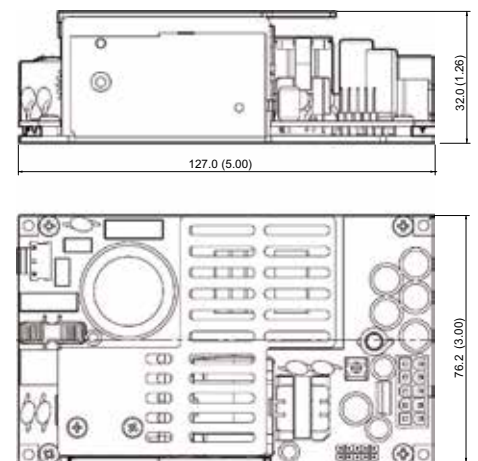

www.tracopower.com/overview/tpp450a

TPP 450 Series

NEW

450 Watt AC/DC metal enclosure power supply

- High power density 3" x 5.8"
- 450 Watt up to 65°C without derating
320 Watt fanless operation without derating up to 50°C
- Additional IT (UL 62368-1) approvals
- Universal input 85-264 VAC and 120-370 VDC
- Output voltages adjustable $\pm 10\%$: 12, 15, 24, 28, 36, 48, 53 VDC
- Active power factor correction
- Highest efficiency (ErP ready)
- Protection class I
- Low leakage current $< 100 \mu\text{A}$
- Temperature controlled fan

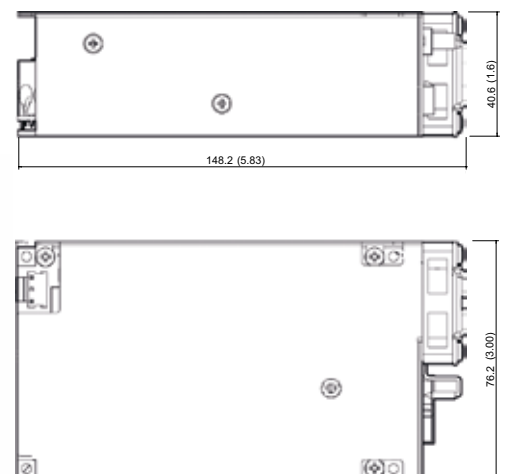

www.tracopower.com/overview/tpp450



With our design house

TRACO POWER SOLUTIONS Ltd.

we have the facility to expeditiously design customized power supplies and to manufacture prototypes and pre-series.

Our competences & services

- Research & design
- Commercial and technical support
- Pre-compliance safety and EMI test
- Mechanical and thermodynamic tests
- HALT and performance test
- 100% functional testing and burn-in
- Project attendance with external test and certification authorities
- Production of OEM and white label power supplies

TRACO POWER – dedicated to design and production of high quality, state-of-the-art DC/DC & AC/DC power conversion products. Our mission is to provide optimal power supply solutions for specific applications with regard to performance, quality, cost and functionality.

TRACO POWER stocks an average of USD 15+ million in available finished goods inventory for immediate shipment through our distribution partners.

TRACO POWER offers extended product life-cycles, typically 10+ years, and our medical products are supported by a 5 year product warranty.

We understand our customers require a high quality solution as well as a diverse product offering, availability from stock, extended life-cycles and a strong commitment to quality in the form of extended warranty to support their business.

International Office

Traco Electronic AG
Sihlbruggstrasse 111
6340 Baar
Switzerland

P +41 43 311 45 11
F +41 43 311 45 45
info@tracopower.com

German Office

Traco Electronic GmbH
Oskar-Messter-Str. 20a
85737 Ismaning/München
Germany

P +49 80 96 11 82-0
F +49 80 96 11 82-20
info@tracopower.de

French Office

Traco Power France
7, rue de la Vanne
92120 Montrouge
France

M +33 (0)6 72 11 52 21
info@tracopower.fr

North America Office

Traco Power North America, Inc.
2025 Gateway Place #330
SAN JOSE, CA 95110
USA

P +1 (408) 916-4570
F +1 (408) 916-4571
salesusa@tracopower.com

Design & Development

Traco Power Solutions Ltd.
Whitemill Industrial Estate
Whitemill Road, Wexford
Y35 YH66, Ireland

P +1 (408) 916-4570
F +1 (408) 916-4571
info@tracopower.ie