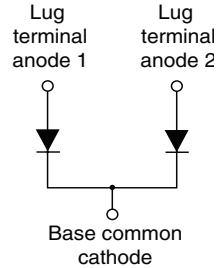

HEXFRED® Ultrafast Soft Recovery Diode, 210 A

TO-244

FEATURES

- Very low Q_{rr} and t_{rr}
- Lead (Pb)-free
- Designed and qualified for industrial level

**RoHS
COMPLIANT**
BENEFITS

- Reduced RFI and EMI
- Reduced snubbing

DESCRIPTION

HEXFRED® diodes are optimized to reduce losses and EMI/RFI in high frequency power conditioning systems. An extensive characterization of the recovery behavior for different values of current, temperature and di/dt simplifies the calculations of losses in the operating conditions. The softness of the recovery eliminates the need for a snubber in most applications. These devices are ideally suited for power converters, motors drives and other applications where switching losses are significant portion of the total losses.

PRODUCT SUMMARY

$I_{F(AV)}$	210 A
V_R	600 V
$I_{F(DC)}$ at T_C	120 A at 100 °C

ABSOLUTE MAXIMUM RATINGS

PARAMETER	SYMBOL	TEST CONDITIONS	MAX.	UNITS
Cathode to anode voltage	V_R		600	V
Continuous forward current	I_F	$T_C = 25\text{ °C}$	235	A
		$T_C = 100\text{ °C}$	120	
Single pulse forward current	I_{FSM}	Limited by junction temperature	600	
Non-repetitive avalanche energy	E_{AS}	$L = 100\text{ }\mu\text{H}$, duty cycle limited by maximum T_J	2.2	mJ
Maximum power dissipation	P_D	$T_C = 25\text{ °C}$	463	W
		$T_C = 100\text{ °C}$	185	
Operating junction and storage temperature range	T_J, T_{Stg}		- 55 to + 150	°C

ELECTRICAL SPECIFICATIONS PER LEG ($T_J = 25\text{ °C}$ unless otherwise specified)

PARAMETER	SYMBOL	TEST CONDITIONS	MIN.	TYP.	MAX.	UNITS
Cathode to anode breakdown voltage	V_{BR}	$I_R = 100\text{ }\mu\text{A}$	600	-	-	V
Maximum forward voltage	V_{FM}	$I_F = 105\text{ A}$	-	1.38	1.9	
		$I_F = 210\text{ A}$	-	1.6	2.25	
		$I_F = 105\text{ A}, T_J = 125\text{ °C}$	-	1.3	1.56	
Maximum reverse leakage current	I_{RM}	$T_J = 125\text{ °C}, V_R = 480\text{ V}$	-	1.8	6.0	mA
Junction capacitance	C_T	$V_R = 200\text{ V}$	-	200	300	pF
Series inductance	L_S	From top of terminal hole to mounting plane	-	6.0	-	nH

DYNAMIC RECOVERY CHARACTERISTICS (T _J = 25 °C unless otherwise specified)						
PARAMETER	SYMBOL	TEST CONDITIONS	MIN.	TYP.	MAX.	UNITS
Reverse recovery time See fig. 5	t _{rr}	I _F = 1.0 A, di _F /dt = 200 A/μs, V _R = 30 V	-	35	-	ns
		T _J = 25 °C	-	90	140	
		T _J = 125 °C	-	160	240	
Peak recovery current See fig. 6	I _{RRM}	T _J = 25 °C	-	10	18	A
		T _J = 125 °C	-	15	30	
Reverse recovery charge See fig. 7	Q _{rr}	T _J = 25 °C	-	450	1300	nC
		T _J = 125 °C	-	1200	3600	
Peak rate of recovery current See fig. 8	di _(rec) /dt	T _J = 25 °C	-	310	-	A/μs
		T _J = 125 °C	-	240	-	

THERMAL - MECHANICAL SPECIFICATIONS					
PARAMETER	SYMBOL	MIN.	TYP.	MAX.	UNITS
Maximum junction and storage temperature range	T _J , T _{Stg}	- 55	-	150	°C
Thermal resistance, junction to case	per leg	-	-	0.27	°C/W K/W
	per module	-	-	0.135	
Typical thermal resistance, case to heatsink	R _{thCS}	-	0.10	-	
Weight		-	68	-	g
		-	2.4	-	oz.
Mounting torque ⁽¹⁾		30 (3.4)	-	40 (4.6)	N · m (lbf · in)
Mounting torque center hole		12 (1.4)	-	18 (2.1)	
Terminal torque		30 (3.4)	-	40 (4.6)	
Vertical pull		-	-	80	lbf · in
2" lever pull		-	-	35	

Note

⁽¹⁾ Mounting surface must be smooth, flat, free of burrs or other protrusions. Apply a thin even film of thermal grease to mounting surface. Gradually tighten each mounting bolt in 5 to 10 lbf · in steps until desired or maximum torque limits are reached



HEXFRED®
Ultrafast Soft Recovery
Diode, 210 A

Vishay High Power Products

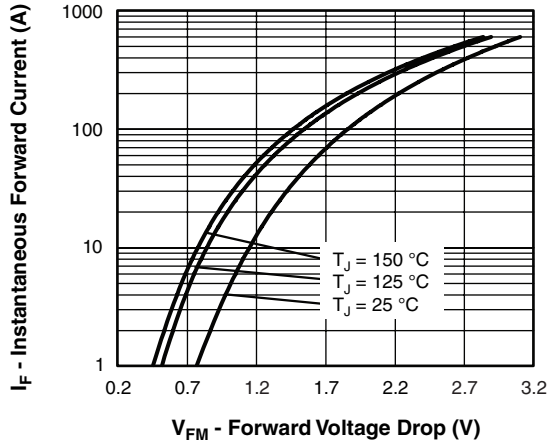

Fig. 1 - Maximum Forward Voltage Drop vs. Instantaneous Forward Current (Per Leg)

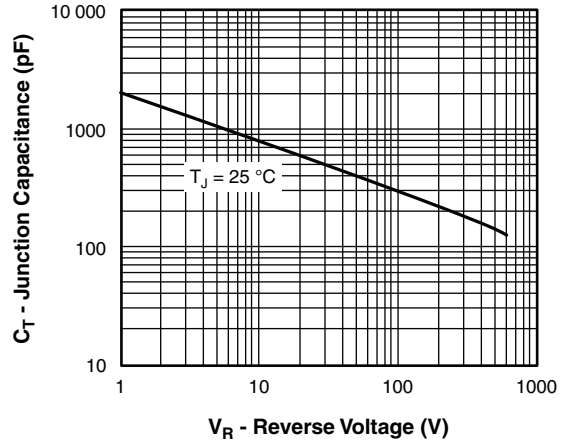

Fig. 3 - Typical Junction Capacitance vs. Reverse Voltage (Per Leg)

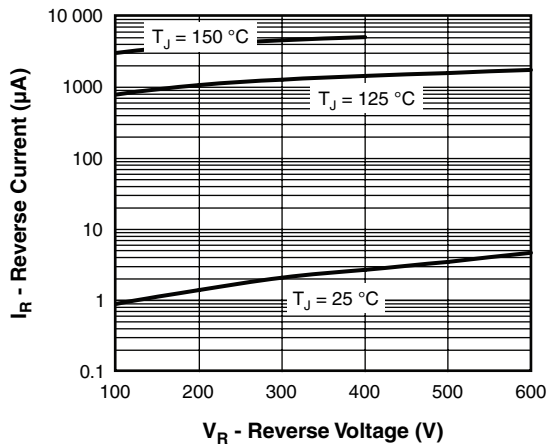

Fig. 2 - Typical Reverse Current vs. Reverse Voltage (Per Leg)

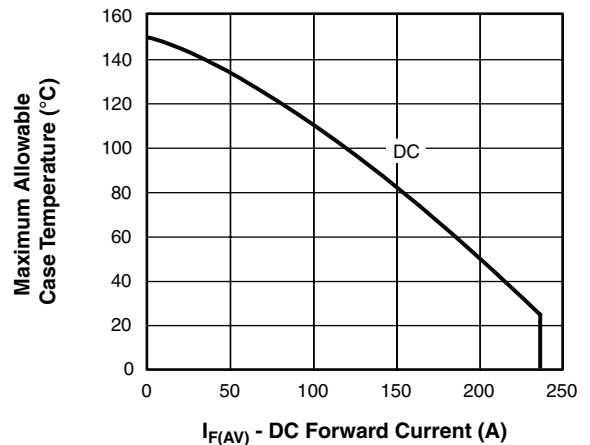

Fig. 4 - Maximum Allowable Case Temperature vs. DC Forward Current (Per Leg)

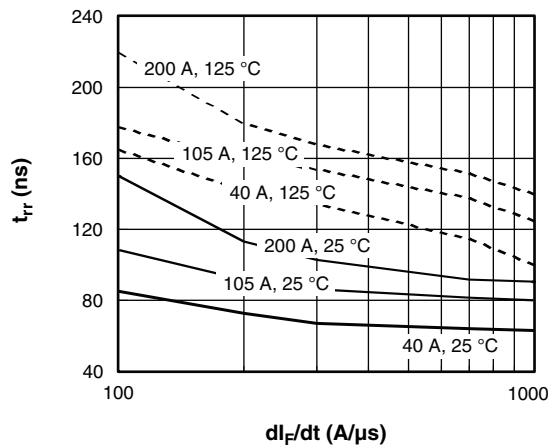

Fig. 5 - Typical Reverse Recovery Time vs. di_F/dt (Per Leg)

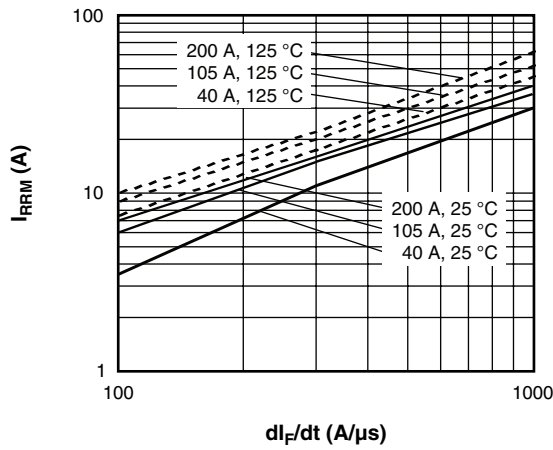

Fig. 6 - Typical Recovery Current vs. di_F/dt (Per Leg)

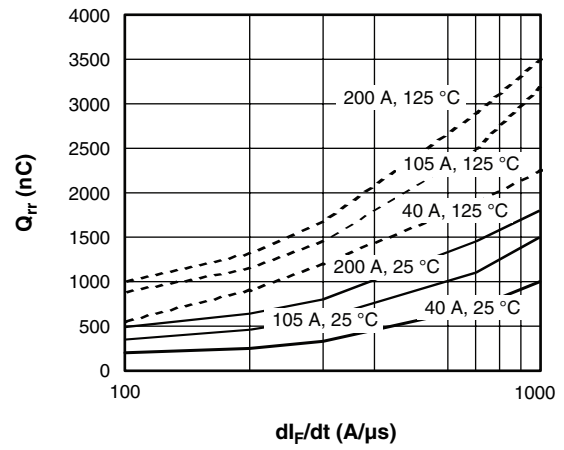

Fig. 7 - Typical Stored Charge vs. di_F/dt (Per Leg)

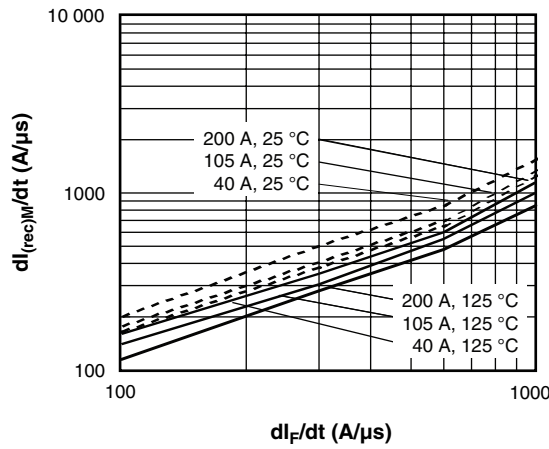

Fig. 8 - Typical $dl_{(rec)M}/dt$ vs. di_F/dt (Per Leg)

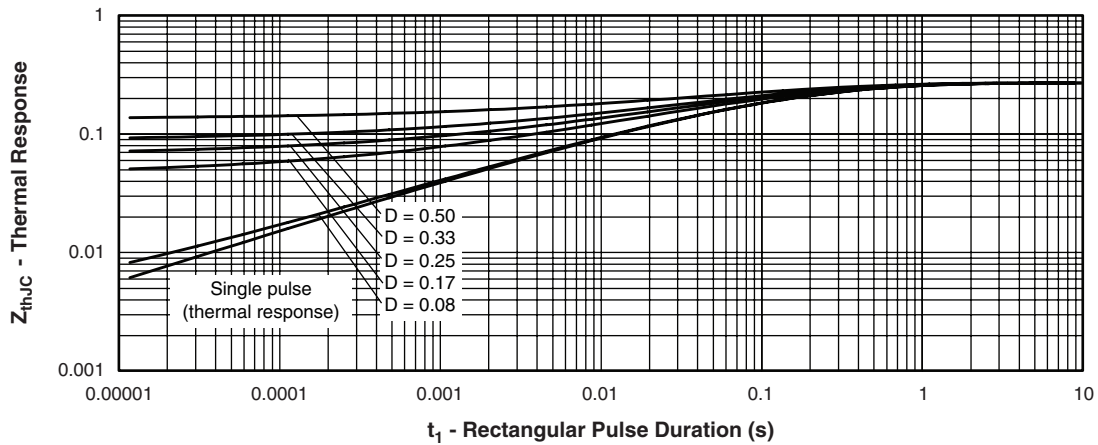

Fig. 9 - Maximum Thermal Impedance Z_{thJC} Characteristics (Per Leg)

HEXFRED®
 Ultrafast Soft Recovery
 Diode, 210 A

Vishay High Power Products

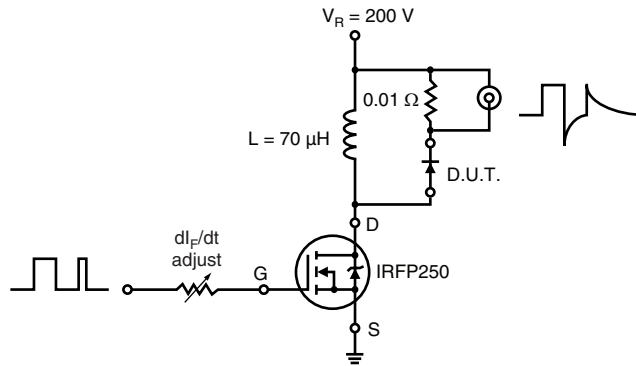
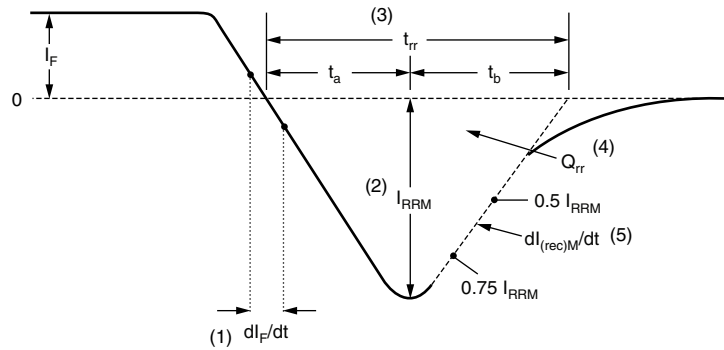

Fig. 10 - Reverse Recovery Parameter Test Circuit



- (1) di_F/dt - rate of change of current through zero crossing
- (2) I_{RRM} - peak reverse recovery current
- (3) t_{rr} - reverse recovery time measured from zero crossing point of negative going I_F to point where a line passing through $0.75 I_{RRM}$ and $0.50 I_{RRM}$ extrapolated to zero current.
- (4) Q_{rr} - area under curve defined by t_{rr} and I_{RRM}
- $$Q_{rr} = \frac{t_{rr} \times I_{RRM}}{2}$$
- (5) $di_{(rec)M}/dt$ - peak rate of change of current during t_b portion of t_{rr}

Fig. 11 - Reverse Recovery Waveform and Definitions

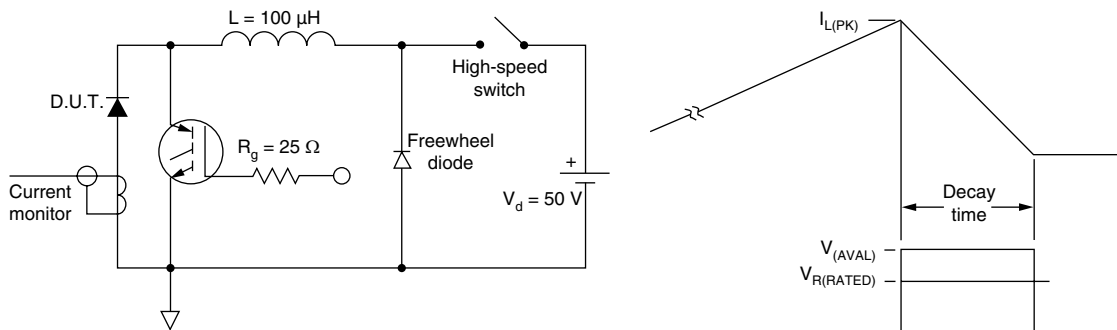

Fig. 12 - Avalanche Test Circuit and Waveforms

HFA210NJ60CPbF

Vishay High Power Products

HEXFRED®
Ultrafast Soft Recovery
Diode, 210 A



ORDERING INFORMATION TABLE

Device code	HFA	210	NJ	60	C	PbF
	①	②	③	④	⑤	⑥
1	-	HEXFRED® family, electron irradiated				
2	-	Average current rating				
3	-	NJ = TO-244				
4	-	Voltage rating (60 = 600 V)				
5	-	C = Common cathode				
6	-	Lead (Pb)-free				

LINKS TO RELATED DOCUMENTS

Dimensions	http://www.vishay.com/doc?95021
------------	---

TO-244

DIMENSIONS in millimeters (inches)

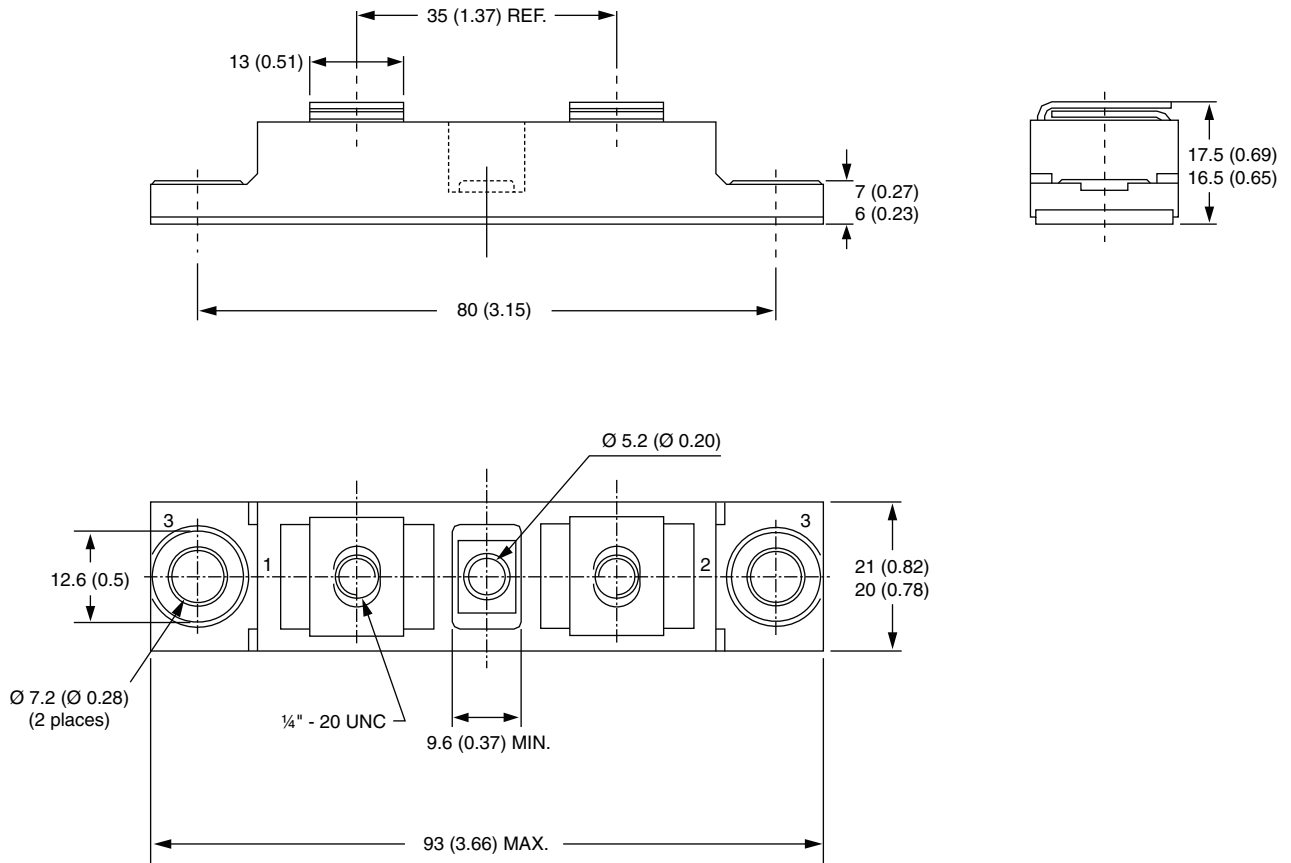



Disclaimer

ALL PRODUCT, PRODUCT SPECIFICATIONS AND DATA ARE SUBJECT TO CHANGE WITHOUT NOTICE TO IMPROVE RELIABILITY, FUNCTION OR DESIGN OR OTHERWISE.

Vishay Intertechnology, Inc., its affiliates, agents, and employees, and all persons acting on its or their behalf (collectively, "Vishay"), disclaim any and all liability for any errors, inaccuracies or incompleteness contained in any datasheet or in any other disclosure relating to any product.

Vishay makes no warranty, representation or guarantee regarding the suitability of the products for any particular purpose or the continuing production of any product. To the maximum extent permitted by applicable law, Vishay disclaims (i) any and all liability arising out of the application or use of any product, (ii) any and all liability, including without limitation special, consequential or incidental damages, and (iii) any and all implied warranties, including warranties of fitness for particular purpose, non-infringement and merchantability.

Statements regarding the suitability of products for certain types of applications are based on Vishay's knowledge of typical requirements that are often placed on Vishay products in generic applications. Such statements are not binding statements about the suitability of products for a particular application. It is the customer's responsibility to validate that a particular product with the properties described in the product specification is suitable for use in a particular application. Parameters provided in datasheets and/or specifications may vary in different applications and performance may vary over time. All operating parameters, including typical parameters, must be validated for each customer application by the customer's technical experts. Product specifications do not expand or otherwise modify Vishay's terms and conditions of purchase, including but not limited to the warranty expressed therein.

Except as expressly indicated in writing, Vishay products are not designed for use in medical, life-saving, or life-sustaining applications or for any other application in which the failure of the Vishay product could result in personal injury or death. Customers using or selling Vishay products not expressly indicated for use in such applications do so at their own risk and agree to fully indemnify and hold Vishay and its distributors harmless from and against any and all claims, liabilities, expenses and damages arising or resulting in connection with such use or sale, including attorneys fees, even if such claim alleges that Vishay or its distributor was negligent regarding the design or manufacture of the part. Please contact authorized Vishay personnel to obtain written terms and conditions regarding products designed for such applications.

No license, express or implied, by estoppel or otherwise, to any intellectual property rights is granted by this document or by any conduct of Vishay. Product names and markings noted herein may be trademarks of their respective owners.