

## Glass Passivated Single-Phase Bridge Rectifier

### Major Ratings and Characteristics

$I_{F(AV)}$	3 A
$V_{RRM}$	50 V to 1000 V
$I_{FSM}$	60 A
$I_R$	5 $\mu$ A
$V_F$	1.0 V
$T_j$ max.	150 °C

Case Style GBPC1

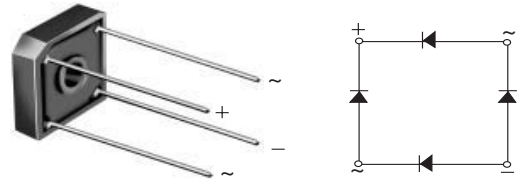

### Features

- UL Recognition file number E54214
- Ideal for printed circuit boards
- Typical  $I_R$  less than 0.1  $\mu$ A
- High surge current capability
- High case dielectric strength 1500  $V_{RMS}$
- Solder Dip 260 °C, 40 seconds



### Mechanical Data

**Case:** GBPC1

Epoxy meets UL-94V-0 Flammability rating

**Terminals:** Silver plated (E4 Suffix) leads, solderable per J-STD-002B and JESD22-B102D

**Polarity:** As marked, Positive lead by beveled corner

**Mounting Torque:** 10 cm-kg (8.8 inches-lbs) max.

**Recommended Torque:** 5.7 cm-kg (5 inches-lbs)

### Typical Applications

General purpose use in ac-to-dc bridge full wave rectification for Switching Power Supply, Home Appliances, Office Equipment, Industrial Automation applications

### Maximum Ratings

Ratings at 25 °C ambient temperature unless otherwise specified.

Parameter	Symbols	GBPC 1005	GBPC 101	GBPC 102	GBPC 104	GBPC 106	GBPC 108	GBPC 110	Units
Maximum repetitive peak reverse voltage	$V_{RRM}$	50	100	200	400	600	800	1000	V
Maximum RMS bridge input voltage	$V_{RMS}$	35	70	140	280	420	560	700	V
Maximum DC blocking voltage	$V_{DC}$	50	100	200	400	600	800	1000	V
Maximum average forward rectified output current at $T_C = 60$ °C <sup>(2)</sup> at $T_A = 25$ °C <sup>(3)</sup>	$I_{F(AV)}$	3.0 2.0							A
Peak forward surge current single sine-wave superimposed on rated load	$I_{FSM}$	60							A
Rating for fusing ( $t < 8.3$ ms)	$I^2t$	15							A <sup>2</sup> sec
Operating junction and storage temperature range	$T_J, T_{STG}$	- 55 to + 150							°C

### Electrical Characteristics

Ratings at 25 °C ambient temperature unless otherwise specified.

Parameter	Test condition	Symbols	GBPC 1005	GBPC 101	GBPC 102	GBPC 104	GBPC 106	GBPC 108	GBPC 110	Units
Maximum instantaneous forward voltage drop per leg	at 1.5 A	$V_F$	1.0							V

# GBPC1005 thru GBPC110



Vishay Semiconductors

Maximum DC reverse current at rated DC blocking voltage per leg	$T_A = 25\text{ }^\circ\text{C}$ $T_A = 125\text{ }^\circ\text{C}$	$I_R$	5.0 500	$\mu\text{A}$
Typical junction capacitance per leg	at 4.0 V, 1 MHz	$C_J$	21	pF

## Thermal Characteristics

Ratings at 25 °C ambient temperature unless otherwise specified.

Parameter	Symbols	GBPC 1005	GBPC 101	GBPC 102	GBPC 104	GBPC 106	GBPC 108	GBPC 110	Units
Typical thermal resistance per leg <sup>(1)</sup>	$R_{\theta JA}$	12							$^\circ\text{C/W}$
	$R_{\theta JC}$	8.0							

Notes:

- (1) Bolt down on heat-sink with silicone thermal compound between bridge and mounting surface for maximum heat transfer with #6 screw
- (2) Unit mounted on 4.0 x 4.0 x 0.11" thick (10.5 x 10.5 x 0.3 cm) Al. Plate
- (3) Unit mounted on P.C.B. at 0.375" (9.5 mm) lead length with 0.5 x 0.5" (12 x 12 mm) copper pads

## Ratings and Characteristics Curves

( $T_A = 25\text{ }^\circ\text{C}$  unless otherwise noted)

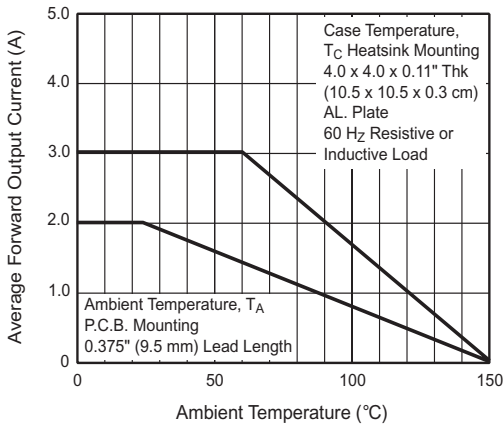

Figure 1. Derating Curve Output Rectified Current

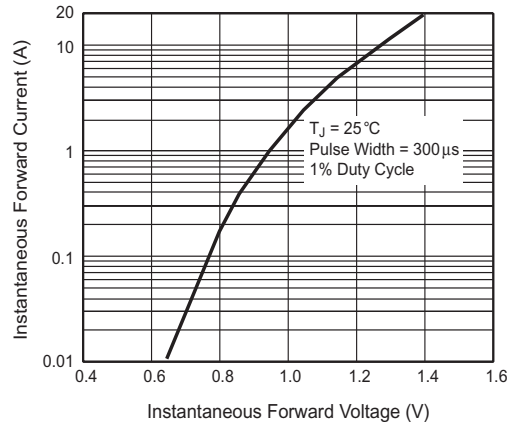

Figure 3. Typical Forward Characteristics Per Leg

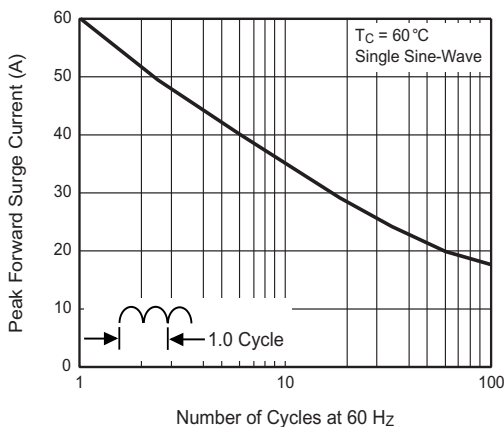

Figure 2. Maximum Non-Repetitive Peak Forward Surge Current Per Leg

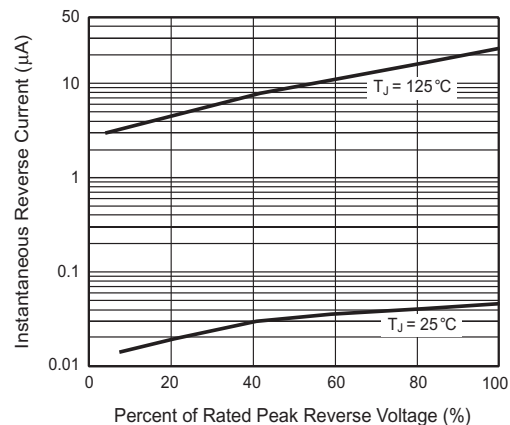

Figure 4. Typical Reverse Leakage Characteristics Per Leg

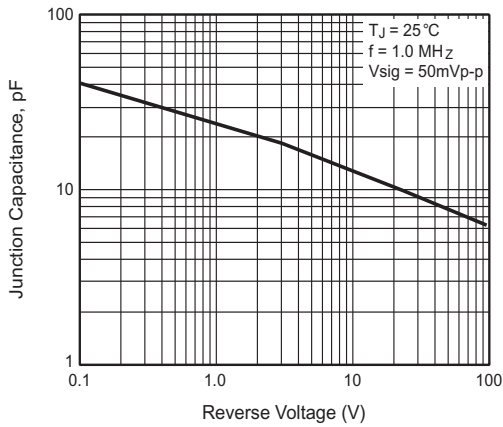

Figure 5. Typical Junction Capacitance Per Leg

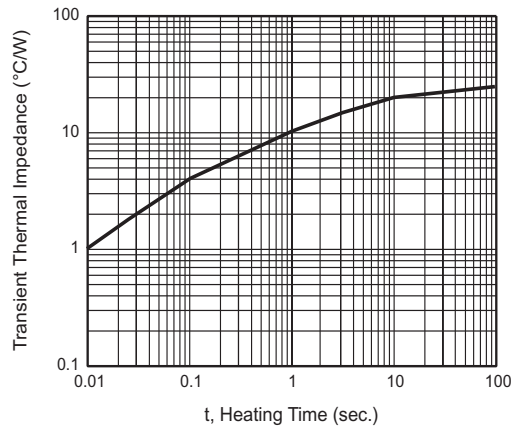
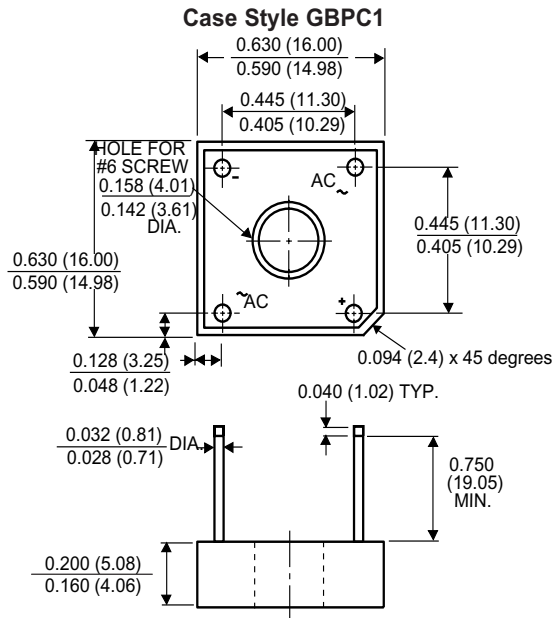

Figure 6. Typical Transient Thermal Impedance Per Leg

## Package outline dimensions in inches (millimeters)



Polarity shown on side of case: Positive lead by beveled corner