



Monolithic N-Channel JFET Dual

PRODUCT SUMMARY				
$V_{GS(off)}$ (V)	$V_{(BR)GSS}$ Min (V)	g_{fs} Min (mS)	I_G Typ (pA)	$ V_{GS1} - V_{GS2} $ Max (mV)
-1 to -6	-25	4.5	-1	20

FEATURES

- Monolithic Design
- High Slew Rate
- Low Offset/Drift Voltage
- Low Gate Leakage: 1 pA
- Low Noise
- High CMRR: 90 dB

BENEFITS

- Tight Differential Match vs. Current
- Improved Op Amp Speed, Settling Time Accuracy
- High-Speed Performance
- Minimum Input Error/Trimming Requirement
- Insignificant Signal Loss/Error Voltage
- High System Sensitivity
- Minimum Error with Large Input Signal

APPLICATIONS

- Wideband Differential Amps
- High-Speed, Temp-Compensated, Single-Ended Input Amps
- High Speed Comparators
- Impedance Converters

DESCRIPTION

The SST441 is a monolithic high-speed dual JFET mounted in a single SO-8 package. This JFET is an excellent choice for use as wideband differential amplifiers in demanding test and measurement applications.

The SO-8 package is available with tape-and-reel options to support automated assembly (see Packaging Information).

For similar products in TO-71 packaging, see the U441 data sheet.

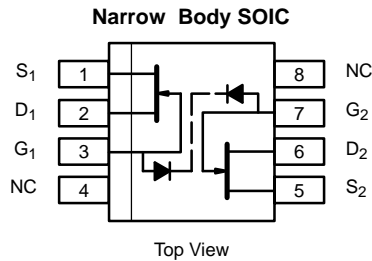

ABSOLUTE MAXIMUM RATINGS

Gate-Drain, Gate-Source Voltage -25 V
 Gate Current 50 mA
 Lead Temperature ($1/16$ " from case for 10 sec.) 300°C
 Storage Temperature -55 to 150°C

Operating Junction Temperature -55 to 150°C
 Power Dissipation : Per Side^a 300 mW
 Total^a 500 mW

Notes
 a. Derate 2.4 mW/°C above 25°C

For applications information see AN102.



SPECIFICATIONS (T _A = 25 °C UNLESS OTHERWISE NOTED)						
Parameter	Symbol	Test Conditions	Limits			Unit
			Min	Typ ^a	Max	
Static						
Gate-Source Breakdown Voltage	V _{(BR)GSS}	I _G = -1 μA, V _{DS} = 0 V	-25	-35		V
Gate-Source Cutoff Voltage	V _{GS(off)}	V _{DS} = 10 V, I _D = 1 nA	-1	-3.5	-6	
Saturation Drain Current ^b	I _{DSS}	V _{DS} = 10 V, V _{GS} = 0 V	6	15	30	mA
Gate Reverse Current	I _{GSS}	V _{GS} = -15 V, V _{DS} = 0 V		-1	-500	pA
		T _A = 125 °C		-0.2		nA
Gate Operating Current	I _G	V _{DG} = 10 V, I _D = 5 mA		-1	-500	pA
		T _A = 125 °C		-0.2		nA
Gate-Source Forward Voltage	V _{GS(F)}	I _G = 1 mA, V _{DS} = 0 V		0.7		V
Dynamic						
Common-Source Forward Transconductance	g _{fs}	V _{DS} = 10 V, I _D = 5 mA f = 1 kHz	4.5	6	9	mS
Common-Source Output Conductance	g _{os}				20	200
Common-Source Forward Transconductance	g _{fs}	V _{DS} = 10 V, I _D = 5 mA f = 100 MHz		5.5		mS
Common-Source Output Conductance	g _{os}				30	
Common-Source Input Capacitance	C _{iss}	V _{DS} = 10 V, I _D = 5 mA f = 1 MHz		3.5		pF
Common-Source Reverse Transfer Capacitance	C _{rss}				1	
Equivalent Input Noise Voltage	e _n	V _{DS} = 10 V, I _D = 5 mA f = 10 kHz		4		nV/ √Hz
Matching						
Differential Gate-Source Voltage	V _{GS1} - V _{GS2}	V _{DG} = 10 V, I _D = 5 mA		7	20	mV
Gate-Source Voltage Differential Change with Temperature	$\frac{\Delta V_{GS1} - V_{GS2} }{\Delta T}$	V _{DG} = 10 V, I _D = 5 mA T _A = -55 to 125 °C		10		μV/°C
Saturation Drain Current Ratio ^c	$\frac{I_{DSS1}}{I_{DSS2}}$	V _{DS} = 10 V, V _{GS} = 0 V		0.98		
Transconductance Ratio ^c	$\frac{g_{fs1}}{g_{fs2}}$	V _{DS} = 10 V, I _D = 5 mA f = 1 kHz		0.98		
Common Mode Rejection Ratio	CMRR	V _{DG} = 10 to 15 V, I _D = 5 mA		90		dB

Notes

- a. Typical values are for DESIGN AID ONLY, not guaranteed nor subject to production testing.
 b. Pulse test: PW ≤ 300 μs duty cycle ≤ 3%.
 c. Assumes smaller value in the numerator.

NNZ

TYPICAL CHARACTERISTICS ($T_A = 25^\circ\text{C}$ UNLESS OTHERWISE NOTED)

Drain Current and Transconductance vs. Gate-Source Cutoff Voltage

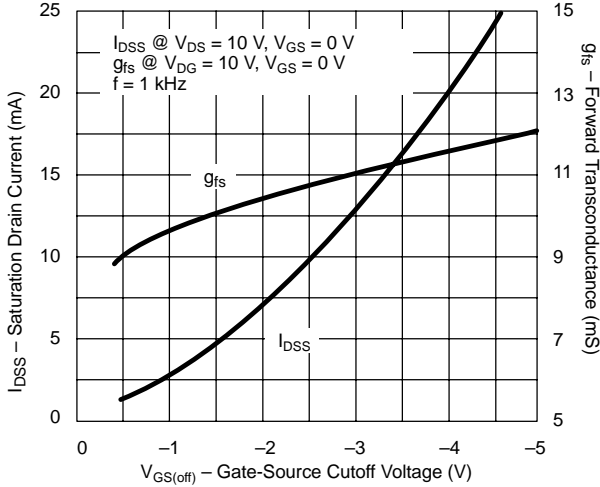

Gate Leakage Current

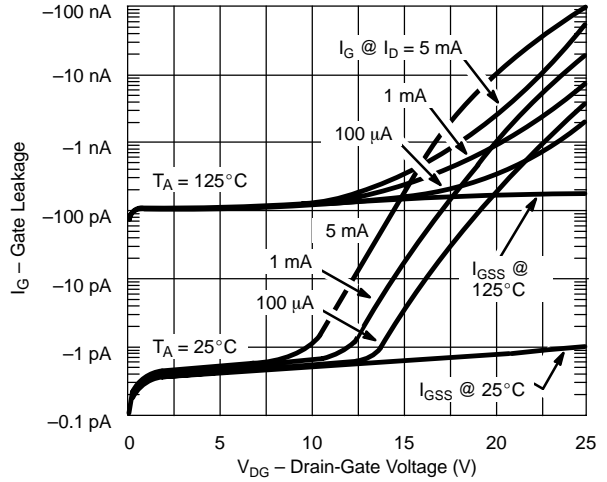

Output Characteristics

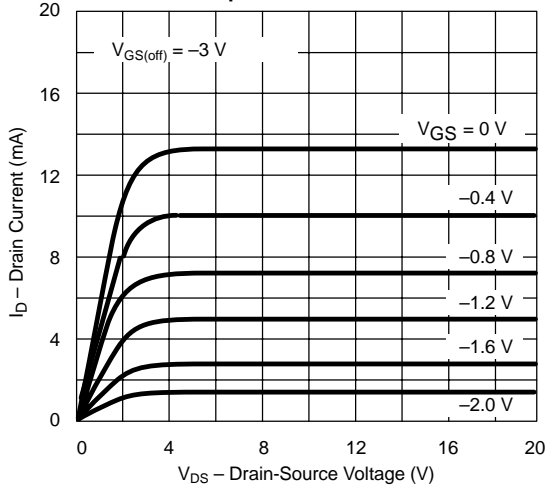

Output Characteristics

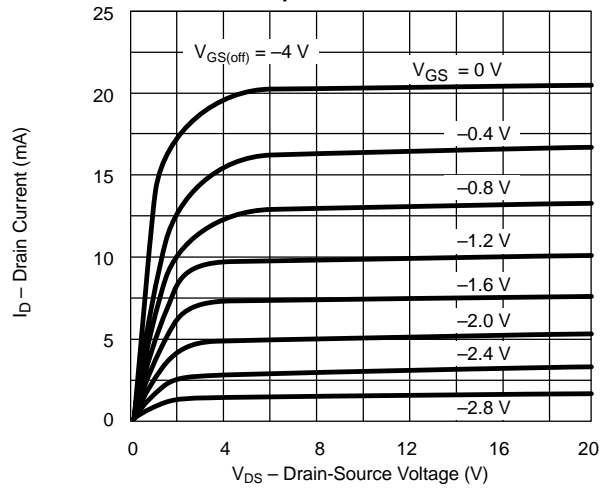

Output Characteristics

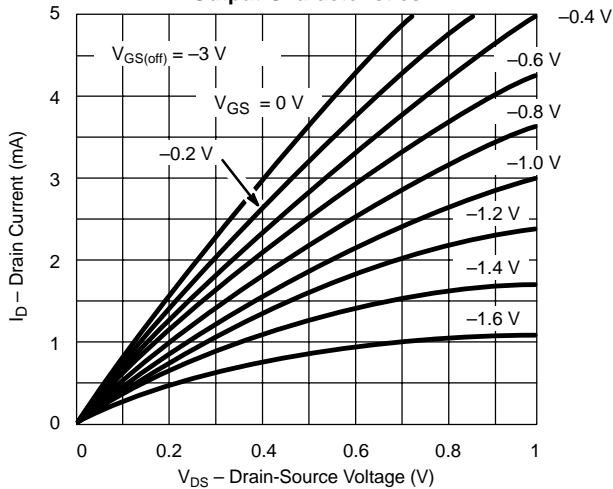

Output Characteristics

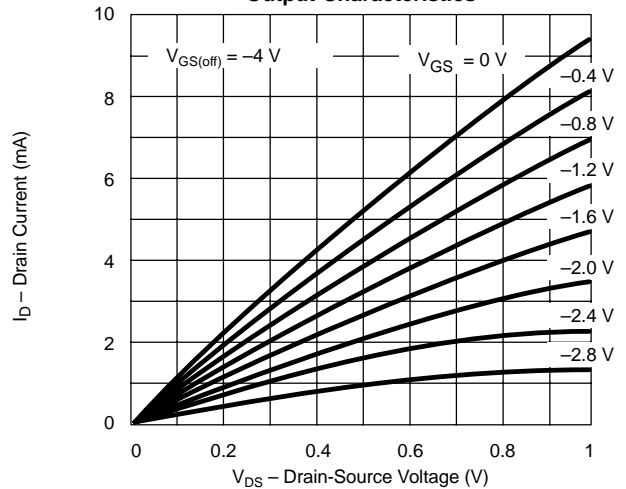



TYPICAL CHARACTERISTICS (T_A = 25°C UNLESS OTHERWISE NOTED)

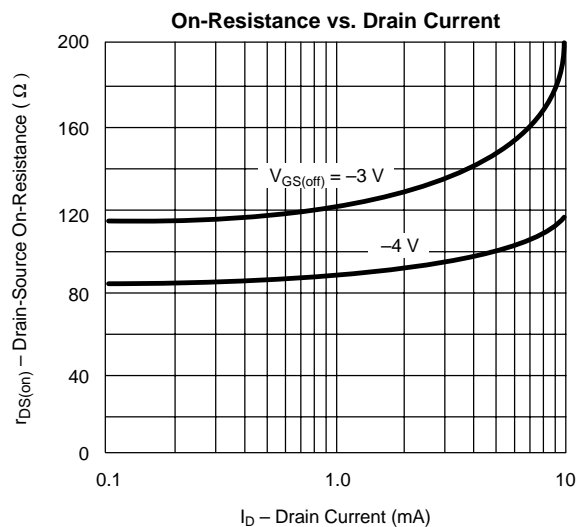
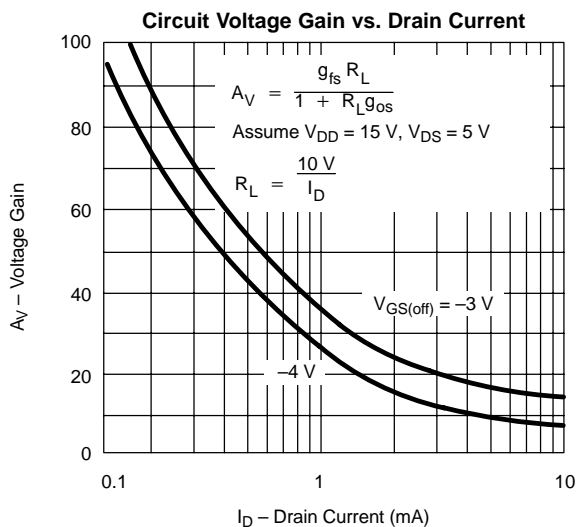
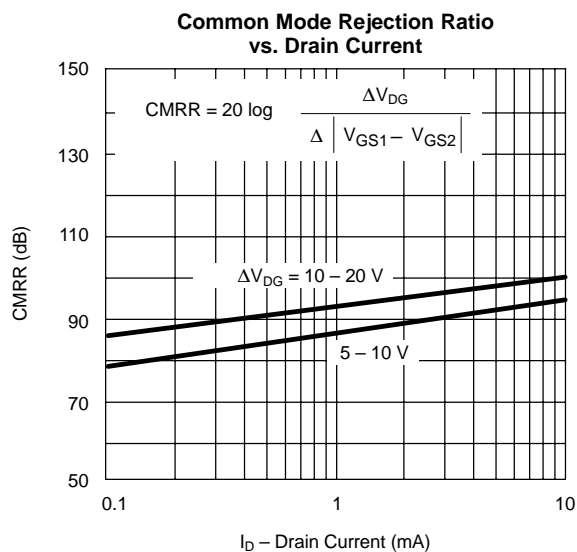
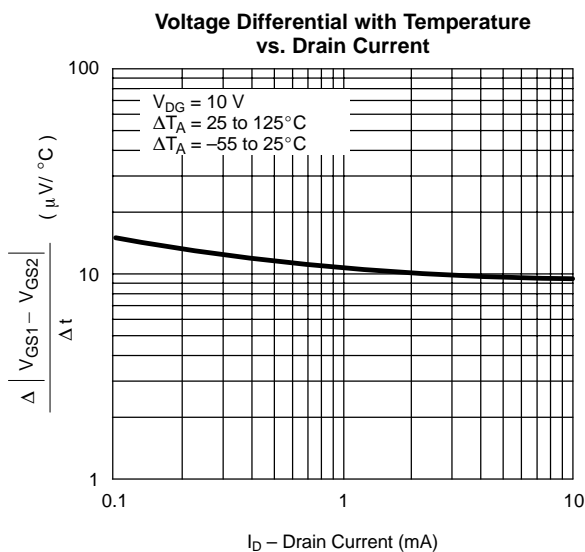
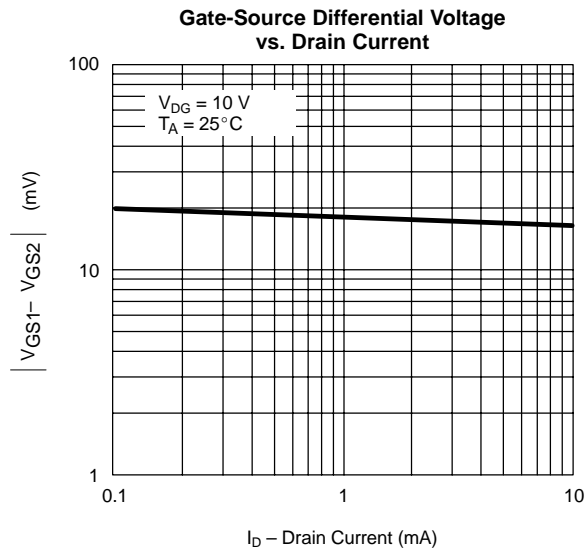
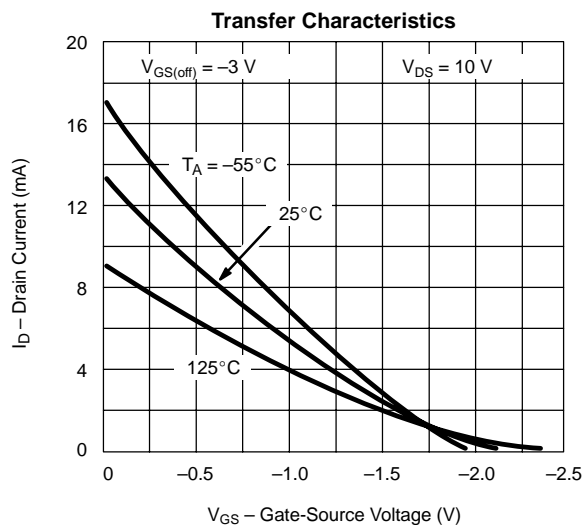

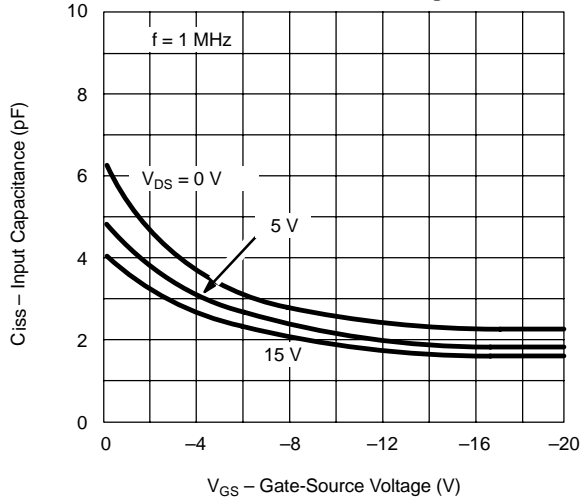
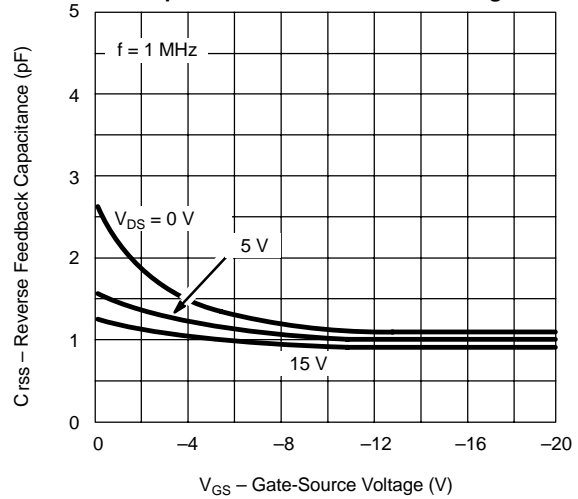
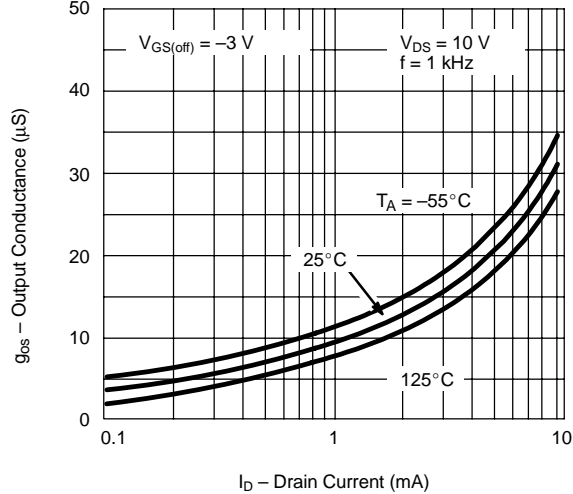
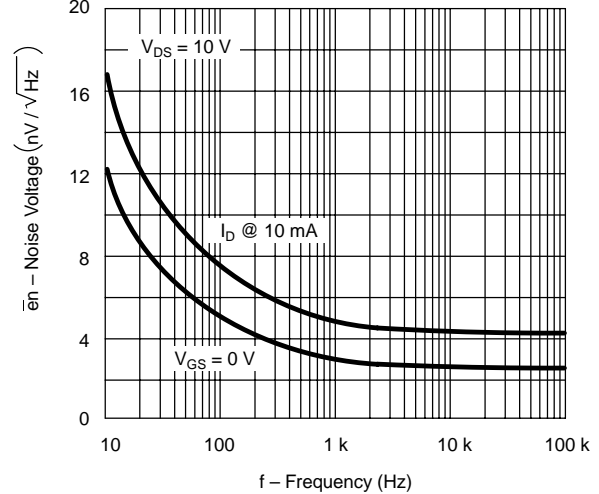
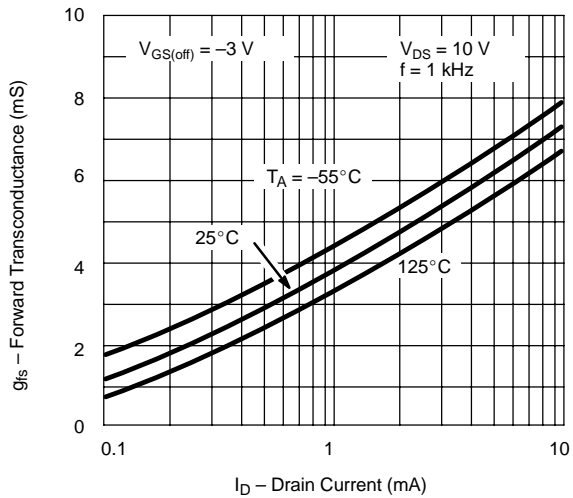
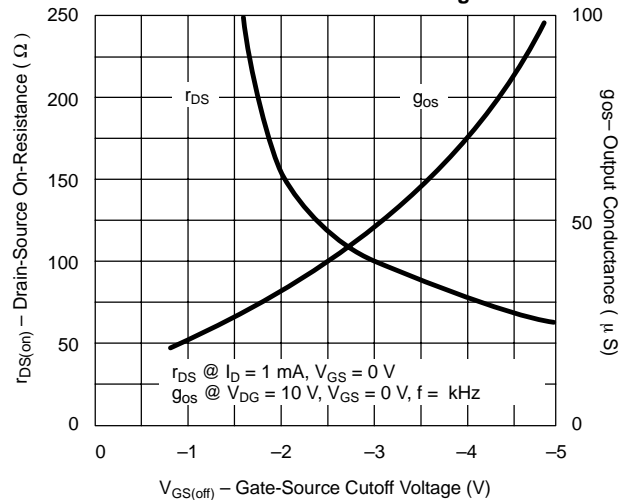
TYPICAL CHARACTERISTICS ($T_A = 25^\circ\text{C}$ UNLESS OTHERWISE NOTED)
Common-Source Input Capacitance vs. Gate-Source Voltage

Common-Source Reverse Feedback Capacitance vs. Gate-Source Voltage

Output Conductance vs. Drain Current

Equivalent Input Noise Voltage vs. Frequency

Common-Source Forward Transconductance vs. Drain Current

On-Resistance and Output Conductance vs. Gate-Source Cutoff Voltage



Notice

Specifications of the products displayed herein are subject to change without notice. Vishay Intertechnology, Inc., or anyone on its behalf, assumes no responsibility or liability for any errors or inaccuracies.

Information contained herein is intended to provide a product description only. No license, express or implied, by estoppel or otherwise, to any intellectual property rights is granted by this document. Except as provided in Vishay's terms and conditions of sale for such products, Vishay assumes no liability whatsoever, and disclaims any express or implied warranty, relating to sale and/or use of Vishay products including liability or warranties relating to fitness for a particular purpose, merchantability, or infringement of any patent, copyright, or other intellectual property right.

The products shown herein are not designed for use in medical, life-saving, or life-sustaining applications. Customers using or selling these products for use in such applications do so at their own risk and agree to fully indemnify Vishay for any damages resulting from such improper use or sale.