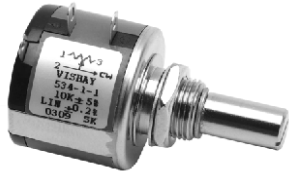

7/8" (22.2 mm) Multiturn Wirewound

533: 3 Turns/534: 10 Turns/535: 5 Turns

Note

- The color of this product may either be black (US market) or blue (other regions)

FEATURES

- Bushing and servo mount designs available
- Special resistance tolerances to 1 %
- Rear shaft extensions and support bearing
- Metric shaft available
- Dual gang configuration and concentric shafts
- High torque, center tap, slipping clutch on request
- Special markings and front shaft extensions

RoHS
COMPLIANT

ELECTRICAL SPECIFICATIONS			
PARAMETER	MODEL 533	MODEL 534	MODEL 535
Resistance Range - Standard Values	50 Ω to 20 kΩ	100 Ω to 100 kΩ	50 Ω to 50 kΩ
Capability Range	5 Ω to 60 kΩ	10 Ω to 200 kΩ	5 Ω to 100 kΩ
Standard Tolerance	± 5 %	± 5 %	± 5 %
Linearity (Independent)	± 0.25 %	± 0.25 %	± 0.25 %
Noise	100 Ω ENR	100 Ω ENR	100 Ω ENR
Rotation (Electrical and Mechanical)	1080° +10° -0°	3600° +10° -0°	1800° +10° -0°
Power Rating (at 70 °C)	1.0 W	2.0 W	1.5 W
Insulation Resistance	1000 MΩ minimum 500 V _{DC}		
Dielectric Strength	1000 V _{RMS} minimum 60 Hz		
Absolute Minimum Resistance	Not to exceed linearity x total resistance or 1 Ω, whichever is greater		
Temperature Coefficient	20 ppm/°C (standard values, wire only)		
End Voltage	0.25 % of total applied voltage, maximum		
Phasing	CCW end points - section 2 phased to section 1 within ± 2°		
Taps	Center tap only		

MARKING	
Unit Identification	Manufacturer's name and model number, resistance value and tolerance, linearity specification date code and terminal identification

RESISTANCE VALUES	
Ohms 533:	50R, 100R, 200R, 500R, 1K, 2K, 5K, 10K, 20K
534:	100R, 200R, 500R, 1K, 2K, 5K, 10K, 20K, 50K, 100K
535:	50R, 100R, 200R, 500R, 1K, 2K, 5K, 10K, 20K, 50K

ORDERING INFORMATION/DESCRIPTION								
The Models 533 (3 turns), 534 (10 turns) and 535 (5 turns) can be ordered by stating								
534	B	2	10K	20K	5 %	C	BO10	e4
MODEL	MOUNTING	NUMBER OF SECTIONS	OHMIC VALUE SECTION N° 1	OHMIC VALUE SECTION N° 2	TOLERANCE ON OHMIC VALUE	LINEARITY ± 0.25 %	PACKAGING Box of 10 pieces	LEAD FINISH
	B: Bushing S: Servo							

SAP PART NUMBERING GUIDELINES							
534	B	2	103	203	J	C	B10
MODEL	STYLE	NUMBER OF SECTIONS	OHMIC VALUE SECTION N° 1	OHMIC VALUE SECTION N° 2	TOLERANCE ON OHMIC VALUE	LINEARITY	PACKAGING
	B: Bushing S: Servo		103 = 10K	203 = 20K	J: ± 5 % F: ± 1 %	C: ± 0.25 % D: ± 0.10 %	Box of 10 pieces

Model 533, 534, 535



Vishay Spectrol

7/8" (22.2 mm) Multiturn Wirewound
533: 3 Turns/534: 10 Turns/535: 5 Turns

SINGLE SECTION DIMENSIONS in inches (millimeters)

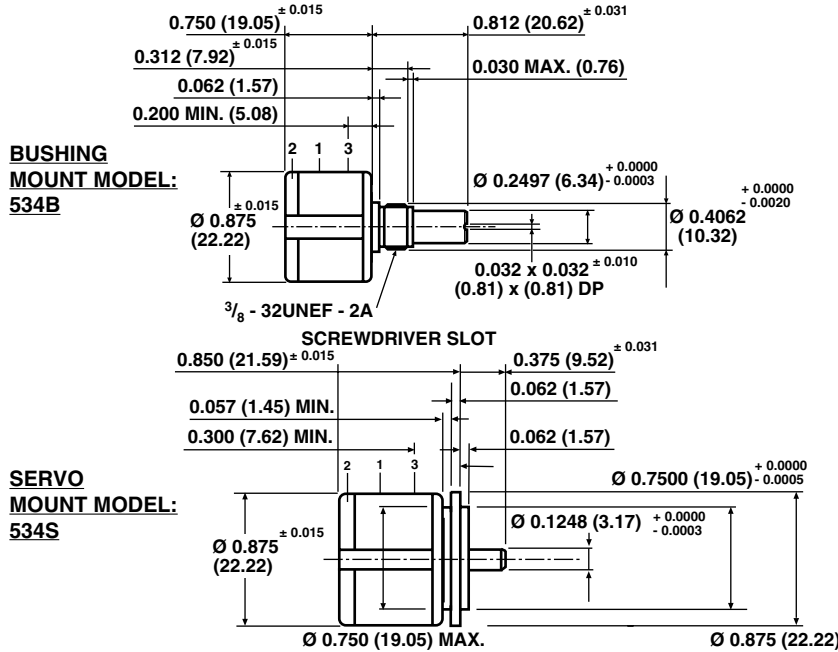

Mounting hardware, washer and panel nut, nickel plated

MECHANICAL SPECIFICATIONS		
PARAMETER		
Bearing Type	Bushing: Sleeve bearing	Servo: Ball bearing
Torque (Maximums): Starting		
Section 1	534 0.5 oz. - in (36 g - cm)	533/535 0.7 oz. - in (50 g - cm)
Section 2	0.9 oz. - in (65 g - cm)	1.1 oz. - in (79 g - cm)
Torque (Maximums): Running		
Section 1	534 0.4 oz. - in (28.80 g - cm)	533/535 0.6 oz. - in (43.20 g - cm)
Section 2	0.7 oz. - in (50.40 g - cm)	0.9 oz. - in (64.8 g - cm)
Weight (Maximums)		
Section 1	0.75 oz. (21.26 g)	
Section 2	1.25 oz. (35.44 g)	
Stop Strength	75 oz. - in (static) (5.4 kg - cm)	
Ganging	2 sections maximum	

POWER RATING CHART

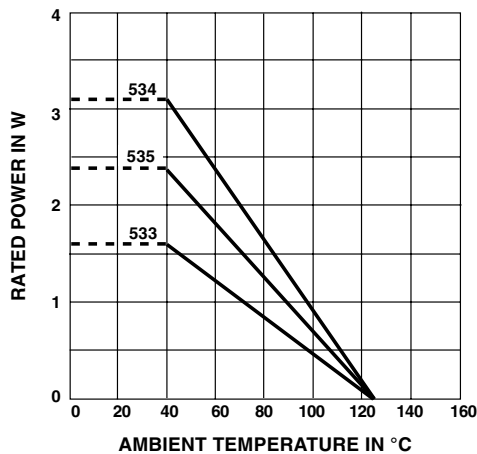

ENVIRONMENTAL SPECIFICATIONS	
Vibration	15 g thru 2000 Hz
Shock	50 g
Rotational Life (Shaft Revolution)	
533	300 000
534	1 000 000
534 (Servo)	> 1 000 000
535	500 000
Load Life	900 h
Temperature Range	- 55 °C to + 125 °C



$\frac{7}{8}$ " (22.2 mm) Multiturn Wirewound
 533: 3 Turns/534: 10 Turns/535: 5 Turns

Vishay Spectrol

RESISTANCE ELEMENT DATA														
RESISTANCE VALUE (Ω)			RESOLUTION %			OHMS PER TURN			MAXIMUM CURRENT AT 70 °C AMBIENT (mA)			MAXIMUM VOLTAGE ACROSS COIL (V)		
533	534	535	533	534	535	533	534	535	533	534	535	533	534	535
50	-	50	0.149	-	0.120	0.0746	-	0.0603	141.0	-	173.0	7.07	-	8.66
100	100	100	0.111	0.060	0.075	0.1114	0.0603	0.0746	100.0	141.0	122.0	10.0	14.1	12.2
200	200	200	0.097	0.037	0.061	0.1954	0.0746	0.1220	70.7	100.0	86.6	14.1	20.0	17.3
500	500	500	0.069	0.031	0.049	0.3424	0.1520	0.2459	44.7	63.2	54.7	22.4	31.6	27.4
1K	1K	1K	0.063	0.025	0.041	0.6331	0.2459	0.4113	31.6	44.7	38.7	31.6	44.7	38.7
2K	2K	2K	0.041	0.021	0.031	0.8206	0.4113	0.6331	22.4	31.6	27.4	44.7	63.2	54.8
5K	5K	5K	0.044	0.016	0.034	2.2330	0.8206	1.7230	14.1	20.0	17.3	70.7	100.0	86.6
10K	10K	10K	0.034	0.017	0.030	3.4510	1.7230	3.0160	10.0	14.1	12.2	100.0	141.0	122.0
20K	20K	20K	0.031	0.015	0.020	6.1790	3.0160	3.9910	7.07	10.0	8.66	141.0	200.0	173.0
-	50K	50K	-	0.009	0.015	-	4.6690	7.4560	-	6.32	5.47	-	316.0	274.0
-	100K	-	-	0.007	-	-	7.4560	-	-	4.47	-	-	447.0	-
-	-	-	-	-	-	-	-	-	-	-	-	-	-	-
-	-	-	-	-	-	-	-	-	-	-	-	-	-	-



Disclaimer

All product specifications and data are subject to change without notice.

Vishay Intertechnology, Inc., its affiliates, agents, and employees, and all persons acting on its or their behalf (collectively, "Vishay"), disclaim any and all liability for any errors, inaccuracies or incompleteness contained herein or in any other disclosure relating to any product.

Vishay disclaims any and all liability arising out of the use or application of any product described herein or of any information provided herein to the maximum extent permitted by law. The product specifications do not expand or otherwise modify Vishay's terms and conditions of purchase, including but not limited to the warranty expressed therein, which apply to these products.

No license, express or implied, by estoppel or otherwise, to any intellectual property rights is granted by this document or by any conduct of Vishay.

The products shown herein are not designed for use in medical, life-saving, or life-sustaining applications unless otherwise expressly indicated. Customers using or selling Vishay products not expressly indicated for use in such applications do so entirely at their own risk and agree to fully indemnify Vishay for any damages arising or resulting from such use or sale. Please contact authorized Vishay personnel to obtain written terms and conditions regarding products designed for such applications.

Product names and markings noted herein may be trademarks of their respective owners.



7/8" (22mm) Precision Wirewound Potentiometer

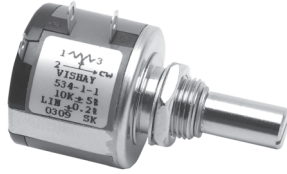

ADDITIONAL FEATURES

- Special Resistance Tolerances to 1%
- Rear Shaft Extensions and Support Bearing
- Non Turn Lug
- Dual Gang Configuration and Concentric Shafts
- High Torque and Center Tap
- Special Markings and Front Shaft Extensions
- Servo Unit available and Slipping Clutch

Note: The color of this product is changing to blue, during the internal period you may receive either black or blue.

ELECTRICAL SPECIFICATIONS			
PARAMETER	MODEL 533	MODEL 534	MODEL 535
Resistance Range Standard Values	50Ω to 20KΩ	100Ω to 100KΩ	50Ω to 50KΩ
Capability Range	5Ω to 60KΩ	10Ω to 200KΩ	5Ω to 100KΩ
Standard Tol	± 5%	± 5%	± 5%
Linearity (Independent)	± 0.25%	0.20%	± 0.25%
Noise	100Ω ENR	100Ω ENR	100Ω ENR
Rotation (Electrical & Mechanical)	1080° + 10%	3600° + 10%	1800° ± 10°
Power Rating (@ 70°C)	1.0 watts	2.0 watts	1.5 watts
Insulation Resistance	1000MΩ minimum 500VDC		
Dielectric Strength	1000V _{RMS} minimum 60Hz		
Absolute Minimum Resistance	Not to exceed linearity x total resistance or 1Ω, whichever is greater		
Tempco	20ppm/°C (standard values, wire only)		
End Voltage	0.25% of total applied voltage, maximum		
Phasing	CCW end points - section 2 phased to section 1 within ± 2°		
Taps	Center tap only		

MARKING	
Unit Identification	Manufacturer's name and model number, resistance value and tolerance, linearity specification date code and terminal identification

RESISTANCE VALUES	
Ohms	
533:	50R, 100R, 200R, 500R, 1K, 2K, 5K, 10K, 20K
534:	100R, 200R, 500R, 1K, 2K, 5K, 10K, 20K, 50K, 100K
535:	50R, 100R, 200R, 500R, 1K, 2K, 5K, 10K, 20K, 50K

ORDERING INFORMATION			
The Models 533 (3 turn), 534 (10 turn) and 535 (5 turn) can be ordered by stating			
534	1	2	XXX
MODEL	MOUNTING	NUMBER OF SECTIONS	RESISTANCE EIA CODE
	1. Bushing 2. Servo	1. Single section 2. Dual section	

Model 533, 534, 535

Vishay Spectrol

7/8" (22mm) Precision
Wirewound Potentiometer



SINGLE SECTION DIMENSIONS in millimeters

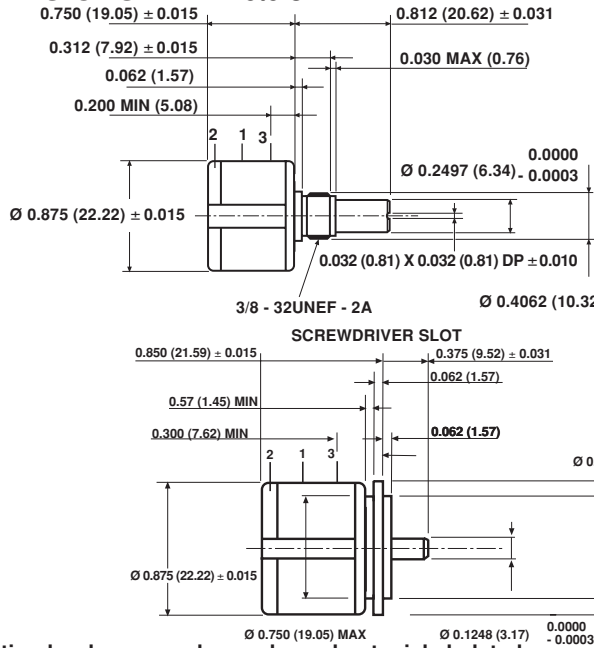

METRIC

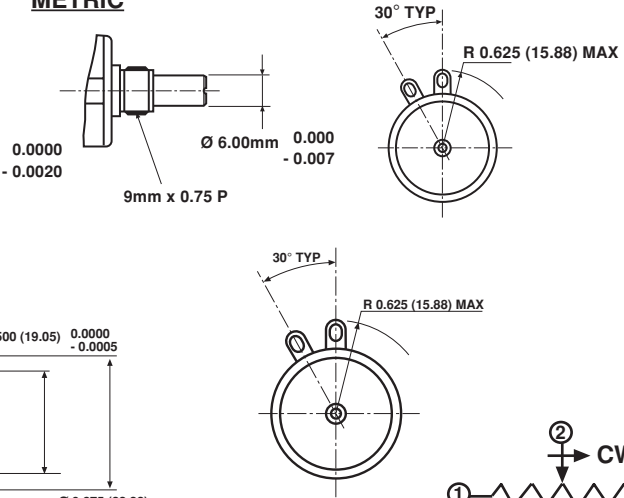

Mounting hardware, washer and panel nut, nickel plated

MECHANICAL SPECIFICATIONS

PARAMETER		
Bearing Type	Bushing: Sleeve bearing Servo: Ball	
Torque (maximums): starting	534	533/535
Section 1	0.5 oz - in (36gm - cms)	0.7 oz - in (50gm - cms)
Section 2	0.9 oz - in (65gm - cms)	1.1 oz - in (79gm - cms)
Torque (maximums): running	534	533/535
Section 1	0.4 oz - in (28.80gm - cms)	0.6 oz - in (43.20gm - cms)
Section 2	0.7 oz - in (50.40gm - cms)	0.9 oz - in (64.8gm - cms)
Weight (maximums)	0.75 oz (21.26gm)	
Section 1	1.25 oz (35.44gm)	
Section 2		
Stop Strength	75 oz - in (static) (5.4Kg - cm)	
Ganging	2 sections maximum	

POWER RATING CHART

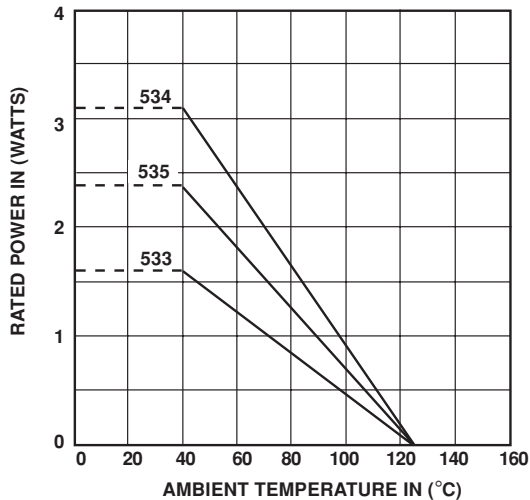

ENVIRONMENTAL SPECIFICATIONS

Vibration	15g thru 2000Hz
Shock	50g
Rotational Life (Shaft Revolution)	
533	300,000
534	1,000,000
534 (Servo)	> 1,000,000
535	500,000
Load Life	900 Hours
Temperature Range	- 55°C to + 125°C



RESISTANCE ELEMENT DATA														
RESISTANCE VALUE (Ω)			RESOLUTION %			OHMS PER TURN			MAX CURRENT AT 70°C AMBIENT (mA)			MAX VOLTAGE ACROSS COIL (V)		
533	534	535	533	534	535	533	534	535	533	534	535	533	534	535
50	–	50	0.149	–	0.120	0.0746	–	0.0603	141.0	–	173.0	7.07	–	8.66
100	100	100	0.111	0.060	0.075	0.1114	0.0603	0.0746	100.0	141.0	122.0	10.0	14.1	12.2
200	200	200	0.097	0.037	0.061	0.1954	0.0746	0.1220	70.7	100.0	86.6	14.1	20.0	17.3
500	500	500	0.069	0.031	0.049	0.3424	0.1520	0.2459	44.7	63.2	54.7	22.4	31.6	27.4
1K	1K	1K	0.063	0.025	0.041	0.6331	0.2459	0.4113	31.6	44.7	38.7	31.6	44.7	38.7
2K	2K	2K	0.041	0.021	0.031	0.8206	0.4113	0.6331	22.4	31.6	27.4	44.7	63.2	54.8
5K	5K	5K	0.044	0.016	0.034	2.2330	0.8206	1.7230	14.1	20.0	17.3	70.7	100.0	86.6
10K	10K	10K	0.034	0.017	0.030	3.4510	1.7230	3.0160	10.0	14.1	12.2	100.0	141.0	122.0
20K	20K	20K	0.031	0.015	0.020	6.1790	3.0160	3.9910	7.07	10.0	8.66	141.0	200.0	173.0
–	50K	50K	–	0.009	0.015	–	4.6690	7.4560	–	6.32	5.47	–	316.0	274.0
–	100K	–	–	0.007	–	–	7.4560	–	–	4.47	–	–	447.0	–
–	–	–	–	–	–	–	–	–	–	–	–	–	–	–
–	–	–	–	–	–	–	–	–	–	–	–	–	–	–