



ILD205T/206T/207T/211T/213T/217T

Dual Phototransistor

Small Outline Surface Mount Optocoupler

FEATURES

- **Two Channel Coupler**
- **SOIC-8A Surface Mountable Package**
- **Standard Lead Spacing of .05"**
- **Available only on Tape and Reel Option (Conforms to EIA Standard 481-2)**
- **Isolation Test Voltage, 3000 V_{RMS}**
- **High Current Transfer Ratios**
ILD205T, 40 – 80%
ILD206T, 63 –125%
ILD207T, 100 – 200%
ILD211T, 20% Minimum
ILD213T, 100% Minimum
ILD217T, 100% Minimum at 1.0 mA
- **High BV_{CEO}, 70 V**
- **Compatible with Dual Wave, Vapor Phase and IR Reflow Soldering**
- **Underwriters Laboratory File #E52744 (Code Letter Y)**

DESCRIPTION

The ILD205T/206T/207T/211T/213T/217T are optically coupled pairs with a Gallium Arsenide infrared LED and a silicon NPN phototransistor. Signal information, including a DC level, can be transmitted by the device while maintaining a high degree of electrical isolation between input and output. The ILD205T/6T/7T/11T/13T/17T come in a standard SOIC-8A small outline package for surface mounting which makes it ideally suited for high density applications with limited space. In addition to eliminating through-holes requirements, this package conforms to standards for surface mounted devices. A specified minimum and maximum CTR allows a narrow tolerance in the electrical design of the adjacent circuits. The high BV_{CEO} of 70 volts gives a higher safety margin compared to the industry standard of 30 volts.

Maximum Ratings (Each Channel)

Emitter

Peak Reverse Voltage 6.0 V
 Peak Pulsed Current (1.0 μs, 300 pps) 1.0 A
 Continuous Forward Current per Channel 30 mA
 Power Dissipation at 25°C 50 mW
 Derate Linearly from 25°C 0.66 mW/°C

Detector

Collector-Emitter Breakdown Voltage 70 V
 Emitter-Collector Breakdown Voltage 7.0 V
 Power Dissipation per Channel 125 mW
 Derate Linearly from 25°C 1.67 mW/°C

Package

Total Package Dissipation at 25°C Ambient
 (2 LEDs + 2 Detectors, 2 Channels) 300 mW
 Derate Linearly from 25°C 4.0 mW/°C
 Storage Temperature -55°C to +150°C
 Operating Temperature -55°C to +100°C
 Soldering Time at 260°C 10 sec.

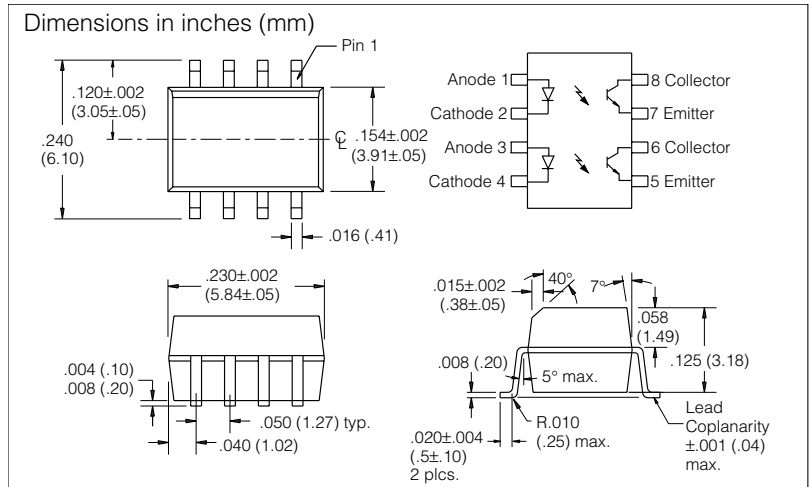

Table 1. Characteristics T_A=25°C

Parameter	Min.	Typ.	Max.	Unit	Condition	
Emitter						
Forward Voltage	—	1.2	1.55	V	I _F =10 mA	
Reverse Current	—	0.1	100	μA	V _R =6.0 V	
Capacitance	—	25	—	pF	V _R =0	
Detector						
Breakdown Voltage	BV _{CEO}	70	—	V	I _C =10 μA	
	BV _{ECO}	7.0	—	V	I _E =10 μA	
	I _{CEO}	—	5.0	50	nA	V _{CE} =10 V I _F =0
Collector-Emitter Capacitance	—	10	—	pF	V _{CE} =0	
Package						
DC Current Transfer, V _{CE} =5.0 V	ILD205	40	—	80	%	I _F =10 mA
	ILD206	63	—	125		
	ILD207	100	—	200		
	ILD211	20	—	—		
	ILD213	100	—	—		I _F =1.0 mA
	ILD205	13	30	—		
	ILD206	22	45	—		
Collector-Emitter Saturation Voltage V _{CE(sat)}	—	—	0.4	V	I _F =10 mA I _C =2.5 mA	
Capacitance, Input to Output	—	0.5	—	pF	—	
Isolation Test Voltage	3000	—	—	V _{RMS}	t=1.0 sec.	
Resistance, Input to Output	—	100	—	GΩ	—	
Turn-on Time	—	5.0	—	μs	I _C =2.0 mA R _L = 100 Ω V _{CC} =5.0 V	
Turn-off Time	—	4.0	—	μs		

Figure 1. Forward current versus forward voltage

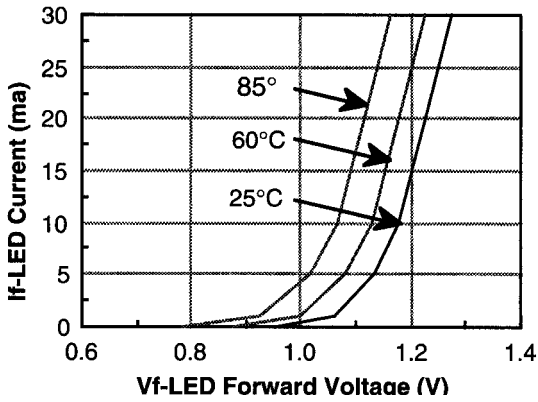

Figure 5. Switching speed versus load resistor

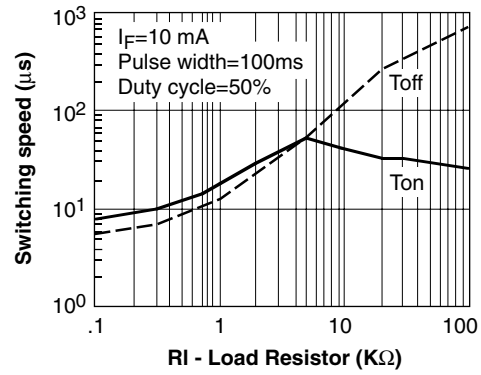

Figure 2. Collector-emitter current versus temperature

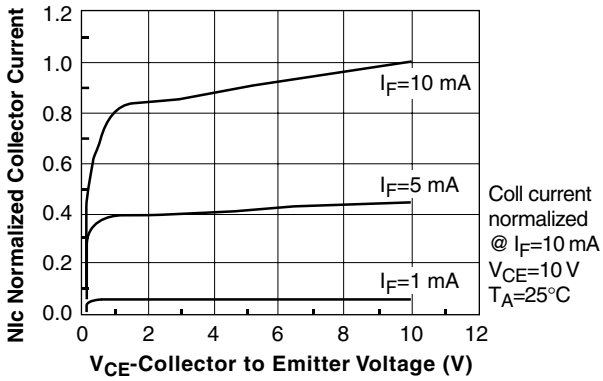

Figure 6. Collector current versus temperature

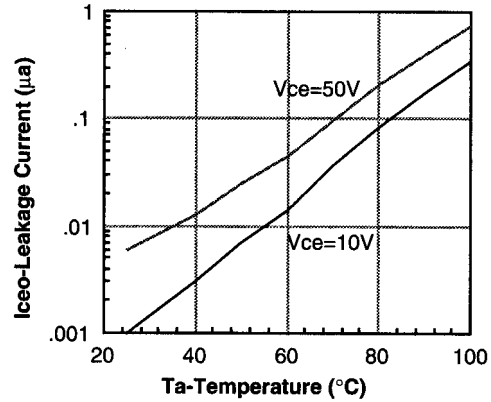

Figure 3. Normalized CTR_{ce} versus forward current

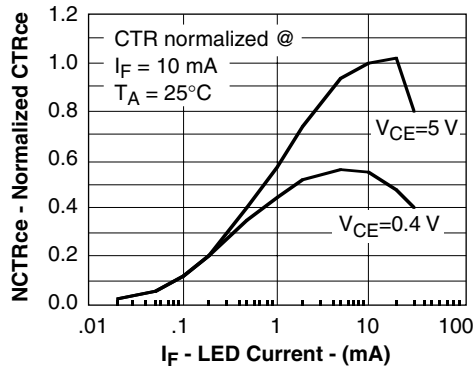

Figure 7. Power dissipation versus ambient temperature

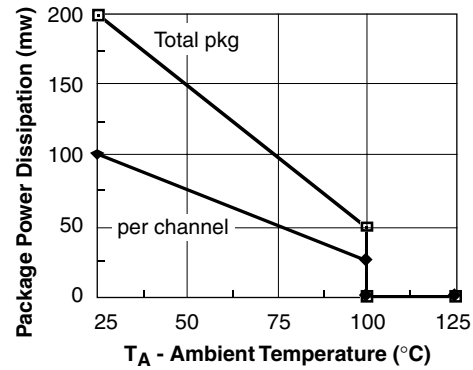

Figure 4. CTR (normalized) versus temperature

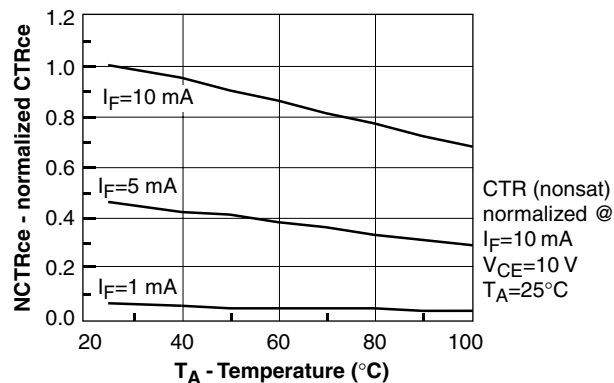

Figure 8. Switching time test schematic and waveform

