

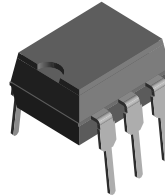

Zero Voltage Crossing Triac Optocoupler (600 V/ 700 V/ 800 V)

Features

- High Input Sensitivity: $I_{FT} = 1.3 \text{ mA}$, $PF = 1.0$;
 $I_{FT} = 3.5 \text{ mA}$, Typical $PF < 1.0$
- Zero Voltage Crossing
- 600/700/800 V Blocking Voltage
- 300 mA On-State Current
- High dV/dt 10,000 V/ μsec .
- Inverse Parallel SCRs Provide Commutating $dV/dt > 10 \text{ kV}/\mu\text{s}$
- Isolation Test Voltage 5300 V_{RMS}
- Very Low Leakage $< 10 \mu\text{A}$



18099

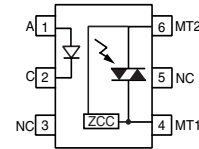

Agency Approvals

- UL - File No. E52744 System Code H or J
- CSA Cert. 93751
- BABS/BSI
- DIN EN 60747-5-5 (VDE 0884):2003-01 Available with Option 1
- FIMKO EN60950

Applications

- Solid state relays
- Lighting controls
- Temperature controls
- Solenoid/valve controls
- AC motor drives/starters

Description

The IL4116/ IL4117/ IL4118 consists of an AlGaAs IRLED optically coupled to a photosensitive zero crossing TRIAC network. The TRIAC consists of two inverse parallel connected monolithic SCRs. These three semi-conductor devices are assembled in a six pin 300 mil dual in-line package.

High input sensitivity is achieved by using an emitter follower phototransistor and a cascaded SCR pre-driver resulting in an LED trigger current of less than 1.3 mA(DC).

The IL4116/ IL4117/ IL4118 uses zero cross line voltage detection circuit which consists of two enhancement MOSFETS and a photodiode. The inhibit voltage of the network is determined by the enhancement voltage of the N-channel FET. The P-channel FET is enabled by a photocurrent source that permits the FET to conduct the main voltage to gate on the N-channel FET. Once the main voltage can enable the N-channel, it clamps the base of the phototransistor, disabling the first stage SCR predriver.

The blocking voltage of up to 800 V permits control of off-line voltages up to 240 VAC, with a safety factor of more than two, and is sufficient for as much as 380 VAC. Current handling capability is up to 300 mA RMS continuous at 25 °C.

The IL4116/ IL4117/ IL4118 isolates low-voltage logic from 120, 240, and 380 VAC lines to control resistive, inductive, or capacitive loads including motors, solenoids, high current thyristors or TRIAC and relays.

Applications include solid-state relays, industrial controls, office equipment, and consumer appliances.

Order Information

Part	Remarks
IL4116	600 V V_{DRM} , 6 pin DIP
IL4117	700 V V_{DRM} , 6 pin DIP
IL4118	800 V V_{DRM} , 6 pin DIP

For additional order information see Option Section

Absolute Maximum Ratings

$T_{amb} = 25\text{ }^{\circ}\text{C}$, unless otherwise specified

Stresses in excess of the absolute Maximum Ratings can cause permanent damage to the device. Functional operation of the device is not implied at these or any other conditions in excess of those given in the operational sections of this document. Exposure to absolute Maximum Rating for extended periods of the time can adversely affect reliability.

Input

Parameter	Test condition	Symbol	Value	Unit
Reverse voltage		V_R	6.0	V
Forward current		I_F	60	mA
Surge current		I_{FSM}	2.5	A
Power dissipation		P_{diss}	100	mW
Derate linearly from 25 °C			1.33	mW/°C
Thermal resistance		R_{th}	750	°C/W

Output

Parameter	Test condition	Part	Symbol	Value	Unit
Peak off-state voltage		IL4116	V_{DRM}	600	V
		IL4117	V_{DRM}	700	V
		IL4118	V_{DRM}	800	V
RMS on-state current			I_{DRM}	300	mA
Single cycle surge				3.0	A
Power dissipation			P_{diss}	500	mW
Derate linearly from 25 °C				6.6	mW/°C
Thermal resistance			R_{th}	150	°C/W

Coupler

Parameter	Test condition	Symbol	Value	Unit
Lead soldering temperature	5 sec.	T_{sld}	260	°C
Creepage distance			≥ 7.0	mm
Clearance			≥ 7.0	mm
Storage temperature		T_{stg}	- 55 to + 150	°C
Operating temperature		T_{op}	- 55 to + 100	°C
Isolation test voltage		V_{IO}	5300	V_{RMS}
Isolation resistance	$V_{IO} = 500\text{ V}, T_{amb} = 25\text{ }^{\circ}\text{C}$	R_{IO}	$\geq 10^{12}$	Ω
	$V_{IO} = 500\text{ V}, T_{amb} = 100\text{ }^{\circ}\text{C}$	R_{IO}	$\geq 10^{11}$	Ω



Electrical Characteristics

T_{amb} = 25 °C, unless otherwise specified

Minimum and maximum values are testing requirements. Typical values are characteristics of the device and are the result of engineering evaluation. Typical values are for information only and are not part of the testing requirements.

Input

T_{amb}=25°C

Parameter	Test condition	Symbol	Min	Typ.	Max	Unit
Forward voltage	I _F = 20 mA	V _F		1.3	1.5	V
Breakdown voltage	I _R = 10 μA	V _{BR}	6.0	30		V
Reverse current	V _R = 6.0 V	I _R		0.1	10	μA
Capacitance	V _F = 0 V, f = 1.0 MHz	C _O		40		pF
Thermal resistance, junction to lead		R _{thjl}		750		°C/W

Output

Parameter	Test condition	Part	Symbol	Min	Typ.	Max	Unit
Repetitive peak off-state voltage	I _{DRM} = 100 μA	IL4116	V _{DRM}	600	650		V
		IL4117	V _{DRM}	700	750		V
		IL4118	V _{DRM}	800	850		V
Off-state voltage	I _{D(RMS)} = 70 μA	IL4116	V _{D(RMS)}	424	460		V
		IL4117	V _{D(RMS)}	494	536		V
		IL4118	V _{D(RMS)}	565	613		V
Off-state current	V _D = 600, T _{amb} = 100 °C		I _{D(RMS)}		10	100	μA
On-state voltage	I _T = 300 mA		V _{TM}		1.7	3.0	V
On-state current	PF = 1.0, V _{T(RMS)} = 1.7 V		I _{TM}			300	mA
Surge (non-repetitive, on-state current)	f = 50 Hz		I _{TSM}			3.0	A
Holding current	V _T = 3.0 V		I _H		65	200	μA
Latching current	V _T = 2.2 V		I _L		5.0		mA
LED trigger current	V _{AK} = 5.0 V		I _{FT}		0.7	1.3	mA
Zero cross inhibit voltage	I _F = Rated I _{FT}		V _{IH}		15	25	V
Critical state of rise: off-state voltage	V _{RM} , V _{DM} = 400 VAC		dV _{(MT)/dt}	10,000			V/μs
	V _{RM} , V _{DM} = 400 VAC, T _{amb} = 80 °C		dV _{(MT)/dt}		2000		V/μs
Commutating voltage	V _{RM} , V _{DM} = 400 VAC		dV _{(COM)/dt}	10,000			V/μs
	V _{RM} , V _{DM} = 400 VAC, T _{amb} = 80 °C		dV _{(COM)/dt}		2000		V/μs
Commutating current	I _T = 300 mA		di/dt		100		A/ms
Thermal resistance, junction to lead			R _{thjl}		150		°C/W

Coupler

Parameter	Test condition	Symbol	Min	Typ.	Max	Unit
Critical state of rise of coupler input-output voltage	$I_T = 0 \text{ A}$, $V_{RM} = V_{DM} = 424 \text{ VAC}$	$dV_{(IO)}/dt$	10,000			V/ μs
Package capacitance	$f = 1.0 \text{ MHz}$, $V_{IO} = 0 \text{ V}$	C_{IO}		0.8		pF
Common mode coupling capacitor		C_{CM}		0.01		pF

Switching Characteristics

Parameter	Test condition	Symbol	Min	Typ.	Max	Unit
Turn-on time	$V_{RM} = V_{DM} = 424 \text{ VAC}$	t_{on}		35		μs
Turn-off time	$PF = 1.0$, $I_T = 300 \text{ mA}$	t_{off}		50		μs

Typical Characteristics ($T_{amb} = 25^\circ\text{C}$ unless otherwise specified)

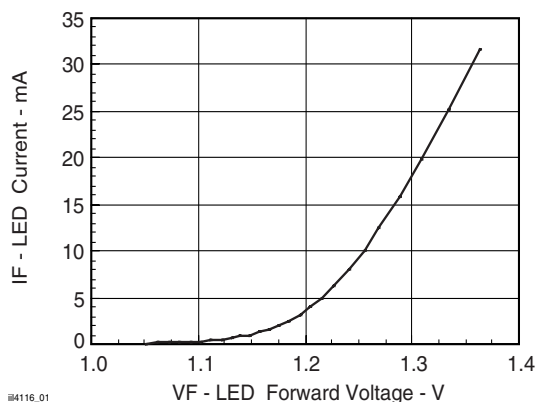

Figure 1. LED Forward Current vs. Forward Voltage

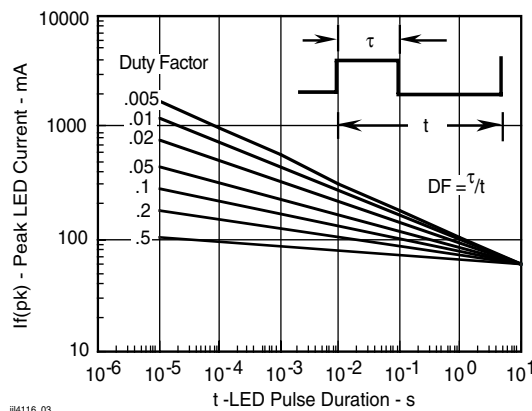

Figure 3. Peak LED Current vs. Duty Factor, Tau

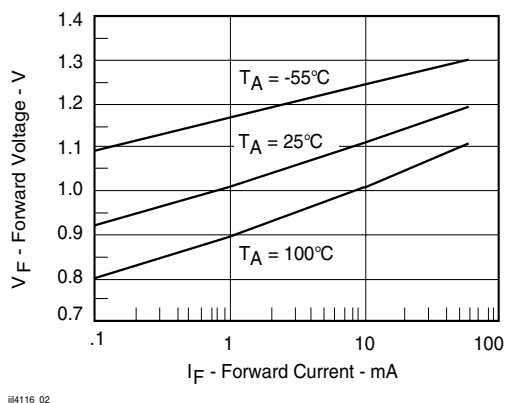

Figure 2. Forward Voltage vs. Forward Current

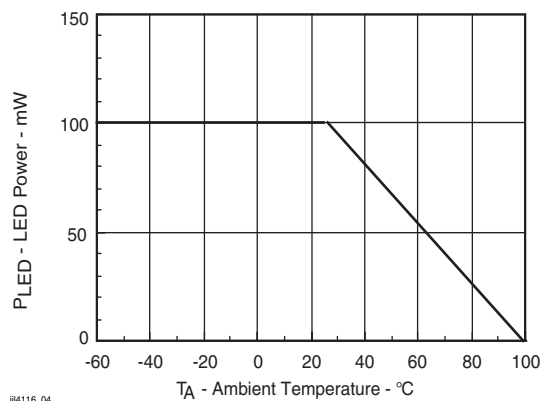
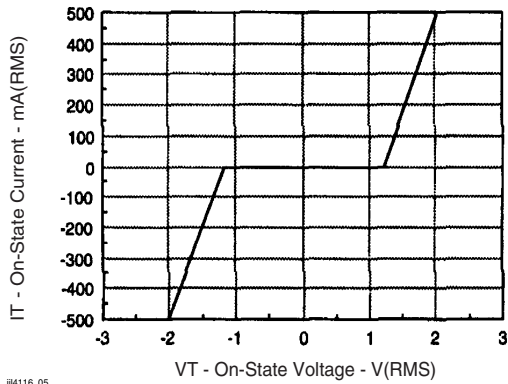
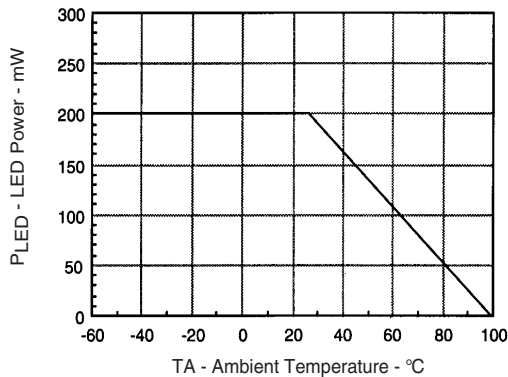

Figure 4. Maximum LED Power Dissipation



IL4116_05

Figure 5. On-State Terminal Voltage vs. Terminal Current



IL4116_06

Figure 6. Maximum Output Power Dissipation

Power Factor Considerations

A snubber isn't needed to eliminate false operation of the TRIAC driver because of the IL4116/ IL4117/ IL4118 high static and commutating dV/dt with loads between 1 and 0.8 power factors. When inductive loads with power factors less than 0.8 are being driven, include an RC snubber or a single capacitor directly across the device to damp the peak commutating dV/dt spike. Normally a commutating dV/dt causes a turning-off device to stay on due to the stored energy remaining in the turn-off device.

But in the case of a zero voltage crossing optotriac, the commutating dV/dt spikes can inhibit one half of the TRIAC from turning on. If the spike potential exceeds the inhibit voltage of the zero cross detection circuit, half of the TRIAC will be held-off and not turn-on. This hold-off condition can be eliminated by using a snubber or capacitor placed directly across the

optotriac as shown in Figure 7. Note that the value of the capacitor increases as a function of the load current.

The hold-off condition also can be eliminated by providing a higher level of LED drive current. The higher LED drive provides a larger photocurrent which causes the phototransistor to turn-on before the commutating spike has activated the zero cross network. Figure 8 shows the relationship of the LED drive for power factors of less than 1.0. The curve shows that if a device requires 1.5 mA for a resistive load, then 1.8 times (2.7 mA) that amount would be required to control an inductive load whose power factor is less than 0.3.

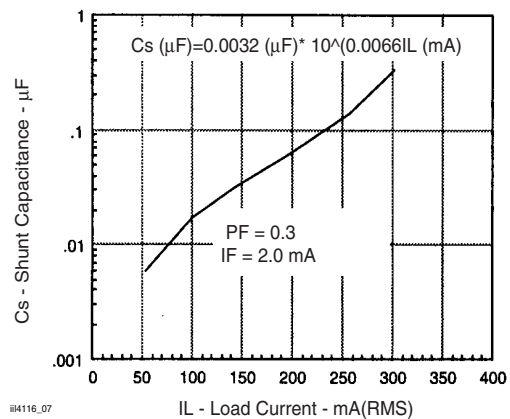

IL4116_07

Figure 7. Shunt Capacitance vs. Load Current vs. Power Factor

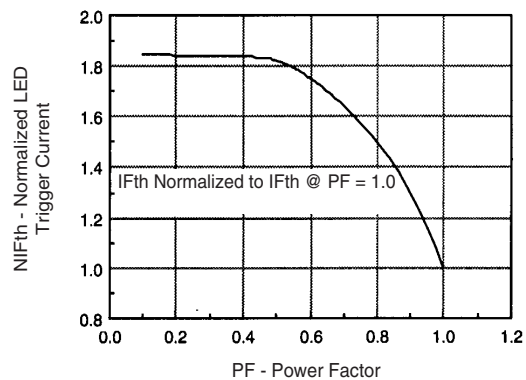

IL4116_08

Figure 8. Normalized LED Trigger Current

IL4116/ IL4117/ IL4118

Vishay Semiconductors

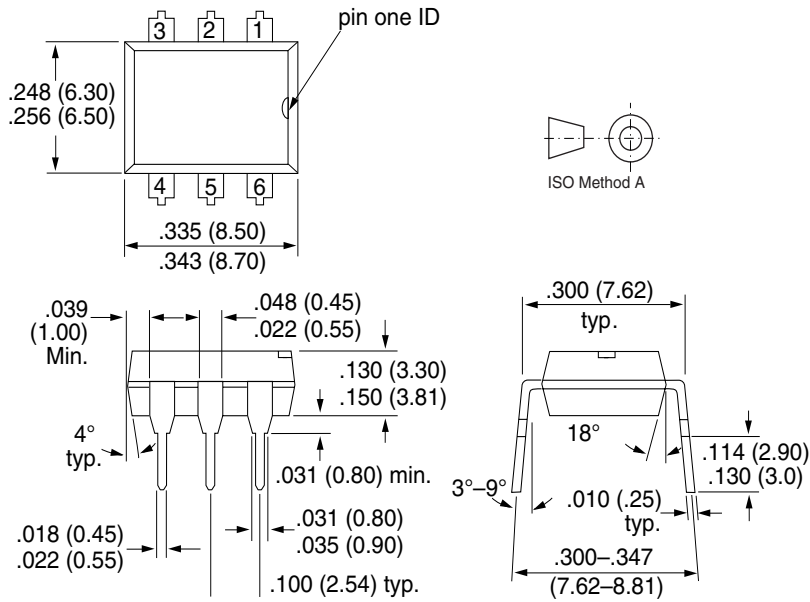

i178004



Ozone Depleting Substances Policy Statement

It is the policy of **Vishay Semiconductor GmbH** to

1. Meet all present and future national and international statutory requirements.
2. Regularly and continuously improve the performance of our products, processes, distribution and operating systems with respect to their impact on the health and safety of our employees and the public, as well as their impact on the environment.

It is particular concern to control or eliminate releases of those substances into the atmosphere which are known as ozone depleting substances (ODSs).

The Montreal Protocol (1987) and its London Amendments (1990) intend to severely restrict the use of ODSs and forbid their use within the next ten years. Various national and international initiatives are pressing for an earlier ban on these substances.

Vishay Semiconductor GmbH has been able to use its policy of continuous improvements to eliminate the use of ODSs listed in the following documents.

1. Annex A, B and list of transitional substances of the Montreal Protocol and the London Amendments respectively
2. Class I and II ozone depleting substances in the Clean Air Act Amendments of 1990 by the Environmental Protection Agency (EPA) in the USA
3. Council Decision 88/540/EEC and 91/690/EEC Annex A, B and C (transitional substances) respectively.

Vishay Semiconductor GmbH can certify that our semiconductors are not manufactured with ozone depleting substances and do not contain such substances.

**We reserve the right to make changes to improve technical design
and may do so without further notice.**

Parameters can vary in different applications. All operating parameters must be validated for each customer application by the customer. Should the buyer use Vishay Semiconductors products for any unintended or unauthorized application, the buyer shall indemnify Vishay Semiconductors against all claims, costs, damages, and expenses, arising out of, directly or indirectly, any claim of personal damage, injury or death associated with such unintended or unauthorized use.

Vishay Semiconductor GmbH, P.O.B. 3535, D-74025 Heilbronn, Germany
Telephone: 49 (0)7131 67 2831, Fax number: 49 (0)7131 67 2423