

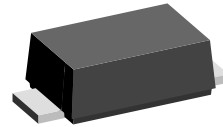

## Voltage Regulator Diodes

### Features

- Silicon Planar Zener Diodes
- Low profile surface-mount package
- Zener and surge current specification
- Low leakage current
- Excellent stability
- High temperature soldering:  
260 °C/10 sec. at terminals



17249

### Mechanical Data

**Case:** JEDEC DO-219AB (SMF<sup>®</sup>) Plastic Case

**Packaging codes/options:**

GS18 - 10 K per 13 " reel, (8 mm tape), 50 K/box  
 GS08 - 3 K per 7 " reel, (8 mm tape), 30 K/box

**Weight:** approx. 10 mg

### Absolute Maximum Ratings

T<sub>amb</sub> = 25 °C, unless otherwise specified

Parameter	Test condition	Symbol	Value	Unit
Power dissipation	T <sub>L</sub> = 80 °C	P <sub>tot</sub>	2.3	W
	T <sub>A</sub> = 25 °C	P <sub>tot</sub>	0.8 <sup>1)</sup>	W
Non-repetitive peak pulse power dissipation	100 μs square pulse <sup>2)</sup>	P <sub>ZSM</sub>	300	W
	10/1000 μs waveform (BZD27-C7V5P to BZD27-C100P) <sup>2)</sup>	P <sub>RSM</sub>	150	W
	10/1000 μs waveform (BZD27-C110P to BZD27-C200P) <sup>2)</sup>	P <sub>RSM</sub>	100	W

<sup>1)</sup> Mounted on epoxy-glass PCB with 3 x 3 mm Cu pads (≥ 40 μm thick)

<sup>2)</sup> T<sub>J</sub> = 25 °C prior to surge

### Thermal Characteristics

T<sub>amb</sub> = 25 °C, unless otherwise specified

Parameter	Test condition	Symbol	Value	Unit
Thermal resistance junction to ambient air <sup>1)</sup>		R <sub>θJA</sub>	180	K/W
Thermal resistance junction to lead		R <sub>θJL</sub>	30	K/W
Maximum junction temperature		T <sub>j</sub>	150	°C
Storage temperature range		T <sub>S</sub>	- 55 to + 150	°C

<sup>1)</sup> Mounted on epoxy-glass PCB with 3 x 3 mm Cu pads (≥ 40 μm thick)

### Electrical Characteristics

T<sub>amb</sub> = 25 °C, unless otherwise specified

Parameter	Test condition	Symbol	Min	Typ.	Max	Unit
Forward voltage	I <sub>F</sub> = 0.2 A	V <sub>F</sub>			1.2	V

# BZD27C3V6P to BZD27C200P



Vishay Semiconductors

## Electrical Characteristics

When used as voltage regulator diodes ( $T_J = 25\text{ }^\circ\text{C}$  unless otherwise noted)

Partnumber	Marking Code	Working Voltage <sup>1)</sup>		Differential Resistance		Temperature Coefficient		Test Current	Reverse Current at Reverse Voltage		
		$V_Z @ I_{ZT}$		$r_{dif} @ I_Z$		$\alpha_Z @ I_Z$			$I_{ZT}$	$I_R$	$V_R$
		V		$\Omega$		%/°C			mA	$\mu\text{A}$	V
		min	max	typ	max	min	max			max	
BZD27C3V6P	D0	3.4	3.8	4	8	-0.14	-0.04	100	100	1	
BZD27C3V9P	D1	3.7	4.1	4	8	-0.14	-0.04	100	50	1	
BZD27C4V3P	D2	4	4.6	4	7	-0.12	-0.02	100	25	1	
BZD27C4V7P	D3	4.4	5	3	7	-0.1	0	100	10	1	
BZD27C5V1P	D4	4.8	5.4	3	6	-0.08	0.02	100	5	1	
BZD27C5V6P	D5	5.2	6	2	4	-0.04	0.04	100	10	2	
BZD27C6V2P	D6	5.8	6.6	2	3	-0.01	0.06	100	5	2	
BZD27C6V8P	D7	6.4	7.2	1	3	0	0.07	100	10	3	
BZD27C7V5P	D8	7	7.9	1	2	0	0.07	100	50	3	
BZD27C8V2P	D9	7.7	8.7	1	2	0.03	0.08	100	10	3	
BZD27C9V1P	E0	8.5	9.6	2	4	0.03	0.08	50	10	5	
BZD27C10P	E1	9.4	10.6	2	4	0.05	0.09	50	7	7.5	
BZD27C11P	E2	10.4	11.6	4	7	0.05	0.1	50	4	8.2	
BZD27C12P	E3	11.4	12.7	4	7	0.05	0.1	50	3	9.1	
BZD27C13P	E4	12.4	14.1	5	10	0.05	0.1	50	2	10	
BZD27C15P	E5	13.8	15.6	5	10	0.05	0.1	50	1	11	
BZD27C16P	E6	15.3	17.1	6	15	0.06	0.11	25	1	12	
BZD27C18P	E7	16.8	19.1	6	15	0.06	0.11	25	1	13	
BZD27C20P	E8	18.8	21.2	6	15	0.06	0.11	25	1	15	
BZD27C22P	E9	20.8	23.3	6	15	0.06	0.11	25	1	16	
BZD27C24P	F0	22.8	25.6	7	15	0.06	0.11	25	1	18	
BZD27C27P	F1	25.1	28.9	7	15	0.06	0.11	25	1	20	
BZD27C30P	F2	28	32	8	15	0.06	0.11	25	1	22	
BZD27C33P	F3	31	35	8	15	0.06	0.11	25	1	24	
BZD27C36P	F4	34	38	21	40	0.06	0.11	10	1	27	
BZD27C39P	F5	37	41	21	40	0.06	0.11	10	1	30	
BZD27C43P	F6	40	46	24	45	0.07	0.12	10	1	33	
BZD27C47P	F7	44	50	24	45	0.07	0.12	10	1	36	
BZD27C51P	F8	48	54	25	60	0.07	0.12	10	1	39	
BZD27C56P	F9	52	60	25	60	0.07	0.12	10	1	43	
BZD27C62P	G0	58	66	25	80	0.08	0.13	10	1	47	
BZD27C68P	G1	64	72	25	80	0.08	0.13	10	1	51	
BZD27C75P	G2	70	79	30	100	0.08	0.13	10	1	56	
BZD27C82P	G3	77	87	30	100	0.08	0.13	10	1	62	
BZD27C91P	G4	85	96	60	200	0.08	0.13	5	1	68	
BZD27C100P	G5	94	106	60	200	0.09	0.13	5	1	75	
BZD27C110P	G6	104	116	80	250	0.09	0.13	5	1	82	
BZD27C120P	G7	114	127	80	250	0.09	0.13	5	1	91	
BZD27C130P	G8	124	141	110	300	0.09	0.13	5	1	100	
BZD27C150P	G9	138	156	130	300	0.09	0.13	5	1	110	
BZD27C160P	H0	153	171	150	350	0.09	0.13	5	1	120	
BZD27C180P	H1	168	191	180	400	0.09	0.13	5	1	130	
BZD27C200P	H2	188	212	200	500	0.09	0.13	5	1	150	

<sup>1)</sup> Pulse test:  $t_p \leq 5\text{ ms}$ .



# BZD27C3V6P to BZD27C200P

Vishay Semiconductors

## Electrical Characteristics

When used as protection diodes ( $T_J = 25\text{ }^\circ\text{C}$  unless otherwise noted)

Partnumber	Rev. Breakdown Voltage	Test Current	Temperature Coefficient		Clamping Voltage		Reverse Current at Stand-Off Voltage	
			$\alpha_Z$ @ $I_{test}$		$V_C$	at $I_{RSM}^{1)}$	$I_R$	at $V_{WM}$
	$V_{(BR)R}$ at $I_{test}$	$I_{test}$	$\% / ^\circ\text{C}$		V	A	$\mu\text{A}$	V
	V	mA	min	max	max		max	
BZD27C7V5P	7	100	0	0.07	11.3	13.3	1500	6.2
BZD27C8V2P	7.7	100	0.03	0.08	12.3	12.2	1200	6.8
BZD27C9V1P	8.5	50	0.03	0.08	13.3	11.3	100	7.5
BZD27C10P	9.4	50	0.05	0.09	14.8	10.1	20	8.2
BZD27C11P	10.4	50	0.05	0.1	15.7	9.6	5	9.1
BZD27C12P	11.4	50	0.05	0.1	17	8.8	5	10
BZD27C13P	12.4	50	0.05	0.1	18.9	7.9	5	11
BZD27C15P	13.8	50	0.05	0.1	20.9	7.2	5	12
BZD27C16P	15.3	25	0.06	0.11	22.9	6.6	5	13
BZD27C18P	16.8	25	0.06	0.11	25.6	5.9	5	15
BZD27C20P	18.8	25	0.06	0.11	28.4	5.3	5	16
BZD27C22P	20.8	25	0.06	0.11	31	4.8	5	18
BZD27C24P	22.8	25	0.06	0.11	33.8	4.4	5	20
BZD27C27P	25.1	25	0.06	0.11	38.1	3.9	5	22
BZD27C30P	28	25	0.06	0.11	42.2	3.6	5	24
BZD27C33P	31	25	0.06	0.11	46.2	3.2	5	27
BZD27C36P	34	10	0.06	0.11	50.1	3	5	30
BZD27C39P	37	10	0.06	0.11	54.1	2.8	5	33
BZD27C43P	40	10	0.07	0.12	60.7	2.5	5	36
BZD27C47P	44	10	0.07	0.12	65.5	2.3	5	39
BZD27C51P	48	10	0.07	0.12	70.8	2.1	5	43
BZD27C56P	52	10	0.07	0.12	78.6	1.9	5	47
BZD27C62P	58	10	0.08	0.13	86.5	1.7	5	51
BZD27C68P	64	10	0.08	0.13	94.4	1.6	5	56
BZD27C75P	70	10	0.08	0.13	103.5	1.5	5	62
BZD27C82P	77	10	0.08	0.13	114	1.3	5	68
BZD27C91P	85	5	0.09	0.13	126	1.2	5	75
BZD27C100P	94	5	0.09	0.13	139	1.1	5	82
BZD27C110P	104	5	0.09	0.13	139	0.72	5	91
BZD27C120P	114	5	0.09	0.13	152	0.65	5	100
BZD27C130P	124	5	0.09	0.13	169	0.59	5	110
BZD27C150P	138	5	0.09	0.13	187	0.53	5	120
BZD27C160P	153	5	0.09	0.13	205	0.48	5	130
BZD27C180P	168	5	0.09	0.13	229	0.43	5	150
BZD27C200P	188	5	0.09	0.13	254	0.39	5	160

<sup>1)</sup> Non-repetitive peak reverse current in accordance with "IEC 60-1, Section 8" (10/1000  $\mu\text{s}$  pulse); see Fig. 5.

# BZD27C3V6P to BZD27C200P



Vishay Semiconductors

## Typical Characteristics ( $T_{amb} = 25\text{ }^{\circ}\text{C}$ unless otherwise specified)

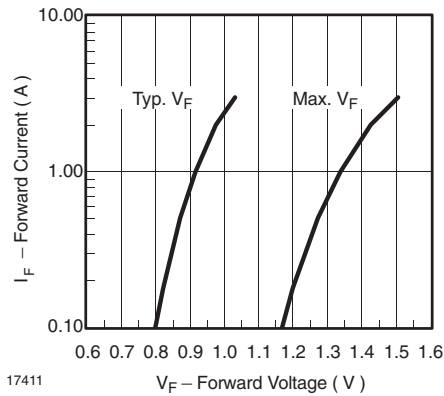

Figure 1. Forward Current vs. Forward Voltage

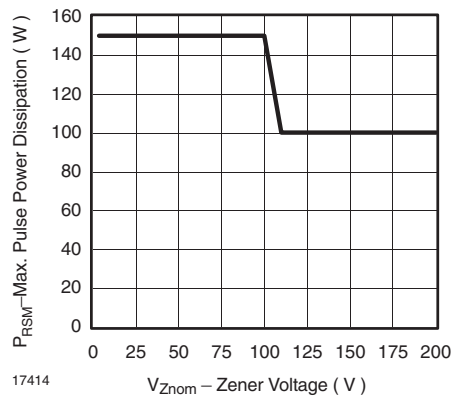

Figure 4. Maximum Pulse Power Dissipation vs. Zener Voltage

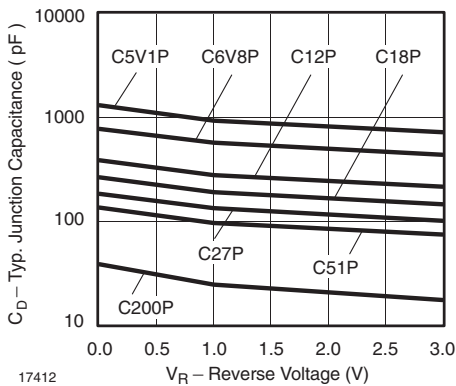

Figure 2. Typ. Diode Capacitance vs. Reverse Voltage

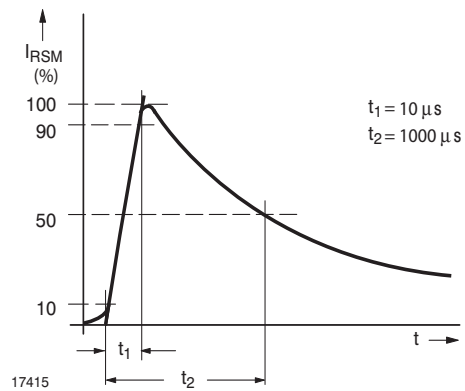

Figure 5. Non-Repetitive Peak Reverse Current Pulse Definition

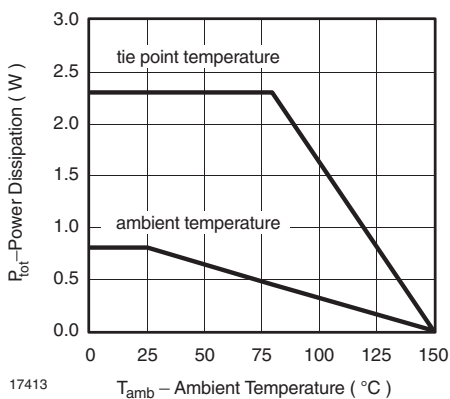

Figure 3. Power Dissipation vs. Ambient Temperature



# BZD27C3V6P to BZD27C200P

Vishay Semiconductors

## Package Dimensions in mm

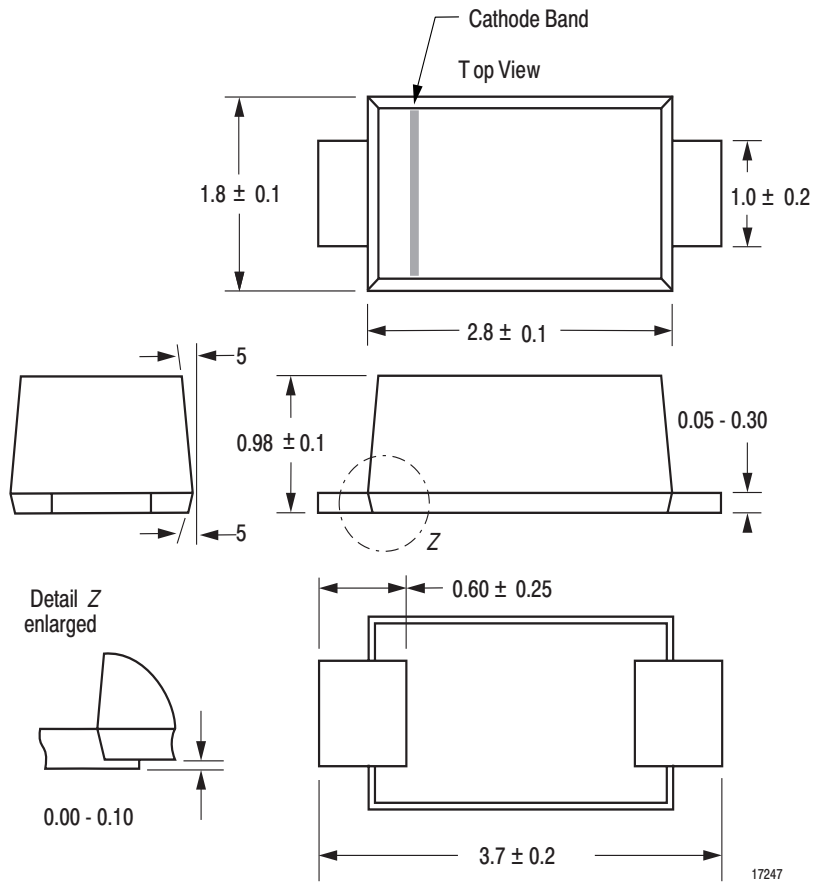

## Mounting Pad Layout

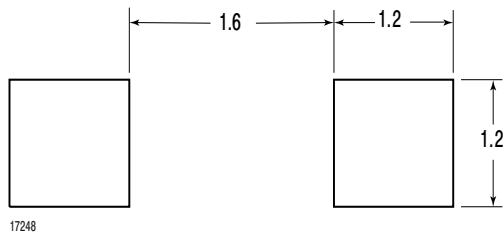

## Ozone Depleting Substances Policy Statement

It is the policy of **Vishay Semiconductor GmbH** to

1. Meet all present and future national and international statutory requirements.
2. Regularly and continuously improve the performance of our products, processes, distribution and operating systems with respect to their impact on the health and safety of our employees and the public, as well as their impact on the environment.

It is particular concern to control or eliminate releases of those substances into the atmosphere which are known as ozone depleting substances (ODSs).

The Montreal Protocol (1987) and its London Amendments (1990) intend to severely restrict the use of ODSs and forbid their use within the next ten years. Various national and international initiatives are pressing for an earlier ban on these substances.

**Vishay Semiconductor GmbH** has been able to use its policy of continuous improvements to eliminate the use of ODSs listed in the following documents.

1. Annex A, B and list of transitional substances of the Montreal Protocol and the London Amendments respectively
2. Class I and II ozone depleting substances in the Clean Air Act Amendments of 1990 by the Environmental Protection Agency (EPA) in the USA
3. Council Decision 88/540/EEC and 91/690/EEC Annex A, B and C (transitional substances) respectively.

**Vishay Semiconductor GmbH** can certify that our semiconductors are not manufactured with ozone depleting substances and do not contain such substances.

**We reserve the right to make changes to improve technical design  
and may do so without further notice.**

Parameters can vary in different applications. All operating parameters must be validated for each customer application by the customer. Should the buyer use Vishay Semiconductors products for any unintended or unauthorized application, the buyer shall indemnify Vishay Semiconductors against all claims, costs, damages, and expenses, arising out of, directly or indirectly, any claim of personal damage, injury or death associated with such unintended or unauthorized use.

Vishay Semiconductor GmbH, P.O.B. 3535, D-74025 Heilbronn, Germany  
Telephone: 49 (0)7131 67 2831, Fax number: 49 (0)7131 67 2423