



### ABSOLUTE MAXIMUM RATINGS

Supply Voltage VCC	Internally Limited
VCC Supply Clamp Current	20mA
PFC Gate Driver Current (continuous)	± 0.5A
PFC Gate Driver Current (peak)	± 1.5A
ZVT Drive Current (continuous)	± 0.25A
ZVT Drive Current (peak)	± 0.75A
Input Current (IAC, RT, RVA)	5mA
Analog Inputs (except Peak Limit)	-0.3 to 10V
Peak Limit Input	-0.3 to 6.5V
Softstart Sinking Current	1.5mA
Storage Temperature	-65°C to +150°C
Junction Temperature	-55°C to +150°C
Lead Temperature (Soldering, 10 sec.)	+300°C

Currents are positive into, negative out of the specified terminal. Consult Packaging Section of Databook for thermal limitations and considerations of packages. All voltages are referenced to GND.

### CONNECTION DIAGRAMS

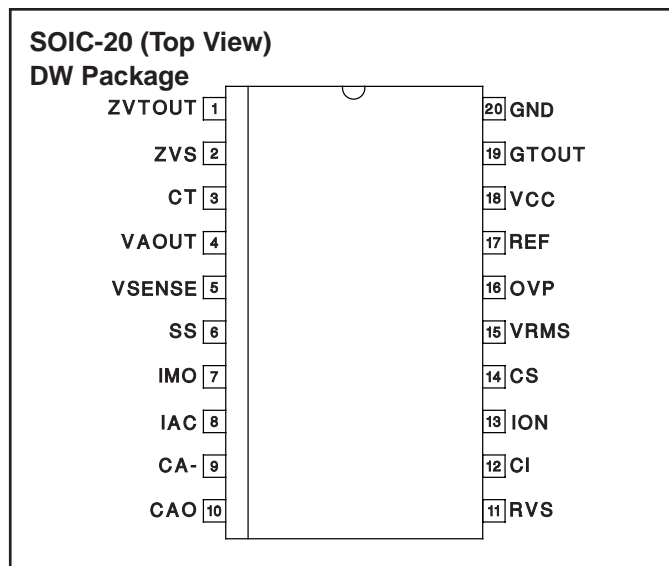
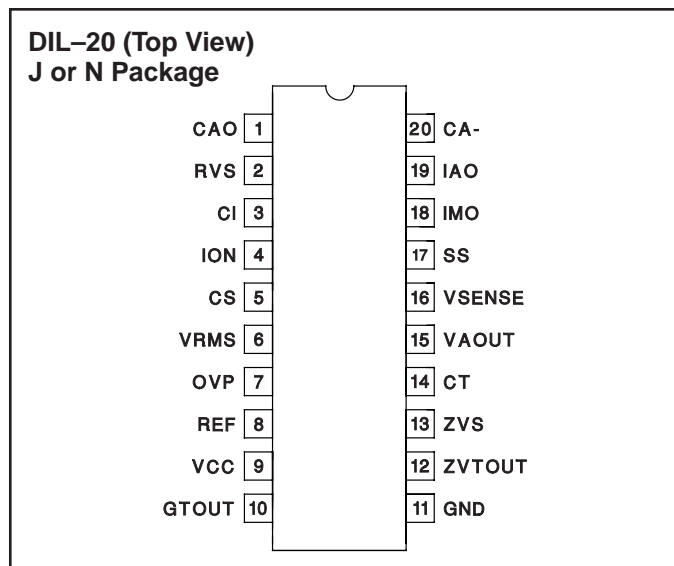
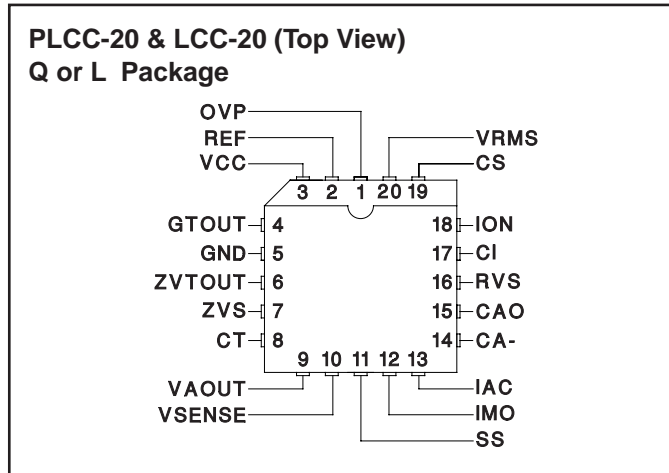

**ELECTRICAL CHARACTERISTICS:** Unless otherwise specified: VCC = 18V, RT = 15k, RVS = 23k, CT = 470pF, CI = 150pF, VRMS = 1.5V, IAC = 100µA, ISENSE = 0V, CAOUT = 4V, VAOUT = 3.5V, VSENSE = 3V. -40°C to 85°C (UC2855A/B), 0°C to 70°C (UC3855A/B).

PARAMETER	TEST CONDITIONS	MIN	TYP	MAX	UNITS
<b>Overall</b>					
Supply Current, OFF	CAO, VAOUT = 0V, VCC = UVLO -0.3V		150	500	µA
Supply Current, OPERATING			17	25	mA
VCC Turn-On Threshold	UC3855A		15.5	17.5	V
VCCTurn-Off Threshold	UC3855A,B	9	10		V
VCC Turn-On Threshold	UC3855B		10.5	10.8	V
VCC Clamp	I(VCC) = ICC(on) + 5mA	18	20	22	V
<b>Voltage Amplifier</b>					
Input Voltage		2.9		3.1	V
VSENSE Bias Current		-500	25	500	nA
Open Loop Gain	VOUT = 2 to 5V	65	80		dB
VOUT High	ILOAD = -300µA	5.75	6	6.25	V
VOUT Low	ILOAD = 300µA		0.3	0.5	V
Output Short Circuit Current	VOUT = 0V		0.6	3	mA

**ELECTRICAL CHARACTERISTICS:** Unless otherwise specified:  $V_{CC} = 18V$ ,  $R_T = 15k$ ,  $R_{VS} = 23k$ ,  $C_T = 470pF$ ,  $C_I = 150pF$ ,  $V_{RMS} = 1.5V$ ,  $I_{AC} = 100\mu A$ ,  $I_{SENSE} = 0V$ ,  $C_{AOUT} = 4V$ ,  $V_{AOUT} = 3.5V$ ,  $V_{SENSE} = 3V$ .  $-40^{\circ}C$  to  $85^{\circ}C$  (UC2855A/B),  $0^{\circ}C$  to  $70^{\circ}C$  (UC3855A/B).

PARAMETER	TEST CONDITIONS	MIN	TYP	MAX	UNITS
<b>Current Amplifier</b>					
Input Offset Voltage	$V_{CM} = -2.5V$	-4		4	mV
Input Bias Current (Sense)	$V_{CM} = 2.5V$	-500		500	nA
Open Loop Gain	$V_{CM} = 2.5V$ , $V_{OUT} = 2$ to $6V$	80	110		dB
$V_{OUT}$ High	$I_{LOAD} = -500\mu A$		6		V
$V_{OUT}$ Low	$I_{LOAD} = 500\mu A$		0.3	0.5	V
Output Short Circuit Current	$V_{OUT} = 0V$		1	3	mA
Common Mode Range		-0.3		5	V
Gain Bandwidth Product	$F_{IN} = 100kHz$ , $10mV$ , P-P, $T_A = 25^{\circ}C$	2.5	5		MHz
<b>Reference</b>					
Output Voltage	$I_{REF} = 0mA$ , $T_A = 25^{\circ}C$	7.388	7.5	7.613	V
	$I_{REF} = 0mA$	7.313	7.5	7.688	V
Load Regulation	$I_{REF} = 1$ to $10$ mA	-15		15	mV
Line Regulation	$V_{CC} = 15$ to $35V$	-10		10	mV
Short Circuit Current	$REF = 0V$	20	45	65	mA
<b>Oscillator</b>					
Initial Accuracy	$T_A = 25^{\circ}C$	170	200	230	kHz
Voltage Stability	$V_{CC} = 12$ to $18V$		1		%
Total Variation	Line, Temp.	160		240	kHz
Ramp Amplitude (P-P)	Outputs at 0% duty cycle	4.7		5.7	V
Ramp Valley Voltage		1.1		1.6	V
<b>Enable/OVP/Current Limit</b>					
Enable Threshold			1.8	2.2	V
OVP Threshold			7.5	7.66	V
OVP Hysteresis		200	400	600	mV
OVP Propagation Delay			200		ns
OVP Input Bias Current	$V = 7.5V$		1	10	$\mu A$
PKLIMIT Threshold		1.25	1.5	1.75	V
PKLIMIT Input Current	$V_{PKLIMIT} = 1.5V$		100		$\mu A$
PKLIMIT Prop. Delay			100		ns
<b>Multiplier</b>					
Output Current - IAC Limited	$I_{AC} = 100\mu A$ , $V_{RMS} = 1V$	-235	-205	-175	$\mu A$
Output Current - Zero	$I_{AC} = 0\mu A$	-2	-0.2	2	$\mu A$
Output Current - Power Limited	$V_{RMS} = 1.5V$ , $V_{AOUT} = 5.5V$	-250	-209	-160	$\mu A$
Output Current	$V_{RMS} = 1.5V$ , $V_{AOUT} = 2V$		-26		$\mu A$
	$V_{RMS} = 1.5V$ , $V_{AOUT} = 5V$		-190		$\mu A$
	$V_{RMS} = 5V$ , $V_{AOUT} = 2V$		-3		$\mu A$
	$V_{RMS} = 5V$ , $V_{AOUT} = 5V$		-17		$\mu A$
Gain Constant	Refer to Note 1	-0.95	-0.85	-0.75	1/V
<b>Gate Driver Output</b>					
Output High Voltage	$I_{OUT} = -200mA$ , $V_{CC} = 15V$	12	12.8		V
Output Low Voltage	$I_{OUT} = 200mA$		1	2.2	V
Output Low Voltage	$I_{OUT} = 10mA$		300	500	mV
Output Low (UVLO)	$I_{OUT} = 50mA$ , $V_{CC} = 0V$		0.9	1.5	V
Output RISE/FALL Time	$C_{LOAD} = 1nF$		35		ns
Output Peak Current	$C_{LOAD} = 10nF$		1.5		A

**ELECTRICAL CHARACTERISTICS:** Unless otherwise specified: VCC = 18V, RT = 15k, RVS = 23k, CT = 470pF, CI = 150pF, VRMS = 1.5V, IAC = 100μA, ISENSE = 0V, CAOUT = 4V, VAOUT = 3.5V, VSENSE = 3V. -40°C to 85°C (UC2855A/B), 0°C to 70°C (UC3855A/B).

PARAMETER	TEST CONDITIONS	MIN	TYP	MAX	UNITS
<b>ZVT</b>					
Reset Threshold		2.3	2.6	2.9	V
Input Bias Current	V = 2.5V, VCT = 0		6	20	μA
Propagation Delay	Measured at ZVTOUT		100		ns
Maximum Pulse Width			400		ns
Output High Voltage	IOUT = -100mA, VCC = 15V	12	12.8		V
Output Low Voltage	IOUT = 100mA		1	2.2	V
	IOUT = 10mA		300	900	mV
Output Low (UVLO)	IOUT = 50mA, VCC = 0V		0.9	1.5	V
Output RISE/FALL Time	CLOAD = 1nF		35		ns
Output Peak Current	CLOAD = 10nF		0.75		A
<b>Current Synthesizer</b>					
ION to CS Offset	VION = 0V		30	50	mV
CI Discharge Current	IAC = 50μA	105	118	140	μA
	IAC = 500μA		5		μA
IAC Offset Voltage		0.3	0.65	1.1	V
ION Buffer Slew Rate			10		V/μs
ION Input Bias Current	VION = 2V		2	15	μA
RVS Output Voltage	23k from RVS to GND	2.87	3	3.13	V

Note 1: Gain constant (K) =  $\frac{IAC \cdot (VA_{OUT} - 1.5V)}{(V_{RMS}^2 \cdot IMO)}$  at VRMS = 1.5V, VAOUT = 5.5V.

## PIN DESCRIPTIONS

**CA** This is the inverting input to the current amplifier. Connect the required compensation components between this pin and CAOUT. The common mode operating range for this input is between -0.3V and 5V.

**CAO:** This is the output of the wide bandwidth current amplifier and one of the inputs to the PWM duty cycle comparator. The output signal generated by this amplifier commands the PWM to force the correct input current. The output can swing from 0.1V to 7.5V.

**CI:** The level shifted current sense signal is impressed upon a capacitor connected between this pin and GND. The buffered current sense transformer signal charges the capacitor when the boost switch is on. When the switch is off, the current synthesizer discharges the capacitor at a rate proportional to the di/dt of the boost inductor current. In this way, the discharge current is approximately equal to

$$\frac{3V}{RRVS} - \frac{IAC}{4}$$

Discharging the CI capacitor in this fashion, a “reconstructed” version of the inductor current is generated using only one current sense transformer.

**CS:** The reconstructed inductor current waveform generated on the CI pin is level shifted down a diode drop to this pin. Connect the current amplifier input resistor between CS and the inverting input of the current amplifier. The waveform on this pin is compared to the multiplier output waveform through the average current sensing current amplifier. The input to the peak current limiting comparator is also connected to this pin. A voltage level greater than 1.5 volts on this pin will trip the comparator and disable the gate driver output.

**CT:** A capacitor from CT to GND sets the PWM oscillator frequency according to the following equation:

$$f \approx \frac{1}{11200 \cdot CT}$$

Use a high quality ceramic capacitor with low ESL and ESR for best results. A minimum CT value of 200pF insures good accuracy and less susceptibility to circuit layout parasitics. The oscillator and PWM are designed to provide practical operation to 500kHz.

**GND:** All voltages are measured with respect to this pin. All bypass and timing capacitors connected to GND should have leads as short and direct as possible.

## PIN DESCRIPTIONS (cont.)

**GTOUT:** The output of the PWM is a 1.5A peak totem pole MOSFET gate driver on GTOUT. A series resistor between GTOUT and the MOSFET gate of at least 10 ohms should be used to limit the overshoot on GTOUT. In addition, a low  $V_F$  Schottky diode should be connected between GTOUT and GND to limit undershoot and possible erratic operation.

**IAC:** This is a current input to the multiplier. The current into this pin should correspond to the instantaneous value of the rectified AC input line voltage. This is accomplished by connecting a resistor directly between IAC and the rectified input line voltage. The nominal 650mV level present on IAC negates the need for any additional compensating resistors to accommodate for the zero crossings of the line. A current equal to one fourth of the IAC current forms one of the inductor current synthesizer inputs.

**IMO:** This is the output of the multiplier, and the non-inverting input of the current amplifier. Since this output is a current, connect a resistor between this pin and ground equal in value to the input resistor of the current amplifier. The common mode operating range for this pin is  $-0.3V$  to  $5V$ .

**ION:** This pin is the current sensing input. It should be connected to the secondary side output of a current sensing transformer whose primary winding is in series with the boost switch. The resultant signal applied to this input is buffered and level shifted up a diode to the CI capacitor on the CI pin. The ION buffer has a source only output. Discharge of the CI cap is enabled through the current synthesizer circuitry. The current sense transformer termination resistor should be designed to obtain a 1V input signal amplitude at peak switch current.

**OVP:** This pin senses the boost output voltage through a voltage divider. The enable comparator input is TTL compatible and can be used as a remote shutdown port. A voltage level below 1.8V, disables  $V_{REF}$ , oscillator, and the PWM circuitry via the enable comparator. Between 1.8V and  $V_{REF}$  (7.5V) the UC is enabled. Voltage levels above 7.5V will set the PWM latch via the hysteretic OVP comparator and disable both ZVTOUT and GTOUT until the OVP level has decayed by the nominal hysteresis of 400mV. If the voltage divider is designed to initiate an OVP fault at 5% of OV, the internal hysteresis enables normal operation again when the output voltage has reached its nominal regulation level. Both the OVP and enable comparators have direct logical connections to the PWM output and exhibit typical propagation delays of 200ns.

**REF:** REF is the output of the precision reference. The output is capable of supplying 25mA to peripheral circuitry and is internally short circuit current limited. REF is disabled and low whenever VCC is below the UVLO threshold, and when OVP is below 1.8V. A REF "GOOD" comparator senses REF and disables the stage until REF has attained approximately 90% of its nominal value. Bypass REF to GND with a  $0.1\mu F$  or larger ceramic capacitor for best stability.

**RVS:** The nominal 3V signal present on the VSENSE pin is buffered and brought out to the RVS pin. A current proportional to the output voltage is generated by connecting a resistor between this pin and GND. This current forms the second input to the current synthesizer.

**VAO:** This is the output of the voltage amplifier. At a given input RMS voltage, the voltage on this pin will vary directly with the output load. The output swing is limited from approximately 100mV to 6V. Voltage levels below 1.5V on this pin will inhibit the multiplier output.

**VCC:** Positive supply rail for the IC. Bypass this pin to GND with a  $1\mu F$  low ESL, ESR ceramic capacitor. This pin is internally clamped to 20V. Current into this clamp should be limited to less than 10mA. The UC3855A has a 15.5V (nominal) turn on threshold with 6 volts of hysteresis while the UC3855B turns on at 10.5V with 500mV of hysteresis.

**VRMS:** This pin is the feedforward line voltage compensation input to the multiplier. A voltage on VRMS proportional to the AC input RMS voltage commands the multiplier to alter the current command signal by  $1/VRMS^2$  to maintain a constant power balance. The input to VRMS is generally derived from a two pole low pass filter/voltage divider connected to the rectified AC input voltage. This feature allows universal input supply voltage operation and faster response to input line fluctuations for the PFC boost preregulator. For most designs, a voltage level of 1.5V on this pin should correspond to low line, and 4.7V for high line. The input range for this pin extends from 0 to 5.5V.

**VSENSE:** This pin is the inverting input of the voltage amplifier and serves as the output voltage feedback point for the PFC boost converter. It senses the output voltage through a voltage divider which produces a nominal 3V. The voltage loop compensation is normally connected between this pin and VAO. The VSENSE pin must be above 1.5V at 25°C, (1.9V at  $-55^\circ C$ ) for the current synthesizer to work properly.

**PIN DESCRIPTIONS (cont.)**

**ZVS:** This pin senses when the drain voltage of the main MOSFET switch has reached approximately zero volts, and resets the ZVT latch via the ZVT comparator. A minimum and maximum ZVTOUT pulse width are programmable from this pin. To directly sense the  $\approx 400V$  drain voltage of the main switch, a blocking diode is connected between ZVS and the high voltage drain. When the drain reaches 0V, the level on ZVS is  $\approx 0.7V$  which is below the 2.6V ZVT comparator threshold. The maximum ZVTOUT

pulse width is approximately equal to the oscillator blanking period time.

**ZVTOUT:** The output of the ZVT block is a 750mA peak totem pole MOSFET gate driver on ZVTOUT. Since the ZVT MOSFET switch is typically 3X smaller than the main switch, less peak current is required from this output. Like GTOUT, a series gate resistor and Schottky diode to GND are recommended. This pin may also be used as a high current synchronization output driver.

For more information see Unitrode Applications Note U-153.

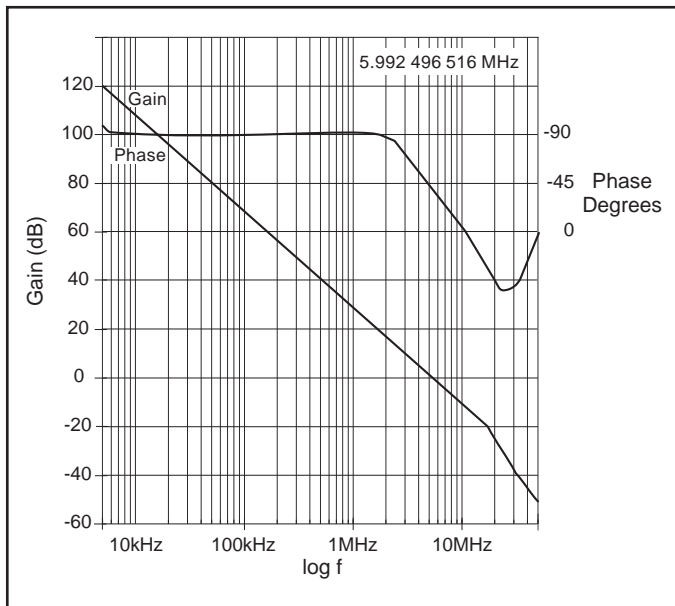

Figure 1. Current Amplifier Frequency Response

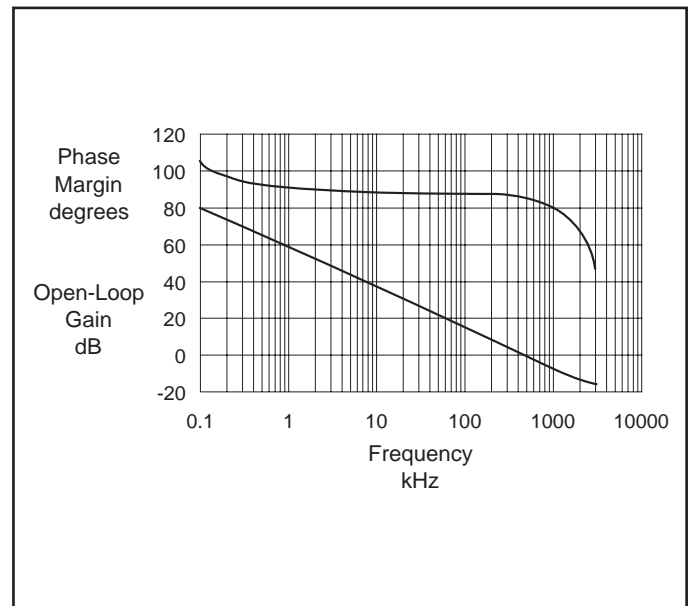

Figure 2. Voltage Amplifier Gain Phase vs Frequency

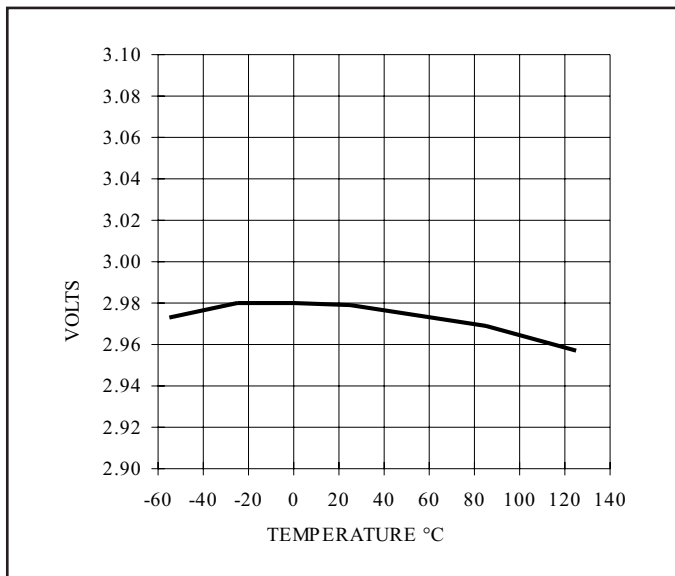

Figure 3. Voltage Amplifier Input Threshold

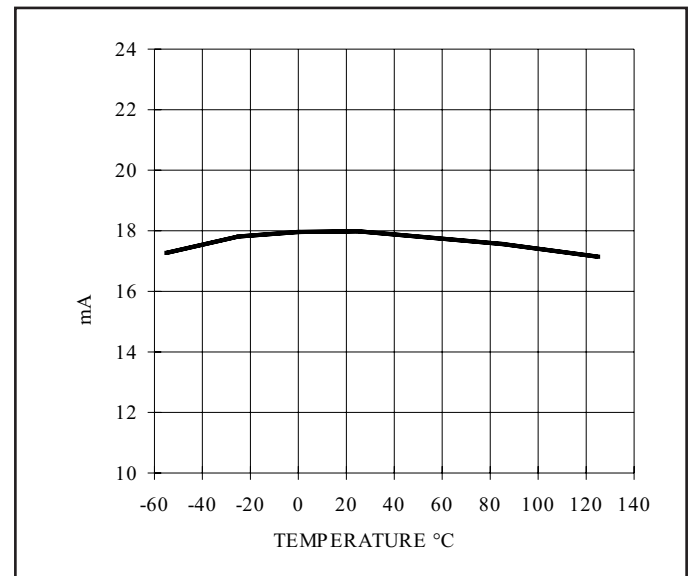

Figure 4. Supply Current ON

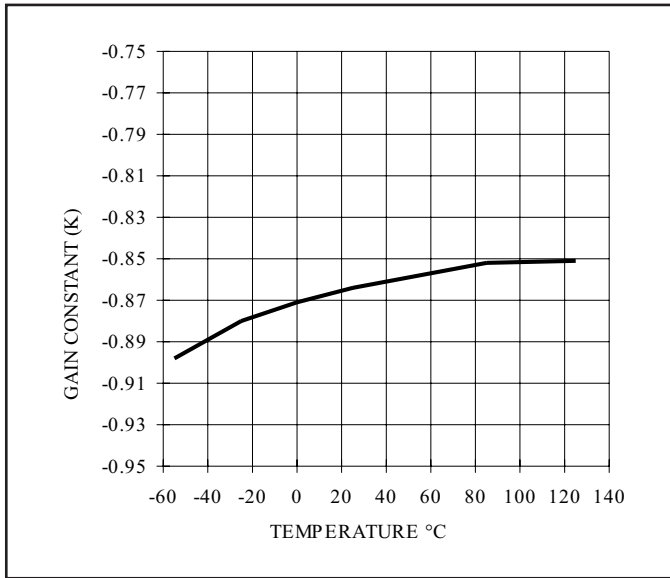

Figure 5. Multiplier Current Gain Constant

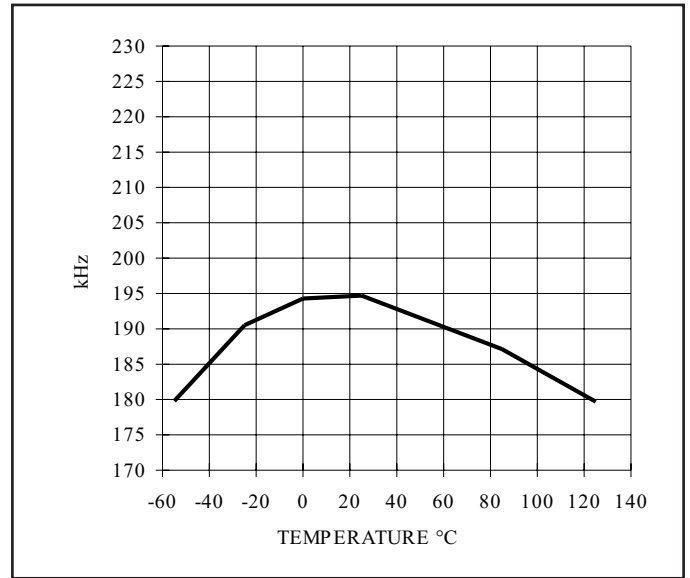

Figure 6. Oscillator Initial Accuracy



**PACKAGING INFORMATION**

Orderable Device	Status <sup>(1)</sup>	Package Type	Package Drawing	Pins	Package Qty	Eco Plan <sup>(2)</sup>	Lead/Ball Finish	MSL Peak Temp <sup>(3)</sup>
UC2855ADW	ACTIVE	SOIC	DW	20	25	Green (RoHS & no Sb/Br)	CU NIPDAU	Level-2-260C-1 YEAR
UC2855ADWTR	ACTIVE	SOIC	DW	20	2000	Green (RoHS & no Sb/Br)	CU NIPDAU	Level-2-260C-1 YEAR
UC2855ADWTRG4	ACTIVE	SOIC	DW	20	2000	Green (RoHS & no Sb/Br)	CU NIPDAU	Level-2-260C-1 YEAR
UC2855AN	ACTIVE	PDIP	N	20	20	Green (RoHS & no Sb/Br)	CU NIPDAU	Level-NC-NC-NC
UC2855BDW	ACTIVE	SOIC	DW	20	25	Green (RoHS & no Sb/Br)	CU NIPDAU	Level-2-260C-1 YEAR
UC2855BDWG4	ACTIVE	SOIC	DW	20	25	Green (RoHS & no Sb/Br)	CU NIPDAU	Level-2-260C-1 YEAR
UC2855BDWTR	ACTIVE	SOIC	DW	20	2000	Green (RoHS & no Sb/Br)	CU NIPDAU	Level-2-260C-1 YEAR
UC2855BDWTR/81363G4	PREVIEW	SOIC	DW	20		TBD	Call TI	Call TI
UC2855BDWTRG4	ACTIVE	SOIC	DW	20	2000	Green (RoHS & no Sb/Br)	CU NIPDAU	Level-2-260C-1 YEAR
UC2855BN	ACTIVE	PDIP	N	20	20	Green (RoHS & no Sb/Br)	CU NIPDAU	Level-NC-NC-NC
UC3855ADW	ACTIVE	SOIC	DW	20	25	Green (RoHS & no Sb/Br)	CU NIPDAU	Level-2-260C-1 YEAR
UC3855ADWG4	ACTIVE	SOIC	DW	20	25	Green (RoHS & no Sb/Br)	CU NIPDAU	Level-2-260C-1 YEAR
UC3855ADWTR	ACTIVE	SOIC	DW	20	2000	Green (RoHS & no Sb/Br)	CU NIPDAU	Level-2-260C-1 YEAR
UC3855ADWTRG4	ACTIVE	SOIC	DW	20	2000	Green (RoHS & no Sb/Br)	CU NIPDAU	Level-2-260C-1 YEAR
UC3855AN	ACTIVE	PDIP	N	20	20	TBD	CU NIPDAU	Level-NA-NA-NA
UC3855BDW	ACTIVE	SOIC	DW	20	25	Green (RoHS & no Sb/Br)	CU NIPDAU	Level-2-260C-1 YEAR
UC3855BDWTR	ACTIVE	SOIC	DW	20	2000	Green (RoHS & no Sb/Br)	CU NIPDAU	Level-2-260C-1 YEAR
UC3855BDWTRG4	ACTIVE	SOIC	DW	20	2000	Green (RoHS & no Sb/Br)	CU NIPDAU	Level-2-260C-1 YEAR
UC3855BN	ACTIVE	PDIP	N	20	20	Green (RoHS & no Sb/Br)	CU NIPDAU	Level-NC-NC-NC

<sup>(1)</sup> The marketing status values are defined as follows:

**ACTIVE:** Product device recommended for new designs.

**LIFEBUY:** TI has announced that the device will be discontinued, and a lifetime-buy period is in effect.

**NRND:** Not recommended for new designs. Device is in production to support existing customers, but TI does not recommend using this part in a new design.

**PREVIEW:** Device has been announced but is not in production. Samples may or may not be available.

**OBSOLETE:** TI has discontinued the production of the device.

<sup>(2)</sup> Eco Plan - The planned eco-friendly classification: Pb-Free (RoHS) or Green (RoHS & no Sb/Br) - please check <http://www.ti.com/productcontent> for the latest availability information and additional product content details.

**TBD:** The Pb-Free/Green conversion plan has not been defined.

**Pb-Free (RoHS):** TI's terms "Lead-Free" or "Pb-Free" mean semiconductor products that are compatible with the current RoHS requirements for all 6 substances, including the requirement that lead not exceed 0.1% by weight in homogeneous materials. Where designed to be soldered at high temperatures, TI Pb-Free products are suitable for use in specified lead-free processes.

**Green (RoHS & no Sb/Br):** TI defines "Green" to mean Pb-Free (RoHS compatible), and free of Bromine (Br) and Antimony (Sb) based flame

retardants (Br or Sb do not exceed 0.1% by weight in homogeneous material)

(3) MSL, Peak Temp. -- The Moisture Sensitivity Level rating according to the JEDEC industry standard classifications, and peak solder temperature.

**Important Information and Disclaimer:**The information provided on this page represents TI's knowledge and belief as of the date that it is provided. TI bases its knowledge and belief on information provided by third parties, and makes no representation or warranty as to the accuracy of such information. Efforts are underway to better integrate information from third parties. TI has taken and continues to take reasonable steps to provide representative and accurate information but may not have conducted destructive testing or chemical analysis on incoming materials and chemicals. TI and TI suppliers consider certain information to be proprietary, and thus CAS numbers and other limited information may not be available for release.

In no event shall TI's liability arising out of such information exceed the total purchase price of the TI part(s) at issue in this document sold by TI to Customer on an annual basis.

N (R-PDIP-T\*\*)

PLASTIC DUAL-IN-LINE PACKAGE

16 PINS SHOWN



- NOTES:
- A. All linear dimensions are in inches (millimeters).
  - B. This drawing is subject to change without notice.
  - Falls within JEDEC MS-001, except 18 and 20 pin minimum body length (Dim A).
  - The 20 pin end lead shoulder width is a vendor option, either half or full width.

DW (R-PDSO-G20)

PLASTIC SMALL-OUTLINE PACKAGE



- NOTES:
- A. All linear dimensions are in inches (millimeters).
  - B. This drawing is subject to change without notice.
  - C. Body dimensions do not include mold flash or protrusion not to exceed 0.006 (0,15).
  - D. Falls within JEDEC MS-013 variation AC.

## IMPORTANT NOTICE

Texas Instruments Incorporated and its subsidiaries (TI) reserve the right to make corrections, modifications, enhancements, improvements, and other changes to its products and services at any time and to discontinue any product or service without notice. Customers should obtain the latest relevant information before placing orders and should verify that such information is current and complete. All products are sold subject to TI's terms and conditions of sale supplied at the time of order acknowledgment.

TI warrants performance of its hardware products to the specifications applicable at the time of sale in accordance with TI's standard warranty. Testing and other quality control techniques are used to the extent TI deems necessary to support this warranty. Except where mandated by government requirements, testing of all parameters of each product is not necessarily performed.

TI assumes no liability for applications assistance or customer product design. Customers are responsible for their products and applications using TI components. To minimize the risks associated with customer products and applications, customers should provide adequate design and operating safeguards.

TI does not warrant or represent that any license, either express or implied, is granted under any TI patent right, copyright, mask work right, or other TI intellectual property right relating to any combination, machine, or process in which TI products or services are used. Information published by TI regarding third-party products or services does not constitute a license from TI to use such products or services or a warranty or endorsement thereof. Use of such information may require a license from a third party under the patents or other intellectual property of the third party, or a license from TI under the patents or other intellectual property of TI.

Reproduction of information in TI data books or data sheets is permissible only if reproduction is without alteration and is accompanied by all associated warranties, conditions, limitations, and notices. Reproduction of this information with alteration is an unfair and deceptive business practice. TI is not responsible or liable for such altered documentation.

Resale of TI products or services with statements different from or beyond the parameters stated by TI for that product or service voids all express and any implied warranties for the associated TI product or service and is an unfair and deceptive business practice. TI is not responsible or liable for any such statements.

Following are URLs where you can obtain information on other Texas Instruments products and application solutions:

<b>Products</b>		<b>Applications</b>	
Amplifiers	<a href="http://amplifier.ti.com">amplifier.ti.com</a>	Audio	<a href="http://www.ti.com/audio">www.ti.com/audio</a>
Data Converters	<a href="http://dataconverter.ti.com">dataconverter.ti.com</a>	Automotive	<a href="http://www.ti.com/automotive">www.ti.com/automotive</a>
DSP	<a href="http://dsp.ti.com">dsp.ti.com</a>	Broadband	<a href="http://www.ti.com/broadband">www.ti.com/broadband</a>
Interface	<a href="http://interface.ti.com">interface.ti.com</a>	Digital Control	<a href="http://www.ti.com/digitalcontrol">www.ti.com/digitalcontrol</a>
Logic	<a href="http://logic.ti.com">logic.ti.com</a>	Military	<a href="http://www.ti.com/military">www.ti.com/military</a>
Power Mgmt	<a href="http://power.ti.com">power.ti.com</a>	Optical Networking	<a href="http://www.ti.com/opticalnetwork">www.ti.com/opticalnetwork</a>
Microcontrollers	<a href="http://microcontroller.ti.com">microcontroller.ti.com</a>	Security	<a href="http://www.ti.com/security">www.ti.com/security</a>
		Telephony	<a href="http://www.ti.com/telephony">www.ti.com/telephony</a>
		Video & Imaging	<a href="http://www.ti.com/video">www.ti.com/video</a>
		Wireless	<a href="http://www.ti.com/wireless">www.ti.com/wireless</a>

Mailing Address: Texas Instruments  
Post Office Box 655303 Dallas, Texas 75265