

# SN54LV125A, SN74LV125A QUADRUPLE BUS BUFFER GATES WITH 3-STATE OUTPUTS

SCES124L – DECEMBER 1997 – REVISED APRIL 2005

- 2-V to 5.5-V  $V_{CC}$  Operation
- Max  $t_{pd}$  of 6 ns at 5 V
- Typical  $V_{OLP}$  (Output Ground Bounce)  $<0.8$  V at  $V_{CC} = 3.3$  V,  $T_A = 25^\circ\text{C}$
- Typical  $V_{OHV}$  (Output  $V_{OH}$  Undershoot)  $>2.3$  V at  $V_{CC} = 3.3$  V,  $T_A = 25^\circ\text{C}$
- Support Mixed-Mode Voltage Operation on All Ports
- $I_{off}$  Supports Partial-Power-Down Mode Operation
- Latch-Up Performance Exceeds 250 mA Per JESD 17
- ESD Protection Exceeds JESD 22
  - 2000-V Human-Body Model (A114-A)
  - 200-V Machine Model (A115-A)
  - 1000-V Charged-Device Model (C101)

SN54LV125A ... J OR W PACKAGE  
SN74LV125A ... D, DB, DGV, N, NS,  
OR PW PACKAGE  
(TOP VIEW)

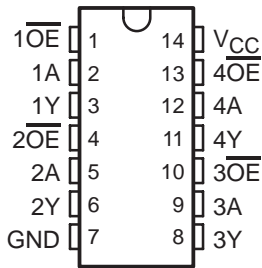

SN74LV125A ... RGY PACKAGE  
(TOP VIEW)

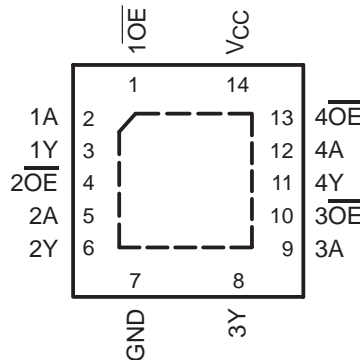

SN54LV125A ... FK PACKAGE  
(TOP VIEW)

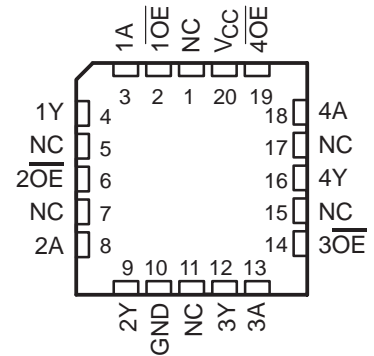

NC – No internal connection

## description/ordering information

The 'LV125A quadruple bus buffer gates are designed for 2-V to 5.5-V  $V_{CC}$  operation.

These devices feature independent line drivers with 3-state outputs. Each output is disabled when the associated output-enable ( $\overline{OE}$ ) input is high.

## ORDERING INFORMATION

$T_A$	PACKAGE†		ORDERABLE PART NUMBER	TOP-SIDE MARKING
-40°C to 85°C	PDIP – N	Tube of 25	SN74LV125AN	SN74LV125AN
	QFN – RGY	Reel of 1000	SN74LV125ARGYR	LV125A
	SOIC – D	Tube of 50	SN74LV125AD	LV125A
		Reel of 2500	SN74LV125ADR	
	SOP – NS	Reel of 2000	SN74LV125ANSR	74LV125A
	SSOP – DB	Reel of 2000	SN74LV125ADBR	LV125A
	TSSOP – PW	Tube of 90	SN74LV125APW	LV125A
Reel of 2000		SN74LV125APWR		
Reel of 250		SN74LV125APWT		
TVSOP – DGV	Reel of 2000	SN74LV125ADGVR	LV125A	
-55°C to 125°C	CDIP – J	Tube of 25	SNJ54LV125AJ	SNJ54LV125AJ
	CFP – W	Tube of 150	SNJ54LV125AW	SNJ54LV125AW
	LCCC – FK	Tube of 55	SNJ54LV125AFK	SNJ54LV125AFK

† Package drawings, standard packing quantities, thermal data, symbolization, and PCB design guidelines are available at [www.ti.com/sc/package](http://www.ti.com/sc/package).



Please be aware that an important notice concerning availability, standard warranty, and use in critical applications of Texas Instruments semiconductor products and disclaimers thereto appears at the end of this data sheet.

UNLESS OTHERWISE NOTED this document contains PRODUCTION DATA information current as of publication date. Products conform to specifications per the terms of Texas Instruments standard warranty. Production processing does not necessarily include testing of all parameters.

 **TEXAS  
INSTRUMENTS**

POST OFFICE BOX 655303 • DALLAS, TEXAS 75265

Copyright © 2005, Texas Instruments Incorporated

# SN54LV125A, SN74LV125A QUADRUPLE BUS BUFFER GATES WITH 3-STATE OUTPUTS

SCES124L – DECEMBER 1997 – REVISED APRIL 2005

## description/ordering information (continued)

To ensure the high-impedance state during power up or power down,  $\overline{OE}$  should be tied to  $V_{CC}$  through a pullup resistor; the minimum value of the resistor is determined by the current-sinking capability of the driver.

These devices are fully specified for partial-power-down applications using  $I_{off}$ . The  $I_{off}$  circuitry disables the outputs, preventing damaging current backflow through the devices when they are powered down.

FUNCTION TABLE  
(each buffer)

INPUTS		OUTPUT
$\overline{OE}$	A	Y
L	H	H
L	L	L
H	X	Z

## logic diagram (positive logic)

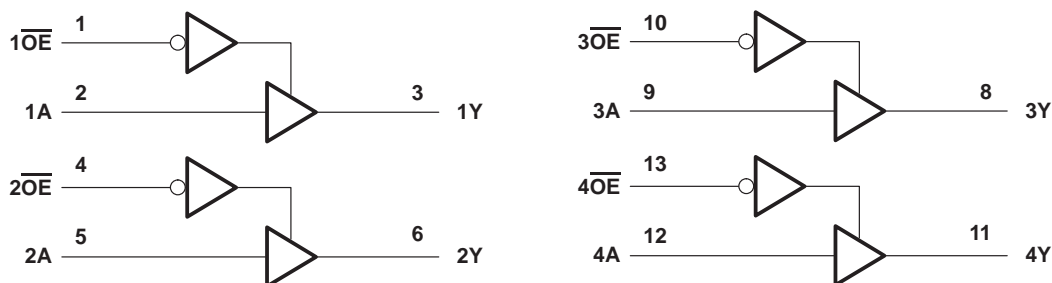

Pin numbers shown are for the D, DB, DGV, J, N, NS, PW, RGY, and W packages.

**SN54LV125A, SN74LV125A**  
**QUADRUPLE BUS BUFFER GATES**  
**WITH 3-STATE OUTPUTS**

SCES124L – DECEMBER 1997 – REVISED APRIL 2005

**absolute maximum ratings over operating free-air temperature range (unless otherwise noted)†**

Supply voltage range, $V_{CC}$ .....	–0.5 V to 7 V
Input voltage range, $V_I$ (see Note 1) .....	–0.5 V to 7 V
Voltage range applied to any output in the high-impedance or power-off state, $V_O$ (see Note 1) .....	–0.5 V to 7 V
Output voltage range, $V_O$ (see Notes 1 and 2) .....	–0.5 V to $V_{CC} + 0.5$ V
Input clamp current, $I_{IK}$ ( $V_I < 0$ ) .....	–20 mA
Output clamp current, $I_{OK}$ ( $V_O < 0$ ) .....	–50 mA
Continuous output current, $I_O$ ( $V_O = 0$ to $V_{CC}$ ) .....	±35 mA
Continuous current through $V_{CC}$ or GND .....	±70 mA
Package thermal impedance, $\theta_{JA}$ (see Note 3): D package .....	86°C/W
(see Note 3): DB package .....	96°C/W
(see Note 3): DGV package .....	127°C/W
(see Note 3): N package .....	80°C/W
(see Note 3): NS package .....	76°C/W
(see Note 3): PW package .....	113°C/W
(see Note 4): RGY package .....	47°C/W
Storage temperature range, $T_{stg}$ .....	–65°C to 150°C

† Stresses beyond those listed under “absolute maximum ratings” may cause permanent damage to the device. These are stress ratings only, and functional operation of the device at these or any other conditions beyond those indicated under “recommended operating conditions” is not implied. Exposure to absolute-maximum-rated conditions for extended periods may affect device reliability.

- NOTES:
1. The input and output negative-voltage ratings may be exceeded if the input and output current ratings are observed.
  2. This value is limited to 5.5 V maximum.
  3. The package thermal impedance is calculated in accordance with JESD 51-7.
  4. The package thermal impedance is calculated in accordance with JESD 51-5.



# SN54LV125A, SN74LV125A QUADRUPLE BUS BUFFER GATES WITH 3-STATE OUTPUTS

SCES124L – DECEMBER 1997 – REVISED APRIL 2005

## recommended operating conditions (see Note 5)

		SN54LV125A		SN74LV125A		UNIT	
		MIN	MAX	MIN	MAX		
$V_{CC}$	Supply voltage	2	5.5	2	5.5	V	
$V_{IH}$	High-level input voltage	$V_{CC} = 2\text{ V}$	1.5	1.5		V	
		$V_{CC} = 2.3\text{ V to }2.7\text{ V}$	$V_{CC} \times 0.7$	$V_{CC} \times 0.7$			
		$V_{CC} = 3\text{ V to }3.6\text{ V}$	$V_{CC} \times 0.7$	$V_{CC} \times 0.7$			
		$V_{CC} = 4.5\text{ V to }5.5\text{ V}$	$V_{CC} \times 0.7$	$V_{CC} \times 0.7$			
$V_{IL}$	Low-level input voltage	$V_{CC} = 2\text{ V}$	0.5	0.5		V	
		$V_{CC} = 2.3\text{ V to }2.7\text{ V}$	$V_{CC} \times 0.3$	$V_{CC} \times 0.3$			
		$V_{CC} = 3\text{ V to }3.6\text{ V}$	$V_{CC} \times 0.3$	$V_{CC} \times 0.3$			
		$V_{CC} = 4.5\text{ V to }5.5\text{ V}$	$V_{CC} \times 0.3$	$V_{CC} \times 0.3$			
$V_I$	Input voltage	0	5.5	0	5.5	V	
$V_O$	Output voltage	High or low state	0	$V_{CC}$	0	$V_{CC}$	V
		3-state	0	5.5	0	5.5	
$I_{OH}$	High-level output current	$V_{CC} = 2\text{ V}$		-50	-50	$\mu\text{A}$	
		$V_{CC} = 2.3\text{ V to }2.7\text{ V}$		-2	-2	mA	
		$V_{CC} = 3\text{ V to }3.6\text{ V}$		-8	-8		
		$V_{CC} = 4.5\text{ V to }5.5\text{ V}$		-16	-16		
$I_{OL}$	Low-level output current	$V_{CC} = 2\text{ V}$		50	50	$\mu\text{A}$	
		$V_{CC} = 2.3\text{ V to }2.7\text{ V}$		2	2	mA	
		$V_{CC} = 3\text{ V to }3.6\text{ V}$		8	8		
		$V_{CC} = 4.5\text{ V to }5.5\text{ V}$		16	16		
$\Delta t/\Delta v$	Input transition rise or fall rate	$V_{CC} = 2.3\text{ V to }2.7\text{ V}$		200	200	ns/V	
		$V_{CC} = 3\text{ V to }3.6\text{ V}$		100	100		
		$V_{CC} = 4.5\text{ V to }5.5\text{ V}$		20	20		
$T_A$	Operating free-air temperature	-55	125	-40	85	$^{\circ}\text{C}$	

NOTE 5: All unused inputs of the device must be held at  $V_{CC}$  or GND to ensure proper device operation. Refer to the TI application report, *Implications of Slow or Floating CMOS Inputs*, literature number SCBA004.

PRODUCT PREVIEW information concerns products in the formative or design phase of development. Characteristic data and other specifications are design goals. Texas Instruments reserves the right to change or discontinue these products without notice.



POST OFFICE BOX 655303 • DALLAS, TEXAS 75265

# SN54LV125A, SN74LV125A QUADRUPLE BUS BUFFER GATES WITH 3-STATE OUTPUTS

SCES124L – DECEMBER 1997 – REVISED APRIL 2005

**electrical characteristics over recommended operating free-air temperature range (unless otherwise noted)**

PARAMETER	TEST CONDITIONS	V <sub>CC</sub>	SN54LV125A			SN74LV125A			UNIT
			MIN	TYP	MAX	MIN	TYP	MAX	
V <sub>OH</sub>	I <sub>OH</sub> = -50 μA	2 V to 5.5 V	V <sub>CC</sub> -0.1			V <sub>CC</sub> -0.1			V
	I <sub>OH</sub> = -2 mA	2.3 V	2			2			
	I <sub>OH</sub> = -8 mA	3 V	2.48			2.48			
	I <sub>OH</sub> = -16 mA	4.5 V	3.8			3.8			
V <sub>OL</sub>	I <sub>OL</sub> = 50 μA	2 V to 5.5 V				0.1			V
	I <sub>OL</sub> = 2 mA	2.3 V				0.4			
	I <sub>OL</sub> = 8 mA	3 V				0.44			
	I <sub>OL</sub> = 16 mA	4.5 V				0.55			
I <sub>I</sub>	V <sub>I</sub> = 5.5 V or GND	0 to 5.5 V	±1			±1			μA
I <sub>OZ</sub>	V <sub>O</sub> = V <sub>CC</sub> or GND	5.5 V	±5			±5			μA
I <sub>CC</sub>	V <sub>I</sub> = V <sub>CC</sub> or GND, I <sub>O</sub> = 0	5.5 V	20			20			μA
I <sub>off</sub>	V <sub>I</sub> or V <sub>O</sub> = 0 to 5.5 V	0	5			5			μA
C <sub>i</sub>	V <sub>I</sub> = V <sub>CC</sub> or GND	3.3 V	1.6			1.6			pF
		5 V	1.6			1.6			

**switching characteristics over recommended operating free-air temperature range, V<sub>CC</sub> = 2.5 V ± 0.2 V (unless otherwise noted) (see Figure 1)**

PARAMETER	FROM (INPUT)	TO (OUTPUT)	LOAD CAPACITANCE	T <sub>A</sub> = 25°C			SN54LV125A		SN74LV125A		UNIT
				MIN	TYP	MAX	MIN	MAX	MIN	MAX	
t <sub>pd</sub>	A	Y	C <sub>L</sub> = 15 pF	6.8*	13*	13*	1*	15.5*	1	15.5	ns
t <sub>en</sub>	$\overline{\text{OE}}$	Y		7*	13*	13*	1*	15.5*	1	15.5	
t <sub>dis</sub>	$\overline{\text{OE}}$	Y		5.1*	14.*	14.*	1*	17*	1	17	
t <sub>pd</sub>	A	Y	C <sub>L</sub> = 50 pF	8.7	16.5	16.5	1	18.5	1	18.5	ns
t <sub>en</sub>	$\overline{\text{OE}}$	Y		8.8	16.5	16.5	1	18.5	1	18.5	
t <sub>dis</sub>	$\overline{\text{OE}}$	Y		7.3	18.2	18.2	1	20.5	1	20.5	
t <sub>sk(o)</sub>						2				2	

\* On products compliant to MIL-PRF-38535, this parameter is not production tested.

**switching characteristics over recommended operating free-air temperature range, V<sub>CC</sub> = 3.3 V ± 0.3 V (unless otherwise noted) (see Figure 1)**

PARAMETER	FROM (INPUT)	TO (OUTPUT)	LOAD CAPACITANCE	T <sub>A</sub> = 25°C			SN54LV125A		SN74LV125A		UNIT
				MIN	TYP	MAX	MIN	MAX	MIN	MAX	
t <sub>pd</sub>	A	Y	C <sub>L</sub> = 15 pF	4.8*	8*	8*	1*	9.5*	1	9.5	ns
t <sub>en</sub>	$\overline{\text{OE}}$	Y		4.8*	8*	8*	1*	9.5*	1	9.5	
t <sub>dis</sub>	$\overline{\text{OE}}$	Y		4.1*	9.7*	9.7*	1*	11.5*	1	11.5	
t <sub>pd</sub>	A	Y	C <sub>L</sub> = 50 pF	6.1	11.5	11.5	1	13	1	13	ns
t <sub>en</sub>	$\overline{\text{OE}}$	Y		6.2	11.5	11.5	1	13	1	13	
t <sub>dis</sub>	$\overline{\text{OE}}$	Y		5.5	13.2	13.2	1	15	1	15	
t <sub>sk(o)</sub>						1.5				1.5	

\* On products compliant to MIL-PRF-38535, this parameter is not production tested.

PRODUCT PREVIEW information concerns products in the formative or design phase of development. Characteristic data and other specifications are design goals. Texas Instruments reserves the right to change or discontinue these products without notice.



# SN54LV125A, SN74LV125A QUADRUPLE BUS BUFFER GATES WITH 3-STATE OUTPUTS

SCES124L – DECEMBER 1997 – REVISED APRIL 2005

switching characteristics over recommended operating free-air temperature range,  $V_{CC} = 5\text{ V} \pm 0.5\text{ V}$  (unless otherwise noted) (see Figure 1)

PARAMETER	FROM (INPUT)	TO (OUTPUT)	LOAD CAPACITANCE	$T_A = 25^\circ\text{C}$			SN54LV125A		SN74LV125A		UNIT
				MIN	TYP	MAX	MIN	MAX	MIN	MAX	
$t_{pd}$	A	Y	$C_L = 15\text{ pF}$	3.4*	5.5*	1*	6.5*	1	6.5	ns	
$t_{en}$	$\overline{\text{OE}}$	Y		3.4*	5.1*	1*	6*	1	6		
$t_{dis}$	$\overline{\text{OE}}$	Y		3.2*	6.8*	1*	8*	1	8		
$t_{pd}$	A	Y	$C_L = 50\text{ pF}$	4.3	7.5	1	8.5	1	8.5	ns	
$t_{en}$	$\overline{\text{OE}}$	Y		4.4	7.1	1	8	1	8		
$t_{dis}$	$\overline{\text{OE}}$	Y		4	8.8	1	10	1	10		
$t_{sk(o)}$						1			1		

\* On products compliant to MIL-PRF-38535, this parameter is not production tested.

noise characteristics,  $V_{CC} = 3.3\text{ V}$ ,  $C_L = 50\text{ pF}$ ,  $T_A = 25^\circ\text{C}$  (see Note 6)

PARAMETER	SN74LV125A			UNIT
	MIN	TYP	MAX	
$V_{OL(P)}$ Quiet output, maximum dynamic $V_{OL}$		0.4	0.8	V
$V_{OL(V)}$ Quiet output, minimum dynamic $V_{OL}$		-0.3	-0.8	V
$V_{OH(V)}$ Quiet output, minimum dynamic $V_{OH}$		3		V
$V_{IH(D)}$ High-level dynamic input voltage	2.31			V
$V_{IL(D)}$ Low-level dynamic input voltage			0.99	V

NOTE 6: Characteristics are for surface-mount packages only.

operating characteristics,  $T_A = 25^\circ\text{C}$

PARAMETER		TEST CONDITIONS	$V_{CC}$	TYP	UNIT
$C_{pd}$ Power dissipation capacitance	Outputs enabled	$C_L = 50\text{ pF}$ , $f = 10\text{ MHz}$	3.3 V	15.5	pF
			5 V	17.6	

PARAMETER MEASUREMENT INFORMATION

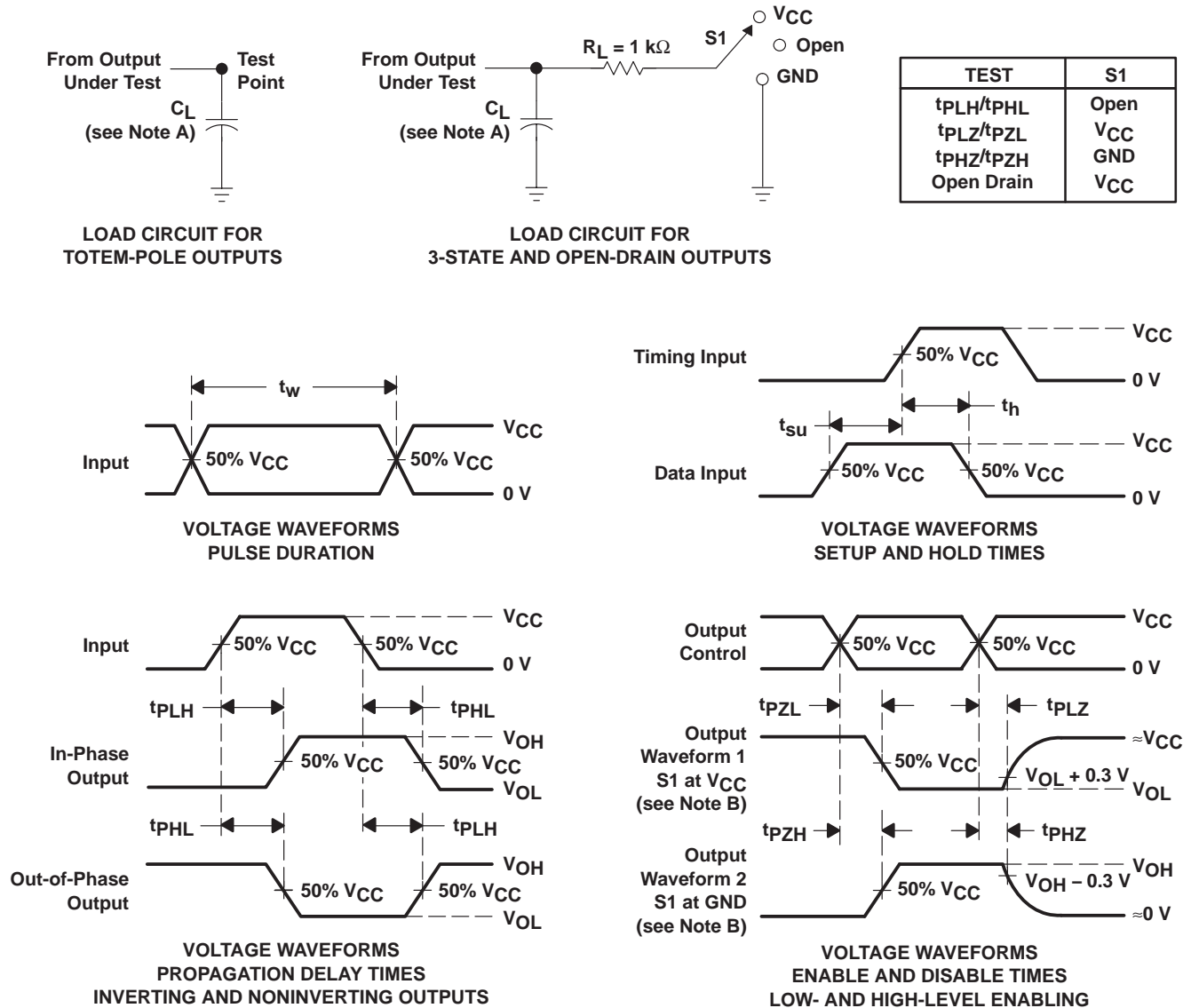

- NOTES: A.  $C_L$  includes probe and jig capacitance.  
 B. Waveform 1 is for an output with internal conditions such that the output is low, except when disabled by the output control. Waveform 2 is for an output with internal conditions such that the output is high, except when disabled by the output control.  
 C. All input pulses are supplied by generators having the following characteristics:  $PRR \leq 1\text{ MHz}$ ,  $Z_O = 50\ \Omega$ ,  $t_r \leq 3\text{ ns}$ ,  $t_f \leq 3\text{ ns}$ .  
 D. The outputs are measured one at a time, with one input transition per measurement.  
 E.  $t_{PLZ}$  and  $t_{PHZ}$  are the same as  $t_{dis}$ .  
 F.  $t_{PZL}$  and  $t_{PZH}$  are the same as  $t_{en}$ .  
 G.  $t_{PHL}$  and  $t_{PLH}$  are the same as  $t_{pd}$ .  
 H. All parameters and waveforms are not applicable to all devices.

Figure 1. Load Circuit and Voltage Waveforms

**PACKAGING INFORMATION**

Orderable Device	Status <sup>(1)</sup>	Package Type	Package Drawing	Pins	Package Qty	Eco Plan <sup>(2)</sup>	Lead/Ball Finish	MSL Peak Temp <sup>(3)</sup>
SN74LV125AD	ACTIVE	SOIC	D	14	50	Green (RoHS & no Sb/Br)	CU NIPDAU	Level-1-260C-UNLIM
SN74LV125ADBLE	OBSOLETE	SSOP	DB	14		TBD	Call TI	Call TI
SN74LV125ADBR	ACTIVE	SSOP	DB	14	2000	Green (RoHS & no Sb/Br)	CU NIPDAU	Level-1-260C-UNLIM
SN74LV125ADBRE4	ACTIVE	SSOP	DB	14	2000	Green (RoHS & no Sb/Br)	CU NIPDAU	Level-1-260C-UNLIM
SN74LV125ADE4	ACTIVE	SOIC	D	14	50	Green (RoHS & no Sb/Br)	CU NIPDAU	Level-1-260C-UNLIM
SN74LV125ADGVR	ACTIVE	TVSOP	DGV	14	2000	Green (RoHS & no Sb/Br)	CU NIPDAU	Level-1-260C-UNLIM
SN74LV125ADGVRE4	ACTIVE	TVSOP	DGV	14	2000	Green (RoHS & no Sb/Br)	CU NIPDAU	Level-1-260C-UNLIM
SN74LV125ADR	ACTIVE	SOIC	D	14	2500	Green (RoHS & no Sb/Br)	CU NIPDAU	Level-1-260C-UNLIM
SN74LV125ADRE4	ACTIVE	SOIC	D	14	2500	Green (RoHS & no Sb/Br)	CU NIPDAU	Level-1-260C-UNLIM
SN74LV125AN	ACTIVE	PDIP	N	14	25	Pb-Free (RoHS)	CU NIPDAU	N / A for Pkg Type
SN74LV125ANE4	ACTIVE	PDIP	N	14	25	Pb-Free (RoHS)	CU NIPDAU	N / A for Pkg Type
SN74LV125ANSR	ACTIVE	SO	NS	14	2000	Green (RoHS & no Sb/Br)	CU NIPDAU	Level-1-260C-UNLIM
SN74LV125ANSRG4	ACTIVE	SO	NS	14	2000	Green (RoHS & no Sb/Br)	CU NIPDAU	Level-1-260C-UNLIM
SN74LV125APW	ACTIVE	TSSOP	PW	14	90	Green (RoHS & no Sb/Br)	CU NIPDAU	Level-1-260C-UNLIM
SN74LV125APWE4	ACTIVE	TSSOP	PW	14	90	Green (RoHS & no Sb/Br)	CU NIPDAU	Level-1-260C-UNLIM
SN74LV125APWG4	ACTIVE	TSSOP	PW	14	90	Green (RoHS & no Sb/Br)	CU NIPDAU	Level-1-260C-UNLIM
SN74LV125APWLE	OBSOLETE	TSSOP	PW	14		TBD	Call TI	Call TI
SN74LV125APWR	ACTIVE	TSSOP	PW	14	2000	Green (RoHS & no Sb/Br)	CU NIPDAU	Level-1-260C-UNLIM
SN74LV125APWRE4	ACTIVE	TSSOP	PW	14	2000	Green (RoHS & no Sb/Br)	CU NIPDAU	Level-1-260C-UNLIM
SN74LV125APWRG4	ACTIVE	TSSOP	PW	14	2000	Green (RoHS & no Sb/Br)	CU NIPDAU	Level-1-260C-UNLIM
SN74LV125APWT	ACTIVE	TSSOP	PW	14	250	Green (RoHS & no Sb/Br)	CU NIPDAU	Level-1-260C-UNLIM
SN74LV125APWTE4	ACTIVE	TSSOP	PW	14	250	Green (RoHS & no Sb/Br)	CU NIPDAU	Level-1-260C-UNLIM
SN74LV125APWTG4	ACTIVE	TSSOP	PW	14	250	Green (RoHS & no Sb/Br)	CU NIPDAU	Level-1-260C-UNLIM
SN74LV125ARGYR	ACTIVE	QFN	RGY	14	1000	Green (RoHS & no Sb/Br)	CU NIPDAU	Level-2-260C-1YEAR
SN74LV125ARGYRG4	ACTIVE	QFN	RGY	14	1000	Green (RoHS & no Sb/Br)	CU NIPDAU	Level-2-260C-1YEAR

---

(1) The marketing status values are defined as follows:

**ACTIVE:** Product device recommended for new designs.

**LIFEBUY:** TI has announced that the device will be discontinued, and a lifetime-buy period is in effect.

**NRND:** Not recommended for new designs. Device is in production to support existing customers, but TI does not recommend using this part in a new design.

**PREVIEW:** Device has been announced but is not in production. Samples may or may not be available.

**OBSOLETE:** TI has discontinued the production of the device.

(2) Eco Plan - The planned eco-friendly classification: Pb-Free (RoHS), Pb-Free (RoHS Exempt), or Green (RoHS & no Sb/Br) - please check <http://www.ti.com/productcontent> for the latest availability information and additional product content details.

**TBD:** The Pb-Free/Green conversion plan has not been defined.

**Pb-Free (RoHS):** TI's terms "Lead-Free" or "Pb-Free" mean semiconductor products that are compatible with the current RoHS requirements for all 6 substances, including the requirement that lead not exceed 0.1% by weight in homogeneous materials. Where designed to be soldered at high temperatures, TI Pb-Free products are suitable for use in specified lead-free processes.

**Pb-Free (RoHS Exempt):** This component has a RoHS exemption for either 1) lead-based flip-chip solder bumps used between the die and package, or 2) lead-based die adhesive used between the die and leadframe. The component is otherwise considered Pb-Free (RoHS compatible) as defined above.

**Green (RoHS & no Sb/Br):** TI defines "Green" to mean Pb-Free (RoHS compatible), and free of Bromine (Br) and Antimony (Sb) based flame retardants (Br or Sb do not exceed 0.1% by weight in homogeneous material)

(3) MSL, Peak Temp. -- The Moisture Sensitivity Level rating according to the JEDEC industry standard classifications, and peak solder temperature.

**Important Information and Disclaimer:**The information provided on this page represents TI's knowledge and belief as of the date that it is provided. TI bases its knowledge and belief on information provided by third parties, and makes no representation or warranty as to the accuracy of such information. Efforts are underway to better integrate information from third parties. TI has taken and continues to take reasonable steps to provide representative and accurate information but may not have conducted destructive testing or chemical analysis on incoming materials and chemicals. TI and TI suppliers consider certain information to be proprietary, and thus CAS numbers and other limited information may not be available for release.

In no event shall TI's liability arising out of such information exceed the total purchase price of the TI part(s) at issue in this document sold by TI to Customer on an annual basis.

N (R-PDIP-T\*\*)

PLASTIC DUAL-IN-LINE PACKAGE

16 PINS SHOWN



- NOTES:
- A. All linear dimensions are in inches (millimeters).
  - B. This drawing is subject to change without notice.
  - Falls within JEDEC MS-001, except 18 and 20 pin minimum body length (Dim A).
  - The 20 pin end lead shoulder width is a vendor option, either half or full width.

DGV (R-PDSO-G\*\*)

PLASTIC SMALL-OUTLINE

24 PINS SHOWN





- NOTES: A. All linear dimensions are in millimeters.  
 B. This drawing is subject to change without notice.  
 C. Body dimensions do not include mold flash or protrusion, not to exceed 0,15 per side.  
 D. Falls within JEDEC: 24/48 Pins – MO-153  
 14/16/20/56 Pins – MO-194

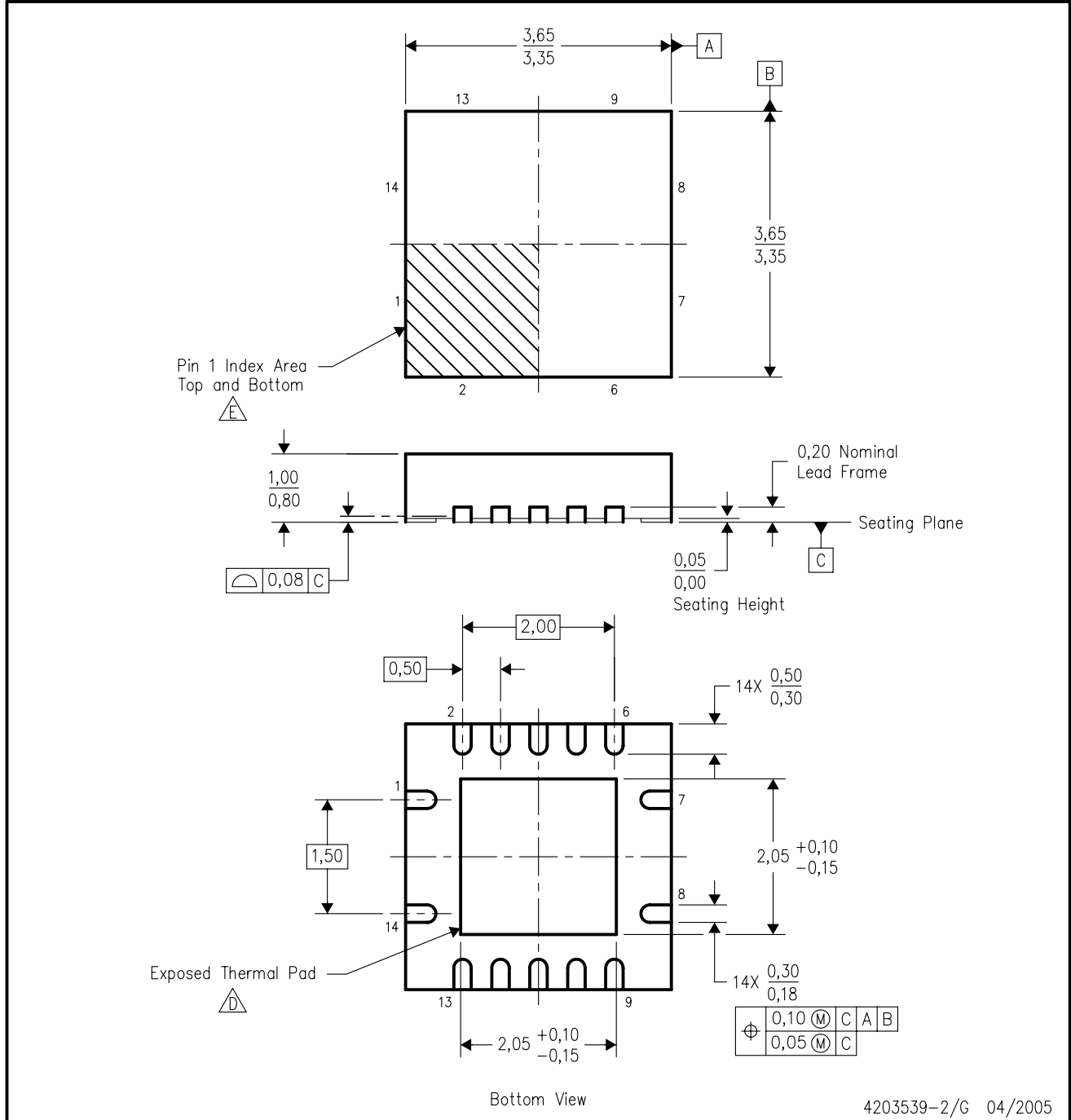

RGY (S-PQFP-N14)

PLASTIC QUAD FLATPACK



- NOTES:
- A. All linear dimensions are in millimeters. Dimensioning and tolerancing per ASME Y14.5M-1994.
  - B. This drawing is subject to change without notice.
  - C. QFN (Quad Flatpack No-Lead) package configuration.
  -  The package thermal pad must be soldered to the board for thermal and mechanical performance.
  -  Pin 1 identifiers are located on both top and bottom of the package and within the zone indicated. The Pin 1 identifiers are either a molded, marked, or metal feature.
  - F. Package complies to JEDEC MO-241 variation BA.



DB (R-PDSO-G\*\*)

PLASTIC SMALL-OUTLINE

28 PINS SHOWN



- NOTES: A. All linear dimensions are in millimeters.  
 B. This drawing is subject to change without notice.  
 C. Body dimensions do not include mold flash or protrusion not to exceed 0,15.  
 D. Falls within JEDEC MO-150

PW (R-PDSO-G\*\*)

PLASTIC SMALL-OUTLINE PACKAGE

14 PINS SHOWN



4040064/F 01/97

- NOTES: A. All linear dimensions are in millimeters.  
 B. This drawing is subject to change without notice.  
 C. Body dimensions do not include mold flash or protrusion not to exceed 0,15.  
 D. Falls within JEDEC MO-153

## IMPORTANT NOTICE

Texas Instruments Incorporated and its subsidiaries (TI) reserve the right to make corrections, modifications, enhancements, improvements, and other changes to its products and services at any time and to discontinue any product or service without notice. Customers should obtain the latest relevant information before placing orders and should verify that such information is current and complete. All products are sold subject to TI's terms and conditions of sale supplied at the time of order acknowledgment.

TI warrants performance of its hardware products to the specifications applicable at the time of sale in accordance with TI's standard warranty. Testing and other quality control techniques are used to the extent TI deems necessary to support this warranty. Except where mandated by government requirements, testing of all parameters of each product is not necessarily performed.

TI assumes no liability for applications assistance or customer product design. Customers are responsible for their products and applications using TI components. To minimize the risks associated with customer products and applications, customers should provide adequate design and operating safeguards.

TI does not warrant or represent that any license, either express or implied, is granted under any TI patent right, copyright, mask work right, or other TI intellectual property right relating to any combination, machine, or process in which TI products or services are used. Information published by TI regarding third-party products or services does not constitute a license from TI to use such products or services or a warranty or endorsement thereof. Use of such information may require a license from a third party under the patents or other intellectual property of the third party, or a license from TI under the patents or other intellectual property of TI.

Reproduction of information in TI data books or data sheets is permissible only if reproduction is without alteration and is accompanied by all associated warranties, conditions, limitations, and notices. Reproduction of this information with alteration is an unfair and deceptive business practice. TI is not responsible or liable for such altered documentation.

Resale of TI products or services with statements different from or beyond the parameters stated by TI for that product or service voids all express and any implied warranties for the associated TI product or service and is an unfair and deceptive business practice. TI is not responsible or liable for any such statements.

Following are URLs where you can obtain information on other Texas Instruments products and application solutions:

<b>Products</b>		<b>Applications</b>	
Amplifiers	<a href="http://amplifier.ti.com">amplifier.ti.com</a>	Audio	<a href="http://www.ti.com/audio">www.ti.com/audio</a>
Data Converters	<a href="http://dataconverter.ti.com">dataconverter.ti.com</a>	Automotive	<a href="http://www.ti.com/automotive">www.ti.com/automotive</a>
DSP	<a href="http://dsp.ti.com">dsp.ti.com</a>	Broadband	<a href="http://www.ti.com/broadband">www.ti.com/broadband</a>
Interface	<a href="http://interface.ti.com">interface.ti.com</a>	Digital Control	<a href="http://www.ti.com/digitalcontrol">www.ti.com/digitalcontrol</a>
Logic	<a href="http://logic.ti.com">logic.ti.com</a>	Military	<a href="http://www.ti.com/military">www.ti.com/military</a>
Power Mgmt	<a href="http://power.ti.com">power.ti.com</a>	Optical Networking	<a href="http://www.ti.com/opticalnetwork">www.ti.com/opticalnetwork</a>
Microcontrollers	<a href="http://microcontroller.ti.com">microcontroller.ti.com</a>	Security	<a href="http://www.ti.com/security">www.ti.com/security</a>
Low Power Wireless	<a href="http://www.ti.com/lpw">www.ti.com/lpw</a>	Telephony	<a href="http://www.ti.com/telephony">www.ti.com/telephony</a>
		Video & Imaging	<a href="http://www.ti.com/video">www.ti.com/video</a>
		Wireless	<a href="http://www.ti.com/wireless">www.ti.com/wireless</a>

Mailing Address: Texas Instruments  
Post Office Box 655303 Dallas, Texas 75265