

LMZ13610 10A SIMPLE SWITCHER® Power Module with 36V Maximum Input Voltage

 Check for Samples: [LMZ13610](#)

FEATURES

- Integrated Shielded Inductor
- Simple PCB Layout
- Fixed Switching Frequency (350 kHz)
- Flexible Startup Sequencing Using External Soft-start, Tracking and Precision Enable
- Protection Against Inrush Currents and Faults Such as Input UVLO and Output Short Circuit
- –40°C to 125°C Junction Temperature Range
- Single Exposed Pad and Standard Pinout for Easy Mounting and Manufacturing
- Fully enabled for WEBENCH® Power Designer
- Pin compatible with LMZ22010/08, LMZ12010/08, LMZ23610/08/06H, and LMZ13608/06H

APPLICATIONS

- Point of Load Conversions from 12V and 24V Input Rail
- Time Critical Projects
- Space Constrained / High Thermal Requirement Applications
- Negative Output Voltage Applications (See AN-2027, literature number [SNVA425](#))

PERFORMANCE BENEFITS

- High Efficiency Reduces System Heat Generation
- Low Radiated Emissions (EMI) Complies with EN55022 Class B Standard
 - EN 55022:2006, +A1:2007, FCC Part 15 Subpart B, Tested on Evaluation Board with EMI Configuration
- Only 7 External Components
- Low Output Voltage Ripple
- No External Heat Sink Required

ELECTRICAL SPECIFICATIONS

- 50W Maximum Total Output Power
- Up to 10A Output Current
- Input Voltage Range 6V to 36V
- Output Voltage Range 0.8V to 6V
- Efficiency up to 92%

DESCRIPTION

The LMZ13610 SIMPLE SWITCHER power module is an easy-to-use step-down DC-DC solution capable of driving up to 10A load. The LMZ13610 is available in an innovative package that enhances thermal performance and allows for hand or machine soldering.

The LMZ13610 can accept an input voltage rail between 6V and 36V and deliver an adjustable and highly accurate output voltage as low as 0.8V. The LMZ13610 only requires two external resistors and three external capacitors to complete the power solution. The LMZ13610 is a reliable and robust design with the following protection features: thermal shutdown, input under-voltage lockout, output over-voltage protection, short-circuit protection, output current limit, and allows startup into a pre-biased output.

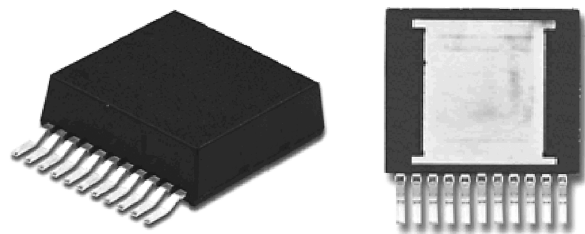

Top View

Bottom View

Figure 1. PFM 11 Pin Package
 15 x 17.79 x 5.9 mm (0.59 x 0.7 x 0.232 in)
 $\theta_{JA} = 9.9\text{ }^{\circ}\text{C/W}$, $\theta_{JC} = 1.0\text{ }^{\circ}\text{C/W}^{(1)}$
 RoHS Compliant
 Peak Reflow Case Temp = 245°C
[Power Module SMT Guidelines](#)

(1) θ_{JA} measured on a 75mm x 90mm four layer PCB



Please be aware that an important notice concerning availability, standard warranty, and use in critical applications of Texas Instruments semiconductor products and disclaimers thereto appears at the end of this data sheet.

SIMPLE SWITCHER, WEBENCH are registered trademarks of Texas Instruments.

All other trademarks are the property of their respective owners.

System Performance

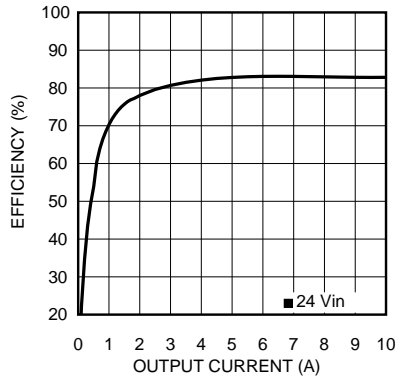

Figure 2. Efficiency $V_{IN} = 24V$ $V_{OUT} = 3.3V$

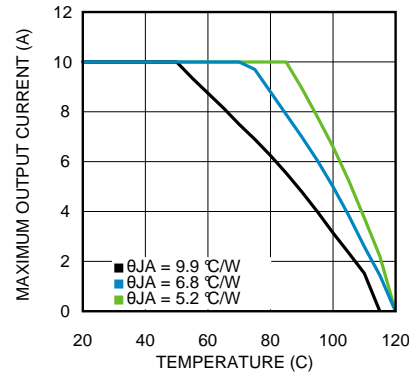

Figure 3. Thermal derating curve $V_{IN} = 24V$, $V_{OUT} = 3.3V$

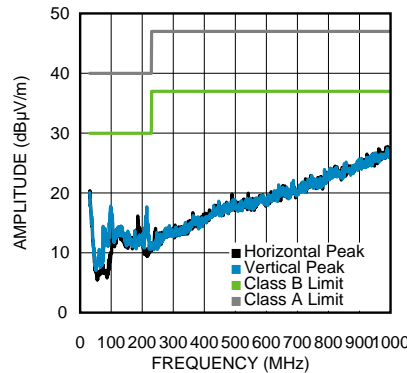
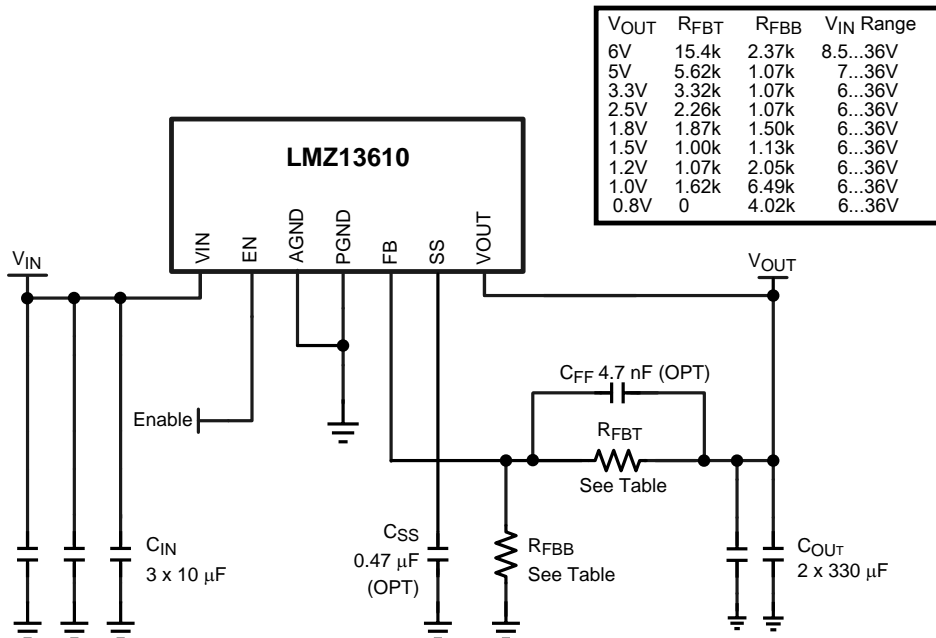
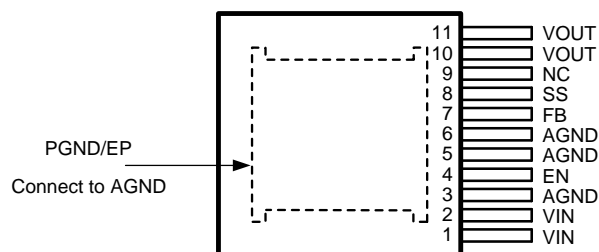

Figure 4. Radiated EMI (EN 55022) $V_{IN} = 24V$, $V_{OUT} = 5V$, $I_{OUT} = 10A$

Simplified Application Schematic



Connection Diagram



**Figure 5. Top View
11-Lead PFM**

PIN DESCRIPTIONS

| Pin | Name | Description |
|---------|------|--|
| 1, 2 | VIN | Supply input — Nominal operating range is 6V to 36V. A small amount of internal capacitance is contained within the package assembly. Additional external input capacitance is required between this pin and PGND. |
| 3, 5, 6 | AGND | Analog Ground — Reference point for all stated voltages. Must be externally connected to EP/PGND. |
| 4 | EN | Enable — Input to the precision enable comparator. Rising threshold is 1.274V typical. Once the module is enabled, a 20 uA source current is internally activated to accommodate programmable hysteresis. |
| 7 | FB | Feedback — Internally connected to the regulation, over-voltage, and short-circuit comparators. The regulation reference point is 0.8V at this input pin. Connect the feedback resistor divider between the output and AGND to set the output voltage. |
| 8 | SS | Soft-Start/Track input — To extend the 1.6 mSec internal soft-start connect an external soft start capacitor. For tracking connect to an external resistive divider connected to a higher priority supply rail. See Design Steps for the LMZ13610 Application section. |
| 9 | NC | No Connect. This pin must remain floating, do not ground. |
| 10, 11 | VOUT | Output Voltage — Output from the internal inductor. Connect the output capacitor between this pin and PGND. |
| EP | PGND | Exposed Pad / Power Ground Electrical path for the power circuits within the module. — NOT Internally connected to AGND / pin 5. Used to dissipate heat from the package during operation. Must be electrically connected to pin 5 external to the package. |



These devices have limited built-in ESD protection. The leads should be shorted together or the device placed in conductive foam during storage or handling to prevent electrostatic damage to the MOS gates.

ABSOLUTE MAXIMUM RATINGS⁽¹⁾⁽²⁾

| | |
|---|----------------|
| VIN to PGND | -0.3V to 40V |
| EN to AGND | -0.3V to 5.5V |
| SS, FB to AGND | -0.3V to 2.5V |
| AGND to PGND | -0.3V to 0.3V |
| Junction Temperature | 150°C |
| Storage Temperature Range | -65°C to 150°C |
| ESD Susceptibility ⁽³⁾ | ± 2 kV |
| For soldering specifications: see product folder at www.ti.com and literature number SNOA549 | |

- (1) Absolute Maximum Ratings are limits beyond which damage to the device may occur. Operating Ratings are conditions under which operation of the device is intended to be functional. For ensured specifications and test conditions, see the Electrical Characteristics.
- (2) If Military/Aerospace specified devices are required, please contact the Texas Instruments Sales Office/Distributors for availability and specifications.
- (3) The human body model is a 100pF capacitor discharged through a 1.5 kΩ resistor into each pin. Test method is per JESD-22-114.

OPERATING RATINGS⁽¹⁾

| | |
|--------------------------------|----------------|
| VIN | 6V to 36V |
| EN | 0V to 5.0V |
| Operation Junction Temperature | -40°C to 125°C |

- (1) Absolute Maximum Ratings are limits beyond which damage to the device may occur. Operating Ratings are conditions under which operation of the device is intended to be functional. For ensured specifications and test conditions, see the Electrical Characteristics.

ELECTRICAL CHARACTERISTICS

Limits in standard type are for $T_J = 25^\circ\text{C}$ only; limits in boldface type apply over the junction temperature (T_J) range of -40°C to $+125^\circ\text{C}$. Minimum and Maximum limits are specified through test, design or statistical correlation. Typical values represent the most likely parametric norm at $T_J = 25^\circ\text{C}$, and are provided for reference purposes only. Unless otherwise stated the following conditions apply: $V_{IN} = 12\text{V}$, $V_{OUT} = 3.3\text{V}$

| Symbol | Parameter | Conditions | Min (1) | Typ (2) | Max (1) | Units |
|--------------------------------------|-----------------------------------|--------------------------|--------------|------------|--------------|-------|
| SYSTEM PARAMETERS | | | | | | |
| Enable Control | | | | | | |
| V_{EN} | EN threshold | V_{EN} rising | 1.096 | 1.274 | 1.452 | V |
| I_{EN-HYS} | EN hysteresis source current | $V_{EN} > 1.274\text{V}$ | | 13 | | μA |
| Soft-Start | | | | | | |
| I_{SS} | SS source current | $V_{SS} = 0\text{V}$ | 40 | 50 | 60 | μA |
| t_{SS} | Internal soft-start interval | | | 1.6 | | msec |
| Current Limit | | | | | | |
| I_{CL} | Current limit threshold | d.c. average | 12.5 | | | A |
| Internal Switching Oscillator | | | | | | |
| f_{OSC} | Free-running oscillator frequency | | 314 | 359 | 404 | kHz |

- (1) Min and Max limits are 100% production tested at 25°C . Limits over the operating temperature range are specified through correlation using Statistical Quality Control (SQC) methods. Limits are used to calculate TI's Average Outgoing Quality Level (AOQL).
- (2) Typical numbers are at 25°C and represent the most likely parametric norm.

ELECTRICAL CHARACTERISTICS (continued)

Limits in standard type are for $T_J = 25^\circ\text{C}$ only; limits in boldface type apply over the junction temperature (T_J) range of -40°C to $+125^\circ\text{C}$. Minimum and Maximum limits are specified through test, design or statistical correlation. Typical values represent the most likely parametric norm at $T_J = 25^\circ\text{C}$, and are provided for reference purposes only. Unless otherwise stated the following conditions apply: $V_{IN} = 12\text{V}$, $V_{OUT} = 3.3\text{V}$

| Symbol | Parameter | Conditions | Min (1) | Typ (2) | Max (1) | Units |
|---|--|--|--------------|------------|--------------|---------------------------|
| Regulation and Over-Voltage Comparator | | | | | | |
| V_{FB} | In-regulation feedback voltage | $V_{SS} >+ 0.8\text{V}$ $I_O = 10\text{A}$ | 0.775 | 0.795 | 0.815 | V |
| V_{FB-OV} | Feedback over-voltage protection threshold | | | 0.86 | | V |
| I_{FB} | Feedback input bias current | | | 5 | | nA |
| I_Q | Non Switching Quiescent Current | | | 3 | | mA |
| I_{SD} | Shut Down Quiescent Current | $V_{EN} = 0\text{V}$ | | 32 | | μA |
| D_{max} | Maximum Duty Factor | | | 85 | | % |
| Thermal Characteristics | | | | | | |
| T_{SD} | Thermal Shutdown | Rising | | 165 | | $^\circ\text{C}$ |
| $T_{SD-HYST}$ | Thermal shutdown hysteresis | Falling | | 15 | | $^\circ\text{C}$ |
| θ_{JA} | Junction to Ambient ⁽³⁾ | Natural Convection | | 9.9 | | $^\circ\text{C}/\text{W}$ |
| | | 225 LFPM | | 6.8 | | |
| | | 500 LFPM | | 5.2 | | |
| θ_{JC} | Junction to Case | | | 1.0 | | $^\circ\text{C}/\text{W}$ |
| PERFORMANCE PARAMETERS⁽⁴⁾ | | | | | | |
| ΔV_O | Output voltage ripple | BW@ 20 MHz | | 24 | | mV _{PP} |
| $\Delta V_O/\Delta V_{IN}$ | Line regulation | $V_{IN} = 12\text{V to } 20\text{V}$, $I_{OUT} = 10\text{A}$ | | ± 0.2 | | % |
| $\Delta V_O/\Delta I_{OUT}$ | Load regulation | $V_{IN} = 12\text{V}$, $I_{OUT} = 0.001\text{A to } 10\text{A}$ | | 1 | | mV/A |
| η | Peak efficiency | $V_{IN} = 12\text{V}$ $V_{OUT} = 3.3\text{V}$ $I_{OUT} = 5\text{A}$ | | 89.5 | | % |
| η | Full load efficiency | $V_{IN} = 12\text{V}$ $V_{OUT} = 3.3\text{V}$ $I_{OUT} = 10\text{A}$ | | 87.5 | | % |

(3) Theta JA measured on a 3.0" x 3.5" four layer board, with two ounce copper on outer layers and one ounce copper on inner layers, two hundred and ten thermal vias, and 2W power dissipation. Refer to evaluation board application note layout diagrams.

(4) Refer to BOM in [Typical Application Bill of Materials](#).

TYPICAL PERFORMANCE CHARACTERISTICS

Unless otherwise specified, the following conditions apply: $V_{IN} = 12V$; $C_{IN} = \text{three } 10\mu F + 47nF \text{ X7R Ceramic}$; $C_{OUT} = \text{two } 330\mu F \text{ Specialty Polymer} + 47 \mu F \text{ Ceramic} + 47nF \text{ Ceramic}$; $C_{FF} = 4.7nF$; $T_{\text{ambient}} = 25^\circ C$ for waveforms. All indicated temperatures are ambient.

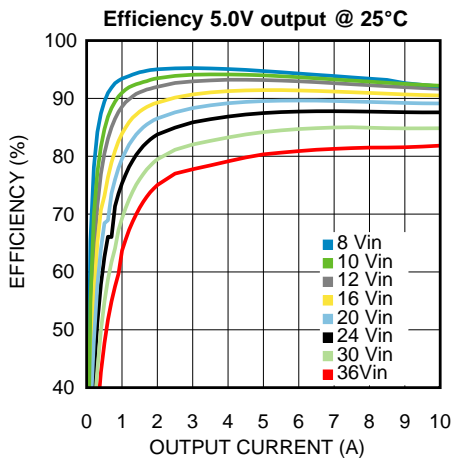

Figure 6.

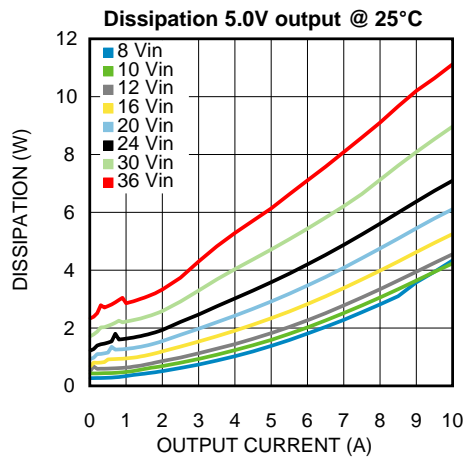

Figure 7.

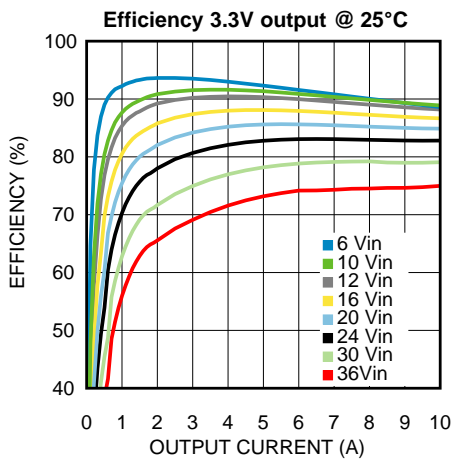

Figure 8.

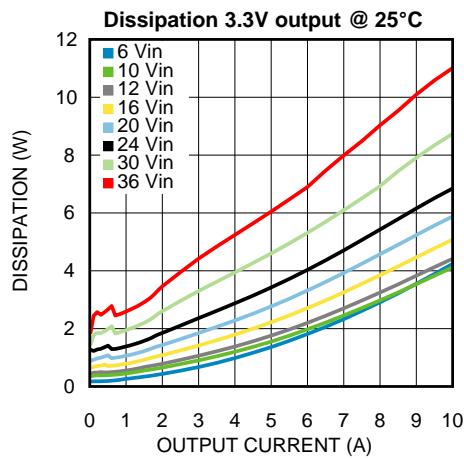

Figure 9.

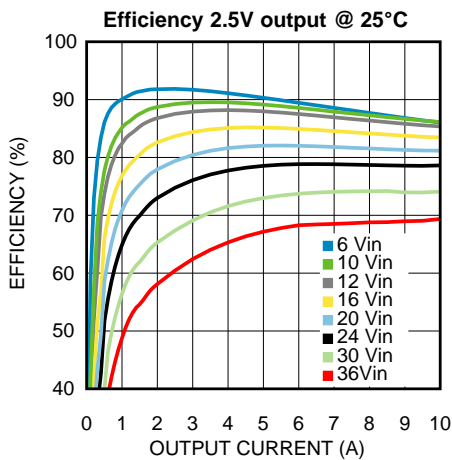

Figure 10.

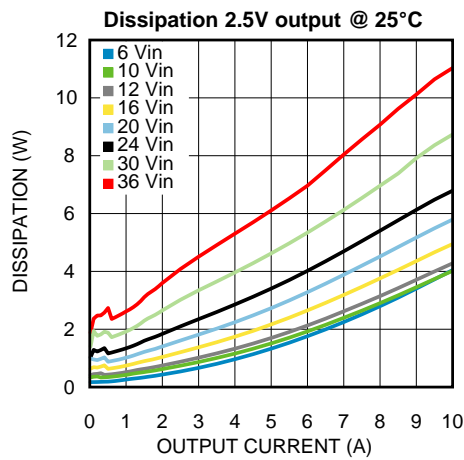

Figure 11.

TYPICAL PERFORMANCE CHARACTERISTICS (continued)

Unless otherwise specified, the following conditions apply: $V_{IN} = 12V$; $C_{IN} = \text{three} \times 10\mu F + 47nF$ X7R Ceramic; $C_{OUT} = \text{two} \times 330\mu F$ Specialty Polymer + $47 \mu F$ Ceramic + $47nF$ Ceramic; $C_{FF} = 4.7nF$; $T_{\text{ambient}} = 25^\circ C$ for waveforms. All indicated temperatures are ambient.

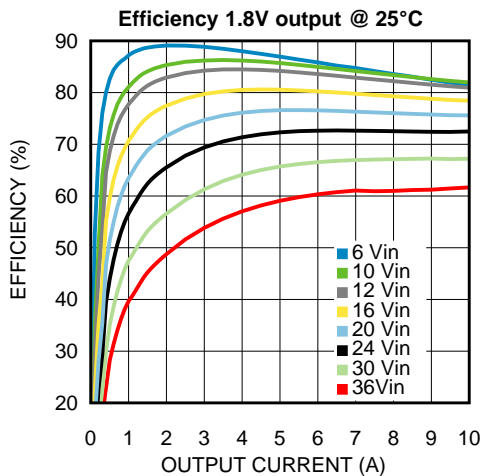

Figure 12.

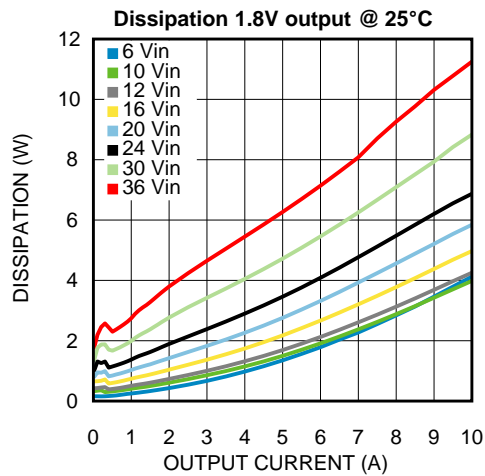

Figure 13.

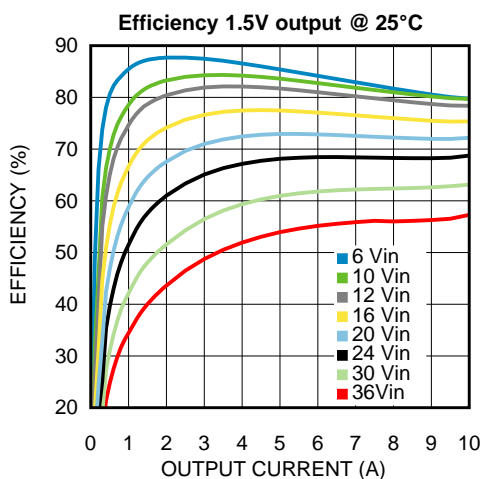

Figure 14.

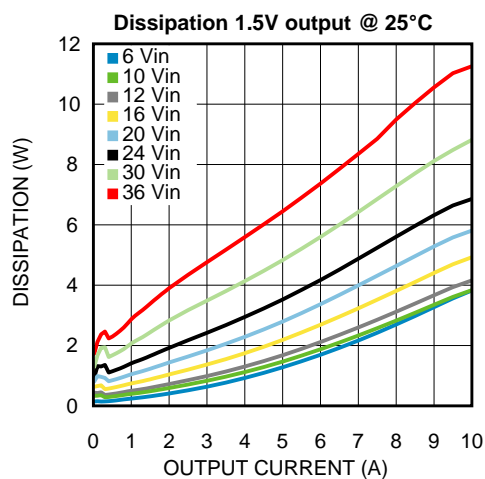

Figure 15.

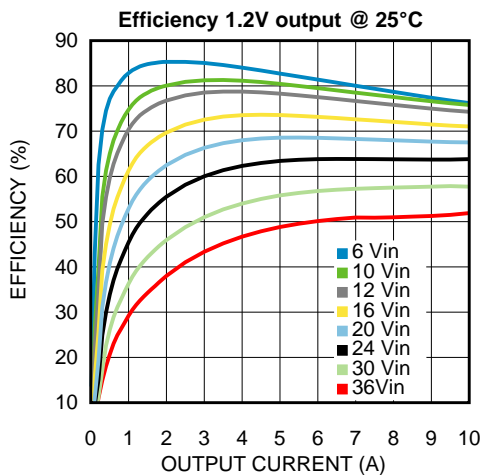

Figure 16.

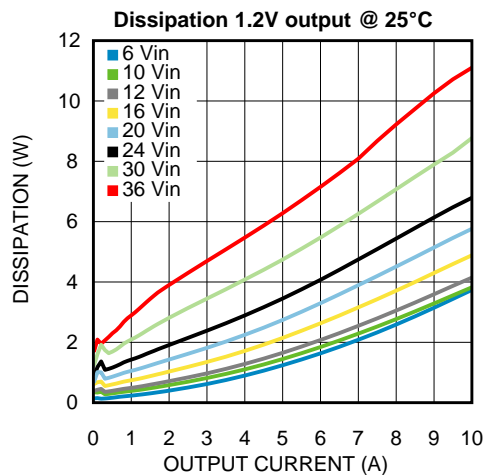

Figure 17.

TYPICAL PERFORMANCE CHARACTERISTICS (continued)

Unless otherwise specified, the following conditions apply: $V_{IN} = 12V$; $C_{IN} = \text{three } \times 10\mu F + 47nF \text{ X7R Ceramic}$; $C_{OUT} = \text{two } \times 330\mu F \text{ Specialty Polymer} + 47 \mu F \text{ Ceramic} + 47nF \text{ Ceramic}$; $C_{FF} = 4.7nF$; $T_{\text{ambient}} = 25^\circ \text{C}$ for waveforms. All indicated temperatures are ambient.

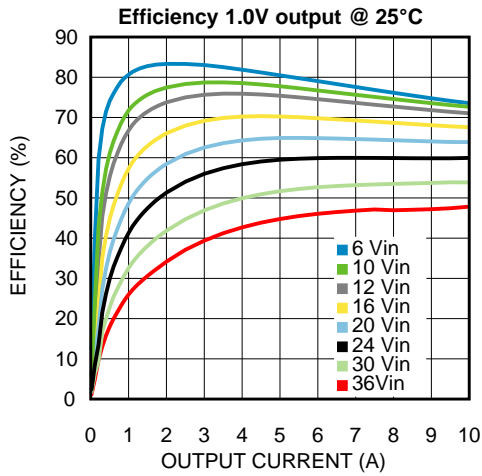

Figure 18.

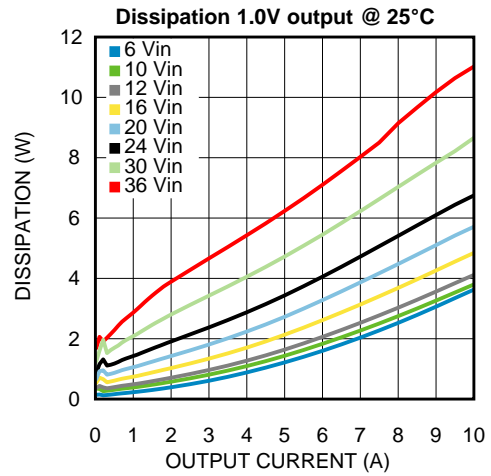

Figure 19.

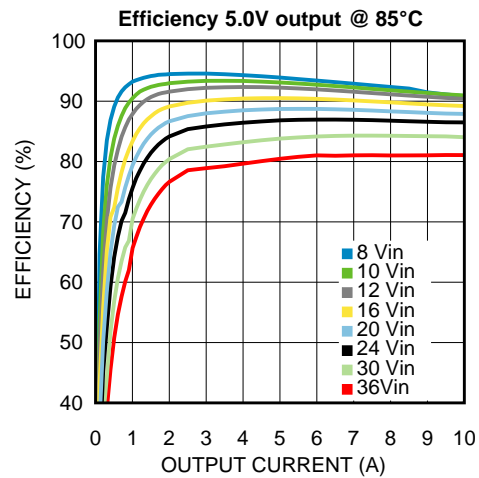

Figure 20.

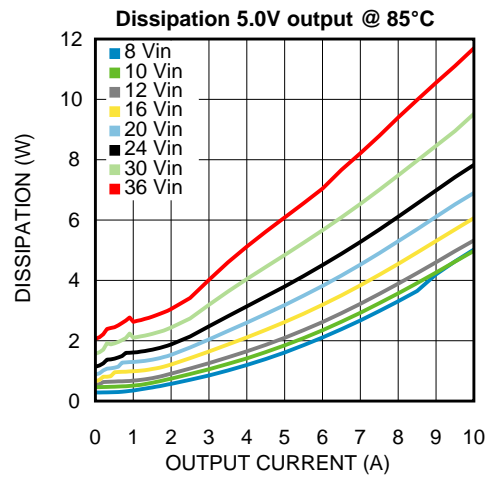

Figure 21.

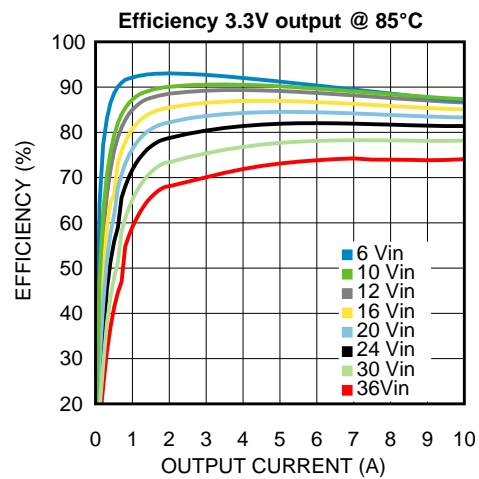

Figure 22.

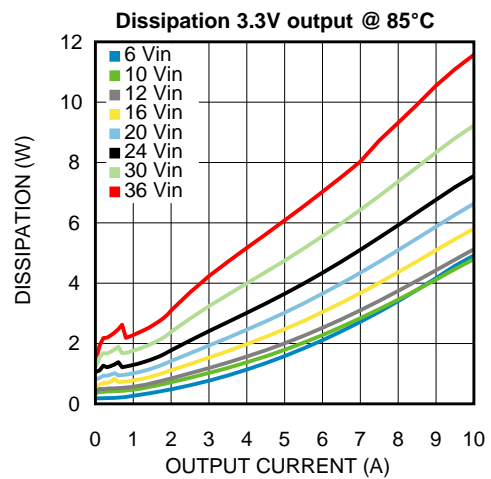

Figure 23.

TYPICAL PERFORMANCE CHARACTERISTICS (continued)

Unless otherwise specified, the following conditions apply: $V_{IN} = 12V$; $C_{IN} = \text{three } \times 10\mu F + 47nF \text{ X7R Ceramic}$; $C_{OUT} = \text{two } \times 330\mu F \text{ Specialty Polymer} + 47 \mu F \text{ Ceramic} + 47nF \text{ Ceramic}$; $C_{FF} = 4.7nF$; $T_{\text{ambient}} = 25^\circ \text{C}$ for waveforms. All indicated temperatures are ambient.

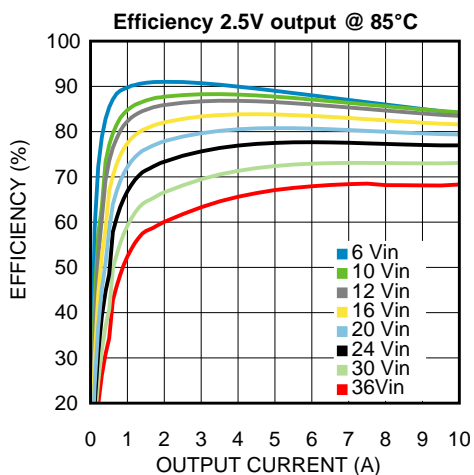

Figure 24.

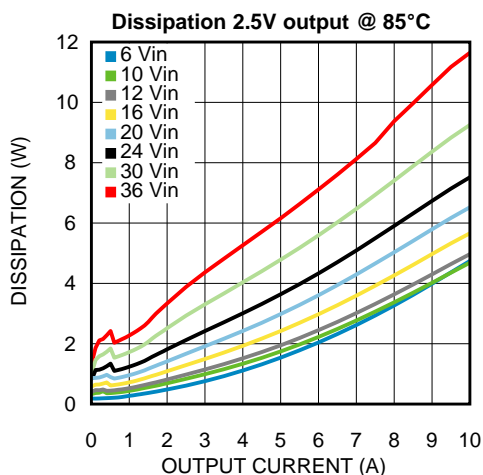

Figure 25.

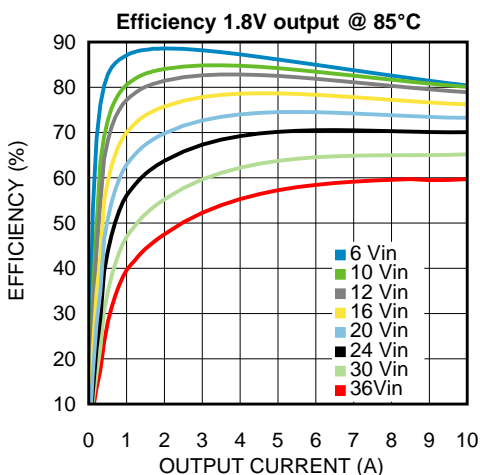

Figure 26.

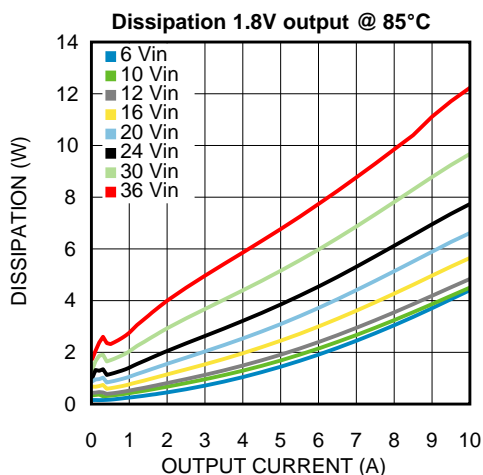

Figure 27.

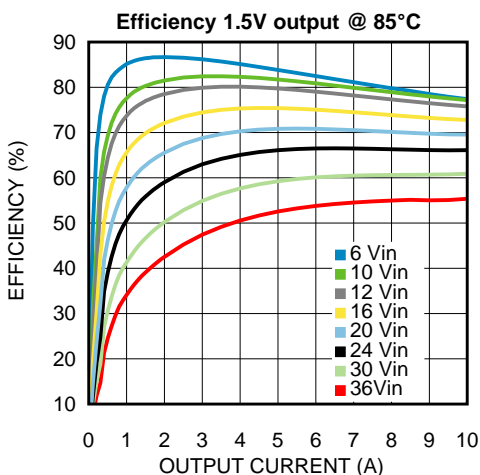

Figure 28.

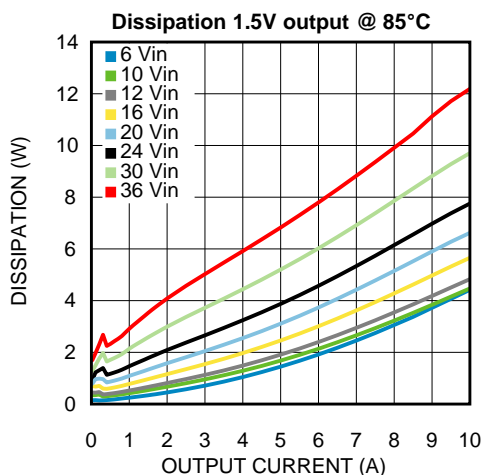

Figure 29.

TYPICAL PERFORMANCE CHARACTERISTICS (continued)

Unless otherwise specified, the following conditions apply: $V_{IN} = 12V$; $C_{IN} = \text{three } \times 10\mu F + 47nF \text{ X7R Ceramic}$; $C_{OUT} = \text{two } \times 330\mu F \text{ Specialty Polymer} + 47 \mu F \text{ Ceramic} + 47nF \text{ Ceramic}$; $C_{FF} = 4.7nF$; $T_{\text{ambient}} = 25^\circ \text{C}$ for waveforms. All indicated temperatures are ambient.

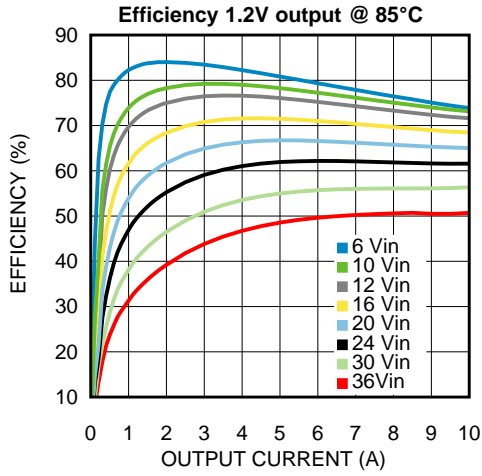

Figure 30.

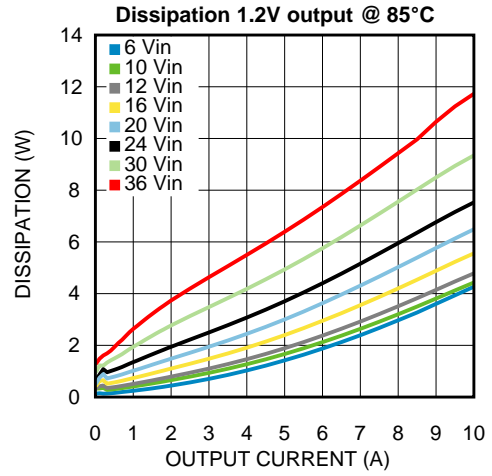

Figure 31.

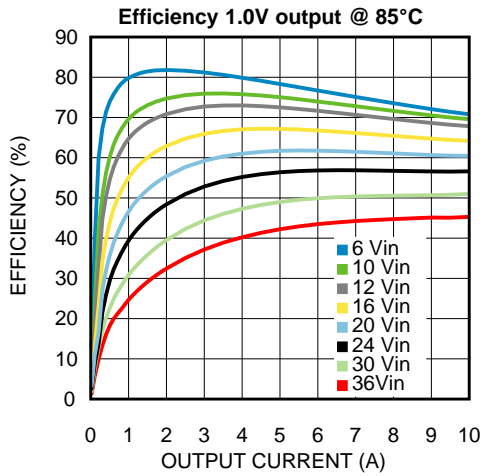

Figure 32.

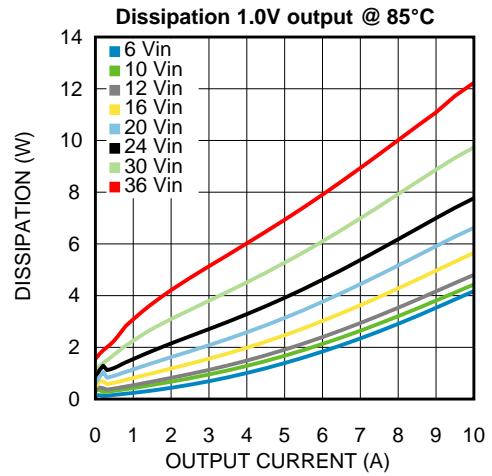

Figure 33.

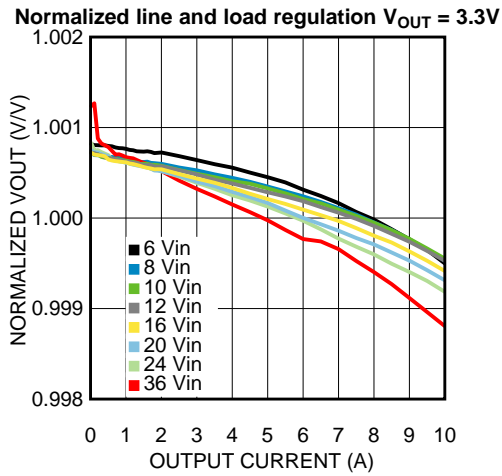

Figure 34.

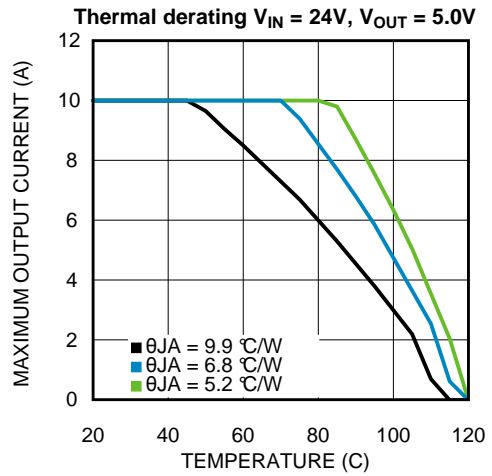

Figure 35.

TYPICAL PERFORMANCE CHARACTERISTICS (continued)

Unless otherwise specified, the following conditions apply: $V_{IN} = 12V$; $C_{IN} = \text{three } \times 10\mu F + 47nF \text{ X7R Ceramic}$; $C_{OUT} = \text{two } \times 330\mu F \text{ Specialty Polymer} + 47 \mu F \text{ Ceramic} + 47nF \text{ Ceramic}$; $C_{FF} = 4.7nF$; $T_{\text{ambient}} = 25^\circ \text{C}$ for waveforms. All indicated temperatures are ambient.

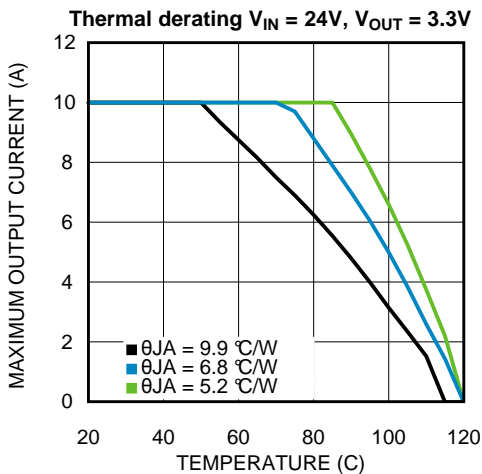

Figure 36.

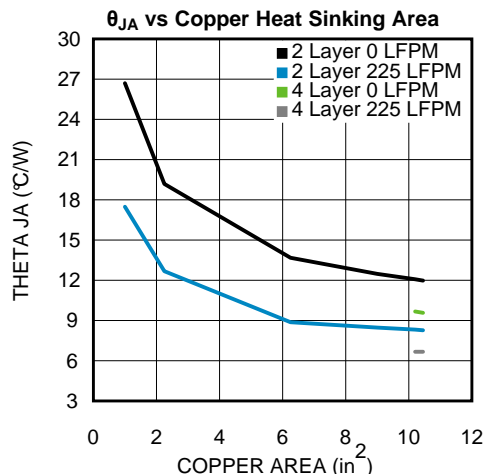
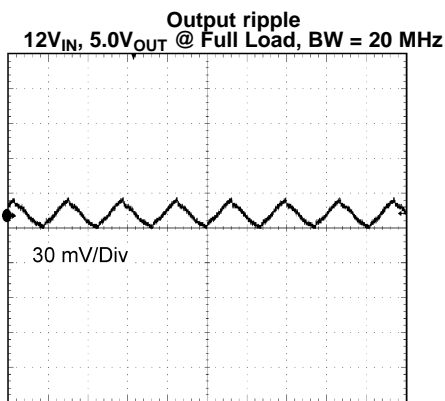
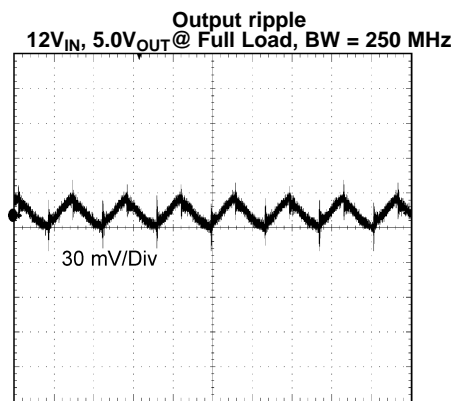

Figure 37.



TIME (2 $\mu s/Div$)
Figure 38.



TIME (2 $\mu s/Div$)
Figure 39.

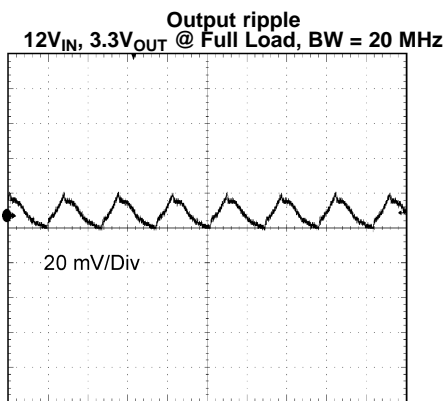

TIME (2 $\mu s/Div$)
Figure 40.

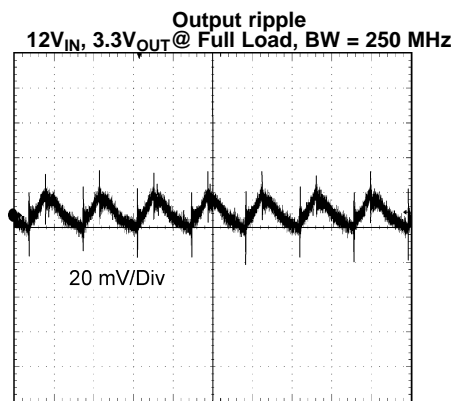

TIME (2 $\mu s/Div$)
Figure 41.

TYPICAL PERFORMANCE CHARACTERISTICS (continued)

Unless otherwise specified, the following conditions apply: $V_{IN} = 12V$; $C_{IN} = \text{three } \times 10\mu F + 47nF \text{ X7R Ceramic}$; $C_{OUT} = \text{two } \times 330\mu F \text{ Specialty Polymer} + 47 \mu F \text{ Ceramic} + 47nF \text{ Ceramic}$; $C_{FF} = 4.7nF$; $T_{\text{ambient}} = 25^\circ \text{C}$ for waveforms. All indicated temperatures are ambient.

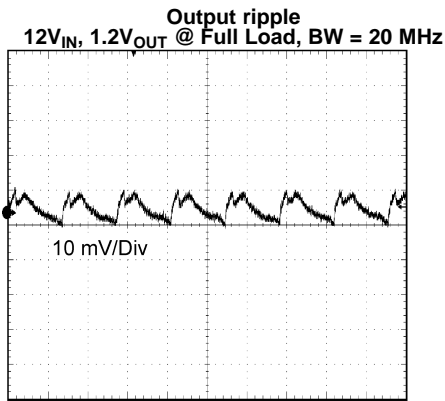

TIME (2 μs /Div)
Figure 42.

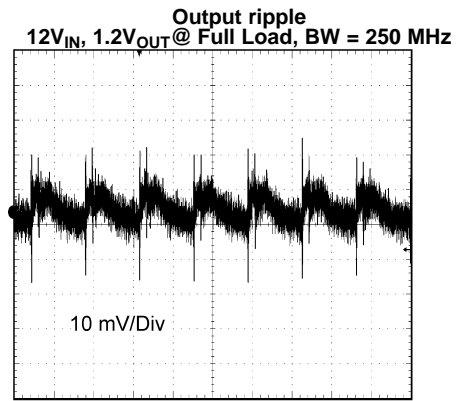

TIME (2 μs /Div)
Figure 43.

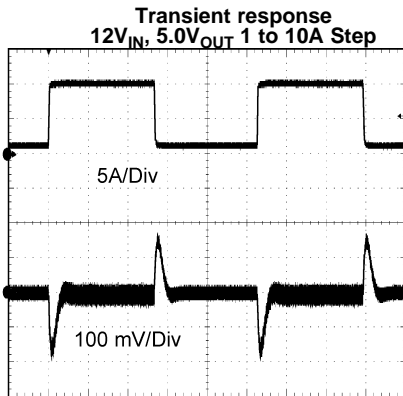

TIME (500 μs /Div)
Figure 44.

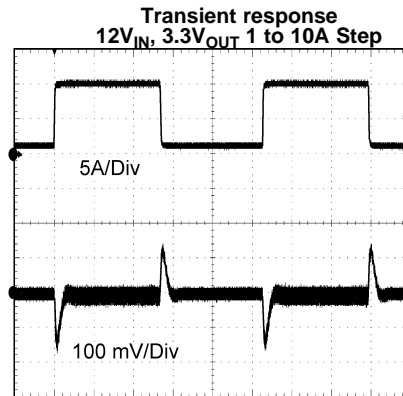

TIME (500 μs /Div)
Figure 45.

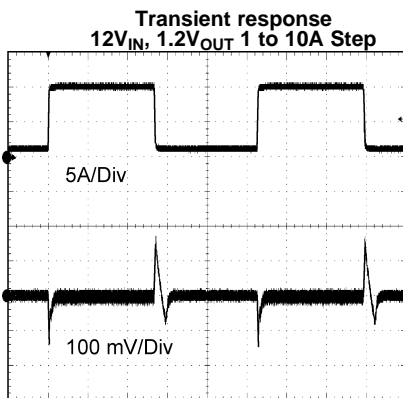

TIME (500 μs /Div)
Figure 46.

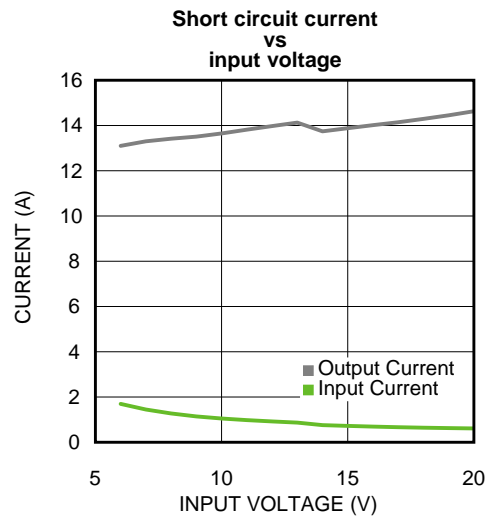

Figure 47.

TYPICAL PERFORMANCE CHARACTERISTICS (continued)

Unless otherwise specified, the following conditions apply: $V_{IN} = 12V$; $C_{IN} = \text{three } \times 10\mu F + 47nF \text{ X7R Ceramic}$; $C_{OUT} = \text{two } \times 330\mu F \text{ Specialty Polymer} + 47 \mu F \text{ Ceramic} + 47nF \text{ Ceramic}$; $C_{FF} = 4.7nF$; $T_{\text{ambient}} = 25^\circ \text{C}$ for waveforms. All indicated temperatures are ambient.

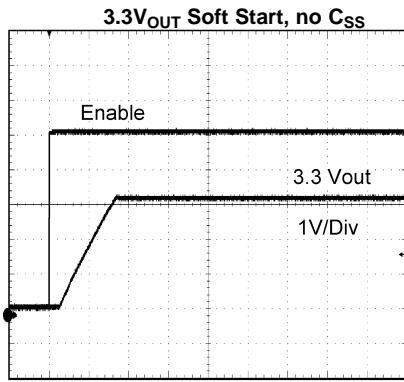

Figure 48.

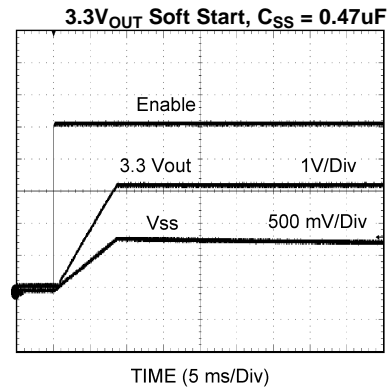
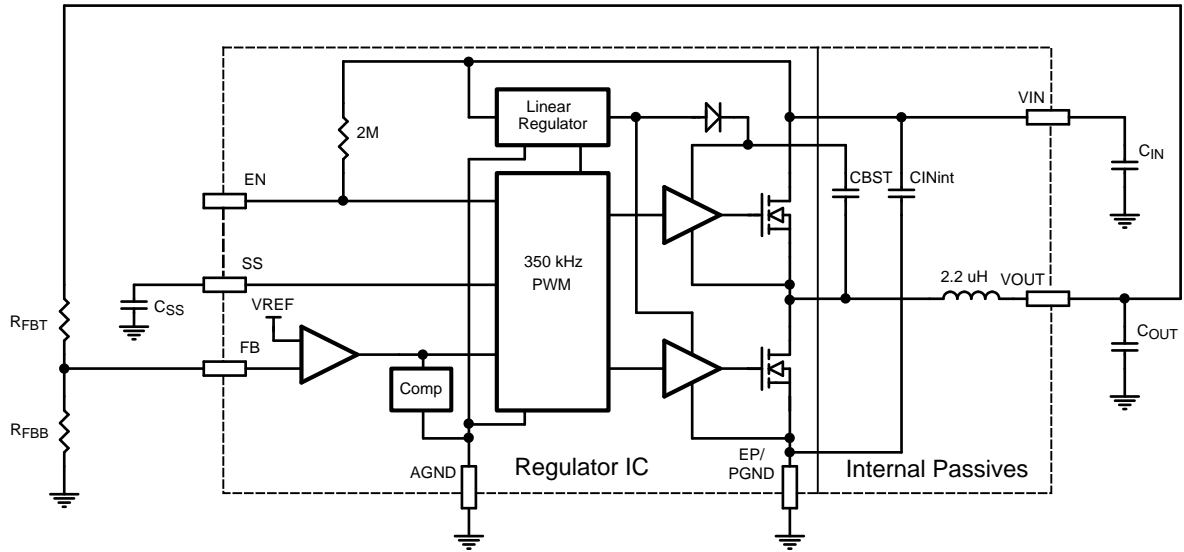

Figure 49.

BLOCK DIAGRAM



DESIGN STEPS FOR THE LMZ13610 APPLICATION

The LMZ13610 is fully supported by WEBENCH which offers: component selection, electrical and thermal simulations. Additionally, there are both evaluation and demonstration boards that may be used as a starting point for design. The following list of steps can be used to manually design the LMZ13610 application.

All references to values refer to the [typical applications schematic](#).

- Select minimum operating V_{IN} with enable divider resistors
- Program V_{OUT} with FB resistor divider selection
- Select C_{OUT}
- Select C_{IN}
- Determine module power dissipation
- Layout PCB for required thermal performance

ENABLE DIVIDER, R_{ENT} , R_{ENB} AND R_{ENH} SELECTION

Internal to the module is a 2 mega ohm pull-up resistor connected from V_{IN} to Enable. For applications not requiring precision under voltage lock out (UVLO), the Enable input may be left open circuit and the internal resistor will always enable the module. In such case, the internal UVLO occurs typically at 4.3V (V_{IN} rising).

In applications with separate supervisory circuits Enable can be directly interfaced to a logic source. In the case of sequencing supplies, the divider is connected to a rail that becomes active earlier in the power-up cycle than the LMZ13610 output rail.

Enable provides a precise 1.274V threshold to allow direct logic drive or connection to a voltage divider from a higher enable voltage such as V_{IN} . Additionally there is 13 μA (typ) of switched offset current allowing programmable hysteresis. See [Figure 50](#).

The function of the enable divider is to allow the designer to choose an input voltage below which the circuit will be disabled. This implements the feature of a programmable UVLO. The two resistors should be chosen based on the following ratio:

$$R_{ENT} / R_{ENB} = (V_{IN\ UVLO} / 1.274V) - 1 \quad (1)$$

The LMZ13610 typical application shows 12.7k Ω for R_{ENB} and 42.2k Ω for R_{ENT} resulting in a rising UVLO of 5.51V. Note that this divider presents 4.62V to the EN input when V_{IN} is raised to 20V. This upper voltage should always be checked, making sure that it never exceeds the Abs Max 5.5V limit for Enable. A 5.1V Zener clamp can be applied in cases where the upper voltage would exceed the EN input's range of operation. The zener clamp is not required if the target application prohibits the maximum Enable input voltage from being exceeded.

Additional enable voltage hysteresis can be added with the inclusion of R_{ENH} . It is possible to select values for R_{ENT} and R_{ENB} such that R_{ENH} is a value of zero allowing it to be omitted from the design.

Rising threshold can be calculated as follows:

$$V_{EN(rising)} = 1.274 (1 + (R_{ENT} || 2\ meg) / R_{ENB}) \quad (2)$$

Whereas the falling threshold level can be calculated using:

$$V_{EN(falling)} = V_{EN(rising)} - 13\ \mu A (R_{ENT} || 2\ meg || R_{ENTB} + R_{ENH}) \quad (3)$$

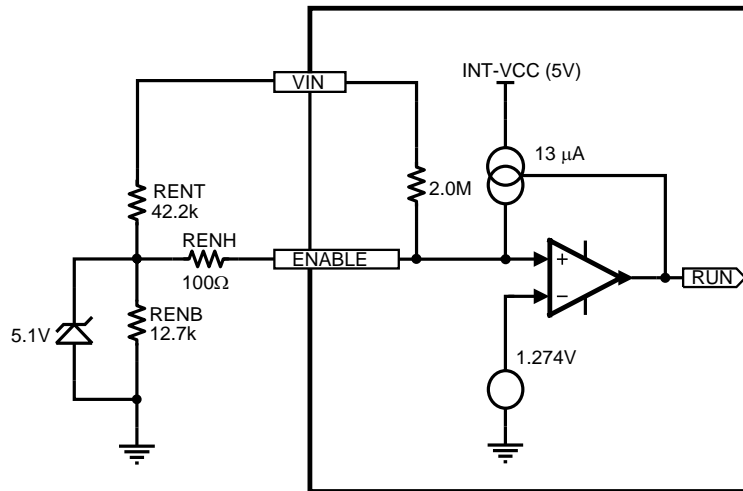

Figure 50. Enable Input Detail

OUTPUT VOLTAGE SELECTION

Output voltage is determined by a divider of two resistors connected between V_{OUT} and AGND. The midpoint of the divider is connected to the FB input.

The regulated output voltage determined by the external divider resistors R_{FBT} and R_{FBB} is:

$$V_{OUT} = 0.795V * (1 + R_{FBT} / R_{FBB}) \quad (4)$$

Rearranging terms; the ratio of the feedback resistors for a desired output voltage is:

$$R_{FBT} / R_{FBB} = (V_{OUT} / 0.795V) - 1 \quad (5)$$

These resistors should generally be chosen from values in the range of 1.0 kΩ to 10.0 kΩ.

For $V_{OUT} = 0.8V$ the FB pin can be connected to the output directly and R_{FBB} can be set to 8.06kΩ to provide minimum output load.

A table of values for R_{FBT} , and R_{FBB} , is included in the [Simplified Application Schematic](#).

SOFT-START CAPACITOR SELECTION

Programmable soft-start permits the regulator to slowly ramp to its steady state operating point after being enabled, thereby reducing current inrush from the input supply and slowing the output voltage rise-time.

Upon turn-on, after all UVLO conditions have been passed, an internal 1.6msec circuit slowly ramps the SS input to implement internal soft start. If 1.6 msec is an adequate turn-on time then the C_{SS} capacitor can be left unpopulated. Longer soft-start periods are achieved by adding an external capacitor to this input.

Soft start duration is given by the formula:

$$t_{SS} = V_{REF} * C_{SS} / I_{SS} = 0.795V * C_{SS} / 50\mu A \quad (6)$$

This equation can be rearranged as follows:

$$C_{SS} = t_{SS} * 50\mu A / 0.795V \quad (7)$$

Using a 0.22μF capacitor results in 3.5 msec typical soft-start duration; and 0.47μF results in 7.5 msec typical. 0.47 μF is a recommended initial value.

As the soft-start input exceeds 0.795V the output of the power stage will be in regulation and the 50 μA current is deactivated. Note that the following conditions will reset the soft-start capacitor by discharging the SS input to ground with an internal current sink.

- The Enable input being pulled low
- A thermal shutdown condition
- V_{IN} falling below 4.3V (TYP) and triggering the V_{CC} UVLO

Note that the stability requirement for minimum output capacitance must always be met.

One recommended output capacitor combination is two 330µF, 15 mOhm ESR tantalum polymer capacitors connected in parallel with a 47 uF 6.3V X5R ceramic. This combination provides excellent performance that may exceed the requirements of certain applications. Additionally some small 47nF ceramic capacitors can be used for high frequency EMI suppression.

C_{IN} SELECTION

The LMZ13610 module contains two internal ceramic input capacitors. Additional input capacitance is required external to the module to handle the input ripple current of the application. The input capacitor can be several capacitors in parallel. This input capacitance should be located in very close proximity to the module. Input capacitor selection is generally directed to satisfy the input ripple current requirements rather than by capacitance value. Input ripple current rating is dictated by [Equation 10](#):

$$I_{CIN-RMS} = I_{OUT} \times \sqrt{D(1-D)}$$

where

- $D \cong V_{OUT} / V_{IN}$ (10)

(As a point of reference, the worst case ripple current will occur when the module is presented with full load current and when $V_{IN} = 2 * V_{OUT}$).

Recommended minimum input capacitance is 30 uF X7R (or X5R) ceramic with a voltage rating at least 25% higher than the maximum applied input voltage for the application. It is also recommended that attention be paid to the voltage and temperature derating of the capacitor selected. It should be noted that ripple current rating of ceramic capacitors may be missing from the capacitor data sheet and you may have to contact the capacitor manufacturer for this parameter.

If the system design requires a certain minimum value of peak-to-peak input ripple voltage (ΔV_{IN}) to be maintained then [Equation 11](#) may be used.

$$C_{IN} \geq \frac{I_{OUT} \times D \times (1 - D)}{f_{SW} \times \Delta V_{IN}} \quad (11)$$

If ΔV_{IN} is 200 mV or 1.66% of V_{IN} for a 12V input to 3.3V output application and $f_{SW} = 350$ kHz then:

$$C_{IN} \geq \frac{10A \times \left(\frac{3.3V}{12V}\right) \times \left(1 - \frac{3.3V}{12V}\right)}{350 \text{ kHz} \times 200 \text{ mV}} \geq 28 \mu\text{F} \quad (12)$$

Additional bulk capacitance with higher ESR may be required to damp any resonant effects of the input capacitance and parasitic inductance of the incoming supply lines. The LMZ13610 typical applications schematic and evaluation board include a 150 µF 50V aluminum capacitor for this function. There are many situations where this capacitor is not necessary.

POWER DISSIPATION AND BOARD THERMAL REQUIREMENTS

When calculating module dissipation use the maximum input voltage and the average output current for the application. Many common operating conditions are provided in the characteristic curves such that less common applications can be derived through interpolation. In all designs, the junction temperature must be kept below the rated maximum of 125°C.

For the design case of $V_{IN} = 12V$, $V_{OUT} = 3.3V$, $I_{OUT} = 10A$, and $T_{A-MAX} = 50^{\circ}C$, the module must see a thermal resistance from case to ambient (θ_{CA}) of less than:

$$\theta_{CA} < \frac{T_{J-MAX} - T_{A-MAX}}{P_{IC_LOSS}} - \theta_{JC} \quad (13)$$

Given the typical thermal resistance from junction to case (θ_{JC}) to be 1.0 °C/W. Use the 85°C power dissipation curves in the [Typical Performance Characteristics](#) section to estimate the P_{IC_LOSS} for the application being designed. In this application it is 5.3W.

$$\theta_{CA} < \frac{125^{\circ}C - 50^{\circ}C}{5.3 W} - 1.0 \frac{^{\circ}C}{W} < 13.15 \frac{^{\circ}C}{W} \quad (14)$$

To reach $\theta_{CA} = 13.15$, the PCB is required to dissipate heat effectively. With no airflow and no external heat-sink, a good estimate of the required board area covered by 2 oz. copper on both the top and bottom metal layers is:

$$\text{Board Area}_{cm^2} \geq \frac{500}{\theta_{CA}} \cdot \frac{^{\circ}C \times cm^2}{W} \quad (15)$$

As a result, approximately 38.02 square cm of 2 oz copper on top and bottom layers is the minimum required area for the example PCB design. This is 6.16 x 6.16 cm (2.42 x 2.42 in) square. The PCB copper heat sink must be connected to the exposed pad. For best performance, use approximately 100, 8mil thermal vias spaced 59 mil (1.5 mm) apart connect the top copper to the bottom copper.

Another way to estimate the temperature rise of a design is using θ_{JA} . An estimate of θ_{JA} for varying heat sinking copper areas and airflows can be found in the [Typical Performance Characteristics](#). If our design required the same operating conditions as before but had 225 LFPM of airflow. We locate the required θ_{JA} of

$$\theta_{JA} < \frac{T_{J-MAX} - T_{A-MAX}}{P_{IC_LOSS}}$$

$$\theta_{JA} < \frac{(125 - 50) ^{\circ}C}{5.3 W} < 14.15 \frac{^{\circ}C}{W} \quad (16)$$

On the Theta JA vs copper heatsinking curve, the copper area required for this application is now only 2 square inches. The airflow reduced the required heat sinking area by a factor of three.

To reduce the heat sinking copper area further, this package is compatible with D3-PAK surface mount heat sinks.

For an example of a high thermal performance PCB layout for SIMPLE SWITCHER power modules, refer to AN-2093 ([SNVA460](#)), AN-2084 ([SNVA456](#)), AN-2125 ([SNVA473](#)), AN-2020 ([SNVA419](#)) and AN-2026 ([SNVA424](#)).

PC BOARD LAYOUT GUIDELINES

PC board layout is an important part of DC-DC converter design. Poor board layout can disrupt the performance of a DC-DC converter and surrounding circuitry by contributing to EMI, ground bounce and resistive voltage drop in the traces. These can send erroneous signals to the DC-DC converter resulting in poor regulation or instability. Good layout can be implemented by following a few simple design rules. A good layout example is shown in [Figure 56](#).

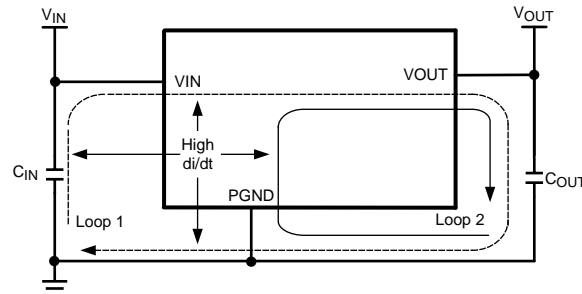

Figure 52. High Current Loops

1. Minimize area of switched current loops.

From an EMI reduction standpoint, it is imperative to minimize the high di/dt paths during PC board layout as shown in [Figure 52](#). The high current loops that do not overlap have high di/dt content that will cause observable high frequency noise on the output pin if the input capacitor (C_{IN}) is placed at a distance away from the LMZ13610. Therefore place C_{IN} as close as possible to the LMZ13610 VIN and PGND exposed pad. This will minimize the high di/dt area and reduce radiated EMI. Additionally, grounding for both the input and output capacitor should consist of a localized top side plane that connects to the PGND exposed pad (EP).

2. Have a single point ground.

The ground connections for the feedback, soft-start, and enable components should be routed to the AGND pin of the device. This prevents any switched or load currents from flowing in the analog ground traces. If not properly handled, poor grounding can result in degraded load regulation or erratic output voltage ripple behavior. Additionally provide a single point ground connection from pin 4 (AGND) to EP/PGND.

3. Minimize trace length to the FB pin.

Both feedback resistors, R_{FBT} and R_{FBB} should be located close to the FB pin. Since the FB node is high impedance, maintain the copper area as small as possible. The traces from R_{FBT} , R_{FBB} should be routed away from the body of the LMZ13610 to minimize possible noise pickup.

4. Make input and output bus connections as wide as possible.

This reduces any voltage drops on the input or output of the converter and maximizes efficiency. To optimize voltage accuracy at the load, ensure that a separate feedback voltage sense trace is made to the load. Doing so will correct for voltage drops and provide optimum output accuracy.

5. Provide adequate device heat-sinking.

Use an array of heat-sinking vias to connect the exposed pad to the ground plane on the bottom PCB layer. If the PCB has multiple copper layers, these thermal vias can also be connected to inner layer heat-spreading ground planes. For best results use a 10 x 10 via array or larger with a minimum via diameter of 8mil thermal vias spaced 46.8mil (1.5 mm). Ensure enough copper area is used for heat-sinking to keep the junction temperature below 125°C.

ADDITIONAL FEATURES

OUTPUT OVER-VOLTAGE PROTECTION

If the voltage at FB is greater than a 0.86V internal reference, the output of the error amplifier is pulled toward ground, causing V_{OUT} to fall.

CURRENT LIMIT

The LMZ13610 is protected by both low side (LS) and high side (HS) current limit circuitry. The LS current limit detection is carried out during the off-time by monitoring the current through the LS synchronous MOSFET. Referring to the [Functional Block Diagram](#), when the top MOSFET is turned off, the inductor current flows through the load, the PGND pin and the internal synchronous MOSFET. If this current exceeds 13A (typical) the current limit comparator disables the start of the next switching period. Switching cycles are prohibited until current drops below the limit. It should also be noted that d.c. current limit is dependent on duty cycle as illustrated in the graph in the [Typical Performance Characteristics](#) section. The HS current limit monitors the current of top side MOSFET. Once HS current limit is detected (16A typical), the HS MOSFET is shutoff immediately, until the next cycle. Exceeding HS current limit causes V_{OUT} to fall. Typical behavior of exceeding LS current limit is that f_{SW} drops to 1/2 of the operating frequency.

THERMAL PROTECTION

The junction temperature of the LMZ13610 should not be allowed to exceed its maximum ratings. Thermal protection is implemented by an internal Thermal Shutdown circuit which activates at 165 °C (typ) causing the device to enter a low power standby state. In this state the main MOSFET remains off causing V_{OUT} to fall, and additionally the C_{SS} capacitor is discharged to ground. Thermal protection helps prevent catastrophic failures for accidental device overheating. When the junction temperature falls back below 150 °C (typ Hyst = 15°C) the SS pin is released, V_{OUT} rises smoothly, and normal operation resumes.

Applications requiring maximum output current especially those at high input voltage may require additional derating at elevated temperatures.

PRE-BIASED STARTUP

The LMZ13610 will properly start up into a pre-biased output. This startup situation is common in multiple rail logic applications where current paths may exist between different power rails during the startup sequence. The following scope capture shows proper behavior in this mode. Trace one is Enable going high. Trace two is 1.8V pre-bias rising to 3.3V. Trace three is the SS voltage with a $C_{SS} = 0.47\mu\text{F}$. Risetime determined by C_{SS} .

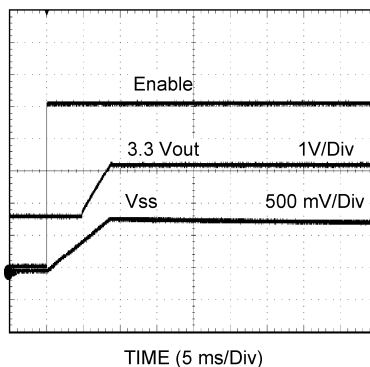

Figure 53. Pre-Biased Startup

DISCONTINUOUS CONDUCTION AND CONTINUOUS CONDUCTION MODES

At light load the regulator will operate in discontinuous conduction mode (DCM). With load currents above the critical conduction point, it will operate in continuous conduction mode (CCM). When operating in DCM, inductor current is maintained to an average value equaling I_{OUT} . In DCM the low-side switch will turn off when the inductor current falls to zero, this causes the inductor current to resonate. Although it is in DCM, the current is allowed to go slightly negative to charge the bootstrap capacitor.

In CCM, current flows through the inductor through the entire switching cycle and never falls to zero during the off-time.

Following is a comparison pair of waveforms showing both the CCM (upper) and DCM operating modes.

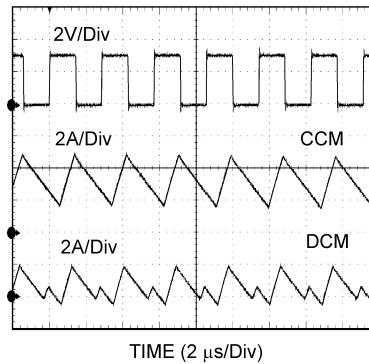

Figure 54. CCM and DCM Operating Modes
 $V_{IN} = 12V$, $V_O = 3.3V$, $I_O = 3A/0.3A$

The approximate formula for determining the DCM/CCM boundary is as follows:

$$I_{DCB} = \frac{(V_{IN} - V_{OUT}) \times D}{2 \times L \times f_{SW}} \quad (17)$$

The inductor internal to the module is 2.2 μH . This value was chosen as a good balance between low and high input voltage applications. The main parameter affected by the inductor is the amplitude of the inductor ripple current (Δi_L). Δi_L can be calculated with:

$$\Delta i_L = \frac{(V_{IN} - V_{OUT}) \times D}{L \times f_{SW}}$$

where

- V_{IN} is the maximum input voltage
 - f_{SW} is typically 359 kHz
- (18)

If the output current I_{OUT} is determined by assuming that $I_{OUT} = I_L$, the higher and lower peak of Δi_L can be determined.

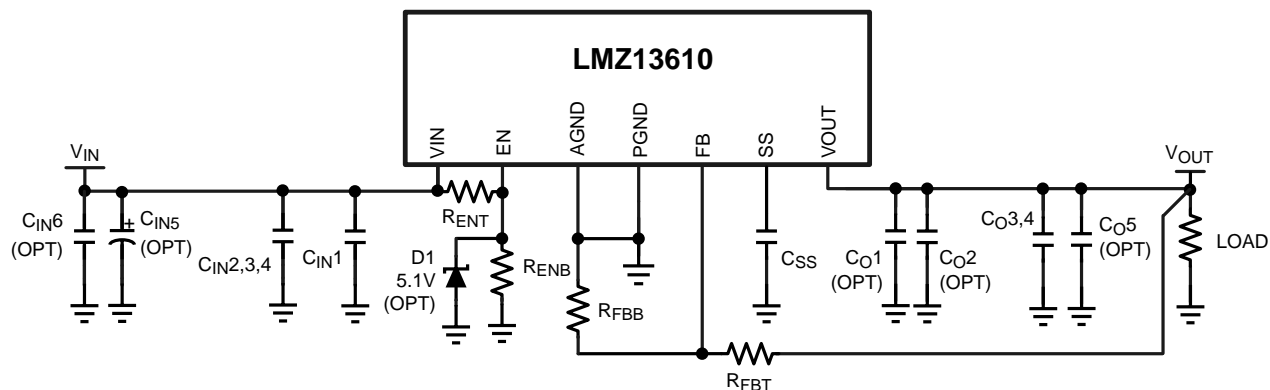
Typical Application Schematic Diagram and BOM

Figure 55.
Table 1. Typical Application Bill of Materials

| Ref Des | Description | Case Size | Manufacturer | Manufacturer P/N |
|--------------------------|-----------------------------------|-------------|-------------------|--------------------|
| U1 | SIMPLE SWITCHER | PFM-11 | Texas Instruments | LMZ13610TZ |
| C _{IN1,6} (OPT) | 0.047 μ F, 50V, X7R | 1206 | Yageo America | CC1206KRX7R9BB473 |
| C _{IN2,3,4} | 10 μ F, 50V, X7R | 1210 | Taiyo Yuden | UMK325BJ106MM-T |
| C _{IN5} (OPT) | CAP, AL, 150 μ F, 50V | Radial G | Panasonic | EEE-FK1H151P |
| C _{O1,5} (OPT) | 0.047 μ F, 50V, X7R | 1206 | Yageo America | CC1206KRX7R9BB473 |
| C _{O2} (OPT) | 47 μ F, 10V, X7R | 1210 | Murata | GRM32ER61A476KE20L |
| C _{O3,4} | 330 μ F, 6.3V, 0.015 ohm | CAPSMT_6_UE | Kemet | T520D337M006ATE015 |
| R _{FBT} | 3.32 k Ω | 0805 | Panasonic | ERJ-6ENF3321V |
| R _{FBB} | 1.07 k Ω | 0805 | Panasonic | ERJ-6ENF1071V |
| R _{ENT} | 42.2 k Ω | 0805 | Panasonic | ERJ-6ENF4222V |
| R _{ENB} | 12.7 k Ω | 0805 | Panasonic | ERJ-6ENF1272V |
| C _{SS} | 0.47 μ F, \pm 10%, X7R, 16V | 0805 | AVX | 0805YC474KAT2A |
| D1 (OPT) | 5.1V, 0.5W | SOD-123 | Diodes Inc. | MMSZ5231BS-7-F |

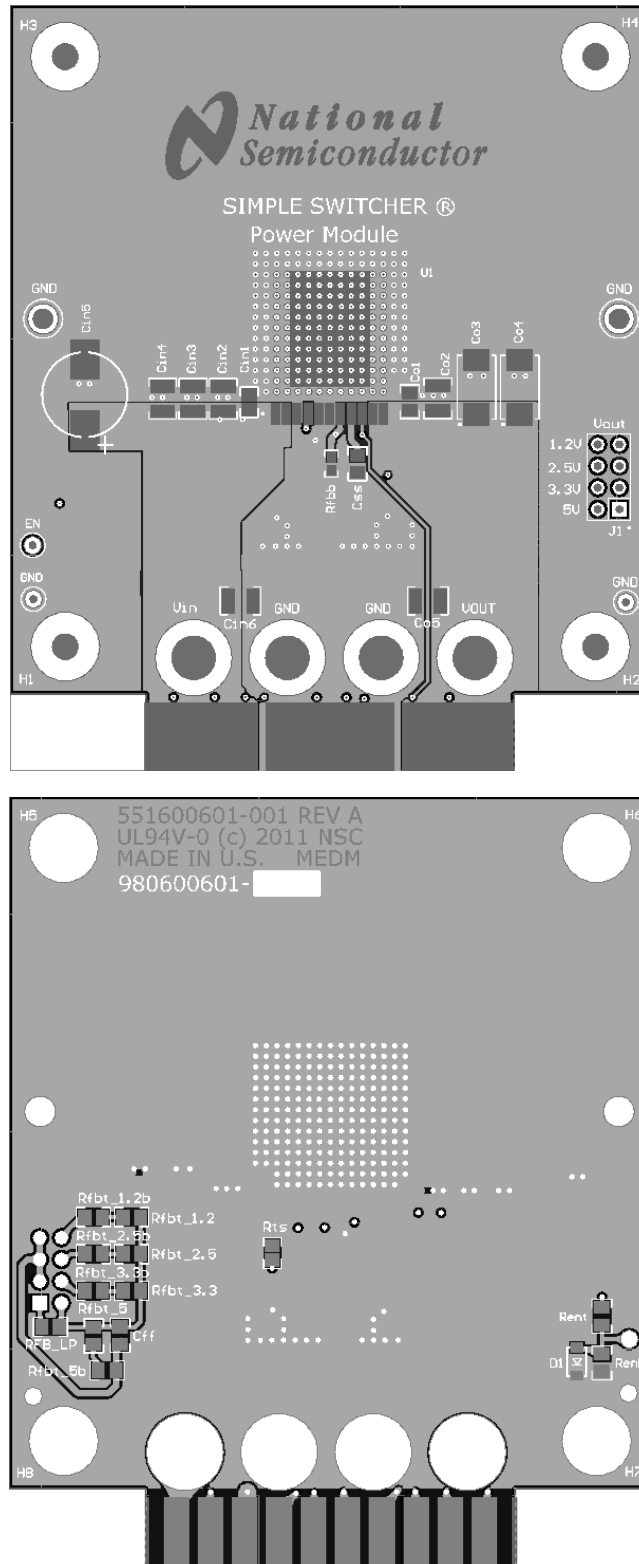

Figure 56. Layout Example

Power Module SMT Guidelines

The recommendations below are for a standard module surface mount assembly

- Land Pattern – Follow the PCB land pattern with either soldermask defined or non-soldermask defined pads
- Stencil Aperture
 - For the exposed die attach pad (DAP), adjust the stencil for approximately 80% coverage of the PCB land pattern
 - For all other I/O pads use a 1:1 ratio between the aperture and the land pattern recommendation
- Solder Paste – Use a standard SAC Alloy such as SAC 305, type 3 or higher
- Stencil Thickness – 0.125 to 0.15mm
- Reflow - Refer to solder paste supplier recommendation and optimized per board size and density
- Maximum number of reflows allowed is one

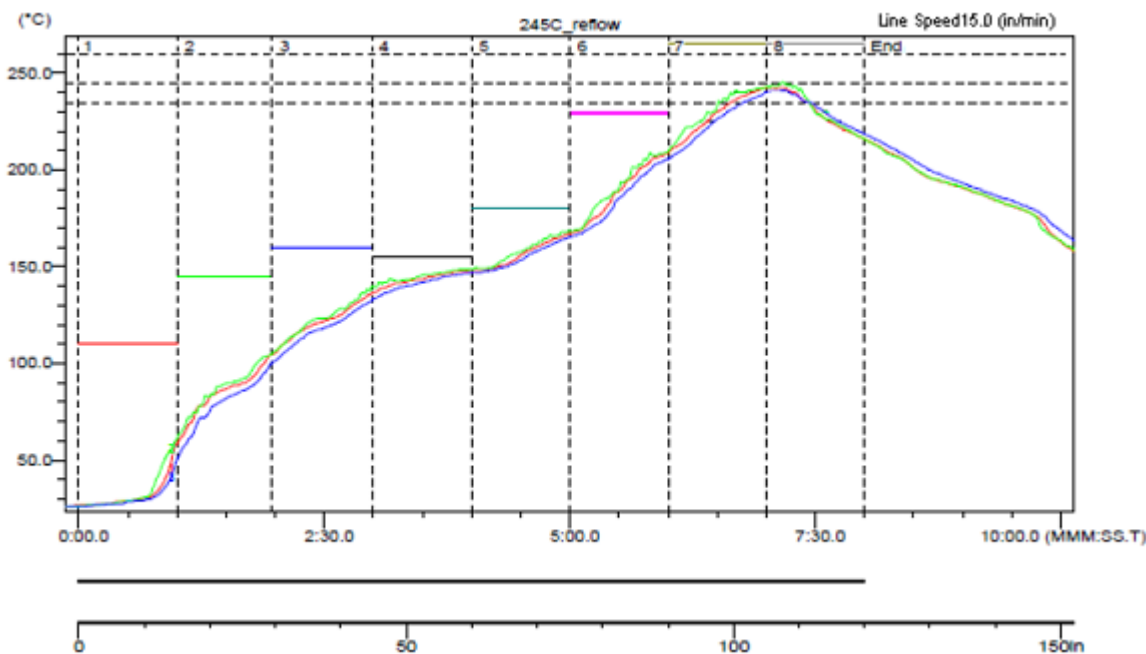

Figure 57. Sample Reflow Profile

Table 2.

| Probe | Max Temp (°C) | Reached Max Temp | Time Above 235°C | Reached 235°C | Time Above 245°C | Reached 245°C | Time Above 260°C | Reached 260°C |
|-------|---------------|------------------|------------------|---------------|------------------|---------------|------------------|---------------|
| #1 | 242.5 | 6.58 | 0.49 | 6.39 | 0.00 | – | 0.00 | – |
| #2 | 242.5 | 7.10 | 0.55 | 6.31 | 0.00 | 7.10 | 0.00 | – |
| #3 | 241.0 | 7.09 | 0.42 | 6.44 | 0.00 | – | 0.00 | – |

REVISION HISTORY

| Changes from Revision D (November 2012) to Revision E | Page |
|---|------|
| • Added Peak Reflow Case Temp = 245°C | 1 |
| • Deleted 12mils | 5 |
| • Changed 12mils | 19 |
| • Changed 12mils | 20 |
| • Added Power Module SMT Guidelines | 25 |

IMPORTANT NOTICE

Texas Instruments Incorporated and its subsidiaries (TI) reserve the right to make corrections, enhancements, improvements and other changes to its semiconductor products and services per JESD46, latest issue, and to discontinue any product or service per JESD48, latest issue. Buyers should obtain the latest relevant information before placing orders and should verify that such information is current and complete. All semiconductor products (also referred to herein as "components") are sold subject to TI's terms and conditions of sale supplied at the time of order acknowledgment.

TI warrants performance of its components to the specifications applicable at the time of sale, in accordance with the warranty in TI's terms and conditions of sale of semiconductor products. Testing and other quality control techniques are used to the extent TI deems necessary to support this warranty. Except where mandated by applicable law, testing of all parameters of each component is not necessarily performed.

TI assumes no liability for applications assistance or the design of Buyers' products. Buyers are responsible for their products and applications using TI components. To minimize the risks associated with Buyers' products and applications, Buyers should provide adequate design and operating safeguards.

TI does not warrant or represent that any license, either express or implied, is granted under any patent right, copyright, mask work right, or other intellectual property right relating to any combination, machine, or process in which TI components or services are used. Information published by TI regarding third-party products or services does not constitute a license to use such products or services or a warranty or endorsement thereof. Use of such information may require a license from a third party under the patents or other intellectual property of the third party, or a license from TI under the patents or other intellectual property of TI.

Reproduction of significant portions of TI information in TI data books or data sheets is permissible only if reproduction is without alteration and is accompanied by all associated warranties, conditions, limitations, and notices. TI is not responsible or liable for such altered documentation. Information of third parties may be subject to additional restrictions.

Resale of TI components or services with statements different from or beyond the parameters stated by TI for that component or service voids all express and any implied warranties for the associated TI component or service and is an unfair and deceptive business practice. TI is not responsible or liable for any such statements.

Buyer acknowledges and agrees that it is solely responsible for compliance with all legal, regulatory and safety-related requirements concerning its products, and any use of TI components in its applications, notwithstanding any applications-related information or support that may be provided by TI. Buyer represents and agrees that it has all the necessary expertise to create and implement safeguards which anticipate dangerous consequences of failures, monitor failures and their consequences, lessen the likelihood of failures that might cause harm and take appropriate remedial actions. Buyer will fully indemnify TI and its representatives against any damages arising out of the use of any TI components in safety-critical applications.

In some cases, TI components may be promoted specifically to facilitate safety-related applications. With such components, TI's goal is to help enable customers to design and create their own end-product solutions that meet applicable functional safety standards and requirements. Nonetheless, such components are subject to these terms.

No TI components are authorized for use in FDA Class III (or similar life-critical medical equipment) unless authorized officers of the parties have executed a special agreement specifically governing such use.

Only those TI components which TI has specifically designated as military grade or "enhanced plastic" are designed and intended for use in military/aerospace applications or environments. Buyer acknowledges and agrees that any military or aerospace use of TI components which have **not** been so designated is solely at the Buyer's risk, and that Buyer is solely responsible for compliance with all legal and regulatory requirements in connection with such use.

TI has specifically designated certain components as meeting ISO/TS16949 requirements, mainly for automotive use. In any case of use of non-designated products, TI will not be responsible for any failure to meet ISO/TS16949.

Products

| | |
|------------------------------|--|
| Audio | www.ti.com/audio |
| Amplifiers | amplifier.ti.com |
| Data Converters | dataconverter.ti.com |
| DLP® Products | www.dlp.com |
| DSP | dsp.ti.com |
| Clocks and Timers | www.ti.com/clocks |
| Interface | interface.ti.com |
| Logic | logic.ti.com |
| Power Mgmt | power.ti.com |
| Microcontrollers | microcontroller.ti.com |
| RFID | www.ti-rfid.com |
| OMAP Applications Processors | www.ti.com/omap |
| Wireless Connectivity | www.ti.com/wirelessconnectivity |

Applications

| | |
|-------------------------------|--|
| Automotive and Transportation | www.ti.com/automotive |
| Communications and Telecom | www.ti.com/communications |
| Computers and Peripherals | www.ti.com/computers |
| Consumer Electronics | www.ti.com/consumer-apps |
| Energy and Lighting | www.ti.com/energy |
| Industrial | www.ti.com/industrial |
| Medical | www.ti.com/medical |
| Security | www.ti.com/security |
| Space, Avionics and Defense | www.ti.com/space-avionics-defense |
| Video and Imaging | www.ti.com/video |

TI E2E Community

e2e.ti.com