

**TERMINAL ASSIGNMENT**

## CMOS Hex Voltage-Level Shifter for TTL-to-CMOS or CMOS-to-CMOS Operation

High-Voltage Types (20-Volt Rating)

**Features:**

- Independence of power-supply sequence considerations— $V_{CC}$  can exceed  $V_{DD}$ ; input signals can exceed both  $V_{CC}$  and  $V_{DD}$
- Up and down level-shifting capability
- Shiftable input threshold for either CMOS or TTL compatibility
- Standardized symmetrical output characteristics
- 100% tested for quiescent current @ 20 V
- Maximum input current of 1  $\mu$ A at 18 V over full package-temperature range; 100 nA at 18 V and 25°C
- 5 V, 10 V, and 15 V parametric ratings
- Meets all requirements of JEDEC Standard No. 13B, "Standard Specifications for Description of 'B' Series CMOS Devices"

■ CD4504B hex voltage level-shifter consists of six circuits which shift input signals from the  $V_{CC}$  logic level to the  $V_{DD}$  logic level. To shift TTL signals to CMOS logic levels, the SELECT input is at the  $V_{CC}$  HIGH logic state. When the SELECT input is at a LOW logic state, each circuit translates signals from one CMOS level to another.

The CD4504B types are supplied in 16-lead hermetic dual-in-line ceramic packages (F3A suffix), 16-lead dual-in-line plastic packages (E suffix), 16-lead small-outline packages (M, M96, and MT suffixes), and 16-lead thin shrink small-outline packages (PW and PWR suffixes).

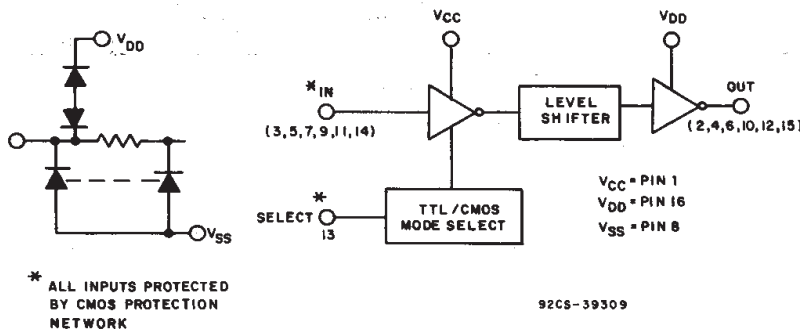

Fig. 1 - Functional diagram for CD4504B.

**MAXIMUM RATINGS, Absolute-Maximum Values:**

**DC SUPPLY-VOLTAGE RANGE, ( $V_{DD}$ )**

Voltages referenced to  $V_{SS}$  Terminal ..... -0.5V to +20V

INPUT VOLTAGE RANGE, ALL INPUTS ..... -0.5V to  $V_{CC}$  +0.5V

DC INPUT CURRENT, ANY ONE INPUT .....  $\pm$ 10mA

**POWER DISSIPATION PER PACKAGE ( $P_D$ ):**

For  $T_A = -55^\circ\text{C}$  to  $+100^\circ\text{C}$  ..... 500mW

For  $T_A = +100^\circ\text{C}$  to  $+125^\circ\text{C}$ : ..... Derate Linearly at 12mW/ $^\circ\text{C}$  to 200mW

**DEVICE DISSIPATION PER OUTPUT TRANSISTOR -**

FOR  $T_A =$  FULL PACKAGE-TEMPERATURE RANGE (All Package Types) ..... 100mW

OPERATING-TEMPERATURE RANGE ( $T_A$ ) .....  $-55^\circ\text{C}$  to  $+125^\circ\text{C}$

STORAGE TEMPERATURE RANGE ( $T_{stg}$ ) .....  $-85^\circ\text{C}$  to  $+150^\circ\text{C}$

**LEAD TEMPERATURE (DURING SOLDERING):**

At distance 1/16  $\pm$  1/32 inch (1.59  $\pm$  0.79mm) from case for 10s max .....  $+265^\circ\text{C}$

3  
COMMERCIAL CMOS  
HIGH VOLTAGE ICs

# CD4504B Types

V<sub>GEN</sub>

## STATIC ELECTRICAL CHARACTERISTICS

CHARACTERISTIC	CONDITIONS				LIMITS AT INDICATED TEMPERATURES (°C)							UNITS	
	V <sub>O</sub> (V)	V <sub>IN</sub> (V)	V <sub>CC</sub> (V)	V <sub>DD</sub> (V)	-55	-40	+85	+125	+25				
									MIN	TYP	MAX		
Quiescent Device Current, I <sub>DD</sub> Max and I <sub>CC</sub> in CMOS-CMOS Mode	—	0,5	5	5	1.5	1.5	1.5	1.5	—	0.02	1.5	mA	
	—	0,10	5	10	2	2	2	2	—	0.02	2		
	—	0,15	5	15	4	4	120	120	—	0.02	4	μA	
	—	0,20	5	20	20	20	600	600	—	0.04	20		
Quiescent Device Current, I <sub>CC</sub> Max TTL-CMOS Mode	—	0,5	5	5	5	5	6	6	—	2.5	5	mA	
	—	0,10	5	10	5	5	6	6	—	2.5	5		
	—	0,15	5	15	5	5	6	6	—	2.5	5		
Output Low (Sink) Current, I <sub>OL</sub> Min	0.4	0.5	—	5	0.64	0.61	0.42	0.36	0.51	1	—	mA	
	0.5	0,10	—	10	1.6	1.5	1.1	0.9	1.3	2.6	—		
	1.5	0,15	—	15	4.2	4	2.8	2.4	3.4	6.8	—		
Output High (Source) Current, I <sub>OH</sub> Min	4.6	0,5	—	5	-0.64	-0.61	-0.42	-0.36	-0.51	-1	—	mA	
	2.5	0,5	—	5	-2	-1.8	-1.3	-1.15	-1.6	-3.2	—		
	9.5	0,10	—	10	-1.6	-1.5	-1.1	-0.9	-1.3	-2.6	—		
	13.5	0,15	—	15	-4.2	-4	-2.8	-2.4	-3.4	-6.8	—		
Output Voltage: Low-Level, V <sub>OL</sub> Max	—	0,5	—	5	0.05				—	0	0.05	V	
	—	0,10	—	10	0.05				—	0	0.05		
	—	0,15	—	15	0.05				—	0	0.05		
Output Voltage: High-Level, V <sub>OH</sub> Min	—	0,5	—	5	4.95				4.95	5	—	V	
	—	0,10	—	10	9.95				9.95	10	—		
	—	0,15	—	15	14.95				14.95	15	—		
Input Low Voltage, V <sub>IL</sub> Max Note 1	TTL-CMOS	1	—	5	10	0.8				—	—	0.8	V
	TTL-CMOS	1	—	5	15	0.8				—	—	0.8	
	CMOS-CMOS	1	—	5	10	1.5				—	—	1.5	
	CMOS-CMOS	1.5	—	5	15	1.5				—	—	1.5	
	CMOS-CMOS	1.5	—	10	15	3				—	—	3	
Input High Voltage, V <sub>IH</sub> Min Note 1	TTL-CMOS	9	—	5	10	2				2	—	—	V
	TTL-CMOS	13.5	—	5	15	2				2	—	—	
	CMOS-CMOS	9	—	5	10	3.5				3.5	—	—	
	CMOS-CMOS	13.5	—	5	15	3.5				3.5	—	—	
	CMOS-CMOS	13.5	—	10	15	7				7	—	—	
Input Current, I <sub>IN</sub> Max	—	0,18	—	18	±0.1	±0.1	±1	±1	—	±10 <sup>-5</sup>	±0.1	μA	

Note 1: Applies to the 6 input signals. For mode control (P13), only the CMOS-CMOS ratings apply.

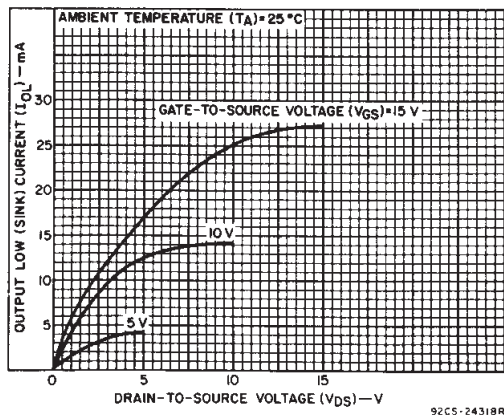

Fig. 2 - Typical output low (sink) current characteristics.

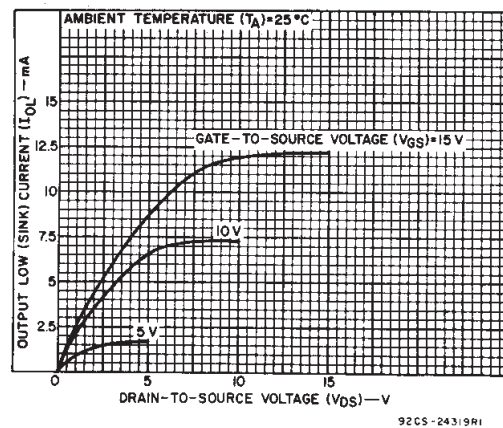
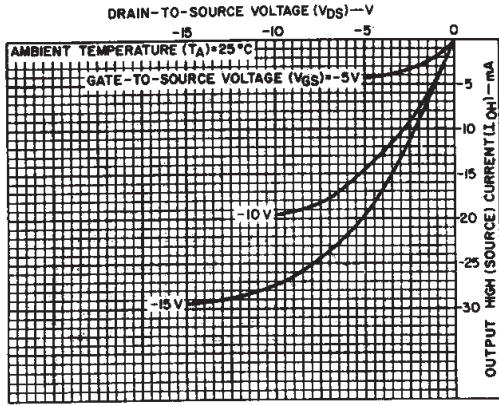

Fig. 3 - Minimum output low (sink) current characteristics.

# CD4504B Types



92CS-24320R3

Fig. 4 - Typical output high (source) current characteristics.

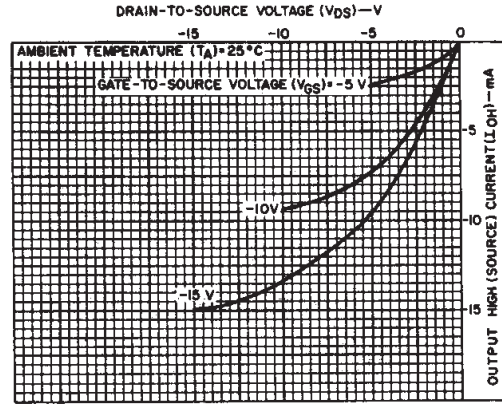

92CS-24321R2

Fig. 5 - Minimum output high (source) current characteristics.

## RECOMMENDED OPERATING CONDITIONS

For maximum reliability, nominal operating conditions should be selected so that operation is always within the following ranges:

CHARACTERISTIC	V <sub>DD</sub> (V)	LIMITS		UNITS
		Min.	Max.	
Supply-Voltage Range (For T <sub>A</sub> = Full Package-Temperature Range)	—	5	18	V

## DYNAMIC ELECTRICAL CHARACTERISTICS, At T<sub>A</sub> = 25°C; Input t<sub>r</sub>, t<sub>f</sub> = 20 ns, C<sub>L</sub> = 50 pF, R<sub>L</sub> = 200 Ω

CHARACTERISTIC	SHIFTING MODE	V <sub>CC</sub> (V)	V <sub>DD</sub> (V)	LIMITS		UNITS
				TYP.	MAX.	
Propagation Delay: High-to-Low, t <sub>PHL</sub>	TTL to CMOS V <sub>DD</sub> > V <sub>CC</sub>	5	10	140	280	ns
	CMOS to CMOS V <sub>DD</sub> > V <sub>CC</sub>	5	15	140	280	
	CMOS to CMOS V <sub>CC</sub> > V <sub>DD</sub>	5	10	120	240	
		5	15	120	240	
		10	15	70	140	
		10	5	275	550	
		15	5	275	550	
		15	10	70	140	
Low-to-High, t <sub>PLH</sub>	TTL to CMOS V <sub>DD</sub> > V <sub>CC</sub>	5	10	140	280	ns
	CMOS to CMOS V <sub>DD</sub> > V <sub>CC</sub>	5	15	140	280	
	CMOS to CMOS V <sub>CC</sub> > V <sub>DD</sub>	5	10	120	240	
		5	15	120	240	
		10	15	70	140	
		10	5	200	400	
		15	5	200	400	
		15	10	60	120	
Transition Time, t <sub>THL</sub> , t <sub>TLH</sub>	All Modes		5	100	200	ns
			10	50	100	
			15	40	80	
Input Capacitance, C <sub>IN</sub>	Any Input			5	7.5	pF

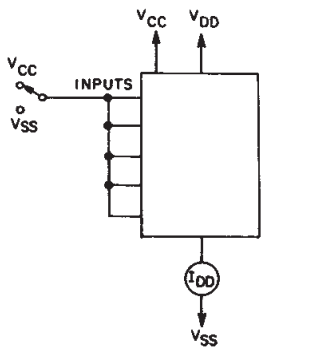

92CS-29452

Fig. 6 - Quiescent device current.

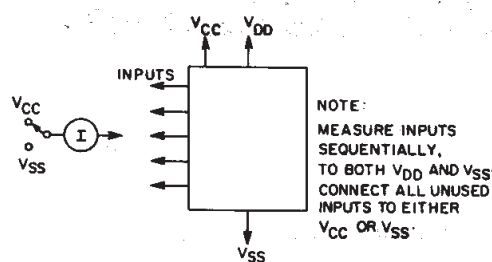

92CS-29454

Fig. 7 - Input current.

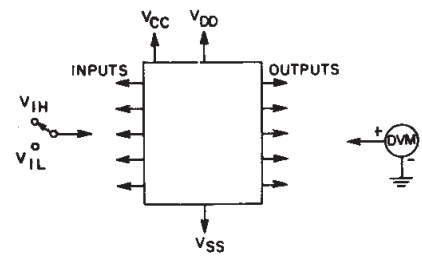

NOTE:  
TEST ANY COMBINATION  
OF INPUTS

92CS-29453

Fig. 8 - Input voltage.

3  
COMMERCIAL CMOS  
HIGH VOLTAGE ICs

# CD4504B Types

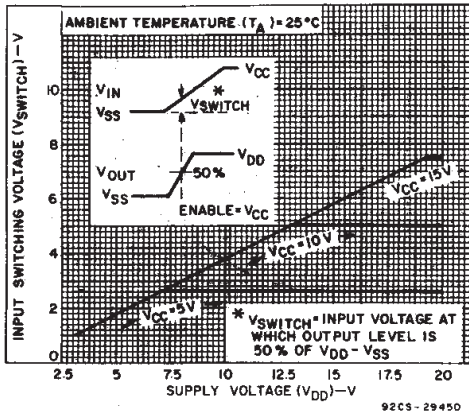

Fig. 9 - Typical input switching as a function of high-level supply voltage. (SELECT at  $V_{CC}$ -CMOS mode).

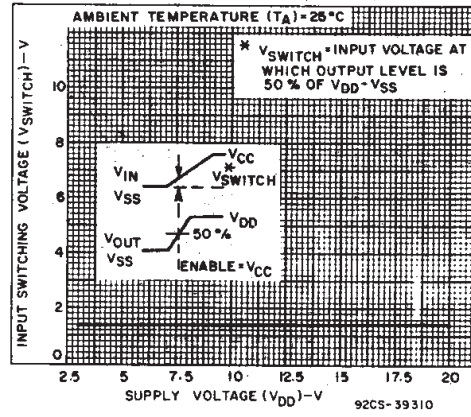

Fig. 10 - Typical input switching as a function of high-level supply voltage (SELECT at  $V_{SS}$ -TTL mode).

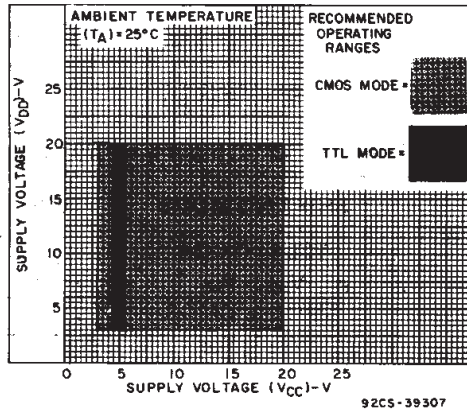
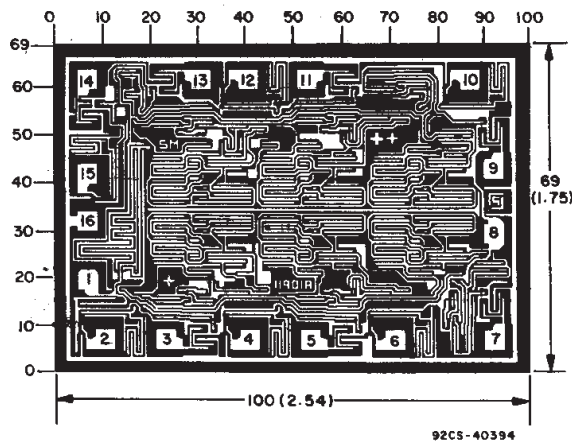

Fig. 11 - High-level supply voltage vs. low-level supply voltage.



Dimensions in parentheses are in millimeters and are derived from the basic inch dimensions as indicated. Grid graduations are in mils ( $10^{-3}$  inch).

Dimensions and pad layout for CD4504BH.

PACKAGING INFORMATION

Orderable Device	Status <sup>(1)</sup>	Package Type	Package Drawing	Pins	Package Qty	Eco Plan <sup>(2)</sup>	Lead/Ball Finish	MSL Peak Temp <sup>(3)</sup>
CD4504BE	ACTIVE	PDIP	N	16	25	Pb-Free (RoHS)	CU NIPDAU	N / A for Pkg Type
CD4504BEE4	ACTIVE	PDIP	N	16	25	Pb-Free (RoHS)	CU NIPDAU	N / A for Pkg Type
CD4504BF3A	ACTIVE	CDIP	J	16	1	TBD	A42 SNPB	N / A for Pkg Type
CD4504BM	ACTIVE	SOIC	D	16	40	Green (RoHS & no Sb/Br)	CU NIPDAU	Level-1-260C-UNLIM
CD4504BM96	ACTIVE	SOIC	D	16	2500	Green (RoHS & no Sb/Br)	CU NIPDAU	Level-1-260C-UNLIM
CD4504BM96E4	ACTIVE	SOIC	D	16	2500	Green (RoHS & no Sb/Br)	CU NIPDAU	Level-1-260C-UNLIM
CD4504BME4	ACTIVE	SOIC	D	16	40	Green (RoHS & no Sb/Br)	CU NIPDAU	Level-1-260C-UNLIM
CD4504BMT	ACTIVE	SOIC	D	16	250	Green (RoHS & no Sb/Br)	CU NIPDAU	Level-1-260C-UNLIM
CD4504BMTE4	ACTIVE	SOIC	D	16	250	Green (RoHS & no Sb/Br)	CU NIPDAU	Level-1-260C-UNLIM
CD4504BPW	ACTIVE	TSSOP	PW	16	90	Green (RoHS & no Sb/Br)	CU NIPDAU	Level-1-260C-UNLIM
CD4504BPWE4	ACTIVE	TSSOP	PW	16	90	Green (RoHS & no Sb/Br)	CU NIPDAU	Level-1-260C-UNLIM
CD4504BPWR	ACTIVE	TSSOP	PW	16	2000	Green (RoHS & no Sb/Br)	CU NIPDAU	Level-1-260C-UNLIM
CD4504BPWRE4	ACTIVE	TSSOP	PW	16	2000	Green (RoHS & no Sb/Br)	CU NIPDAU	Level-1-260C-UNLIM

<sup>(1)</sup> The marketing status values are defined as follows:

**ACTIVE:** Product device recommended for new designs.

**LIFEBUY:** TI has announced that the device will be discontinued, and a lifetime-buy period is in effect.

**NRND:** Not recommended for new designs. Device is in production to support existing customers, but TI does not recommend using this part in a new design.

**PREVIEW:** Device has been announced but is not in production. Samples may or may not be available.

**OBSOLETE:** TI has discontinued the production of the device.

<sup>(2)</sup> Eco Plan - The planned eco-friendly classification: Pb-Free (RoHS), Pb-Free (RoHS Exempt), or Green (RoHS & no Sb/Br) - please check <http://www.ti.com/productcontent> for the latest availability information and additional product content details.

**TBD:** The Pb-Free/Green conversion plan has not been defined.

**Pb-Free (RoHS):** TI's terms "Lead-Free" or "Pb-Free" mean semiconductor products that are compatible with the current RoHS requirements for all 6 substances, including the requirement that lead not exceed 0.1% by weight in homogeneous materials. Where designed to be soldered at high temperatures, TI Pb-Free products are suitable for use in specified lead-free processes.

**Pb-Free (RoHS Exempt):** This component has a RoHS exemption for either 1) lead-based flip-chip solder bumps used between the die and package, or 2) lead-based die adhesive used between the die and leadframe. The component is otherwise considered Pb-Free (RoHS compatible) as defined above.

**Green (RoHS & no Sb/Br):** TI defines "Green" to mean Pb-Free (RoHS compatible), and free of Bromine (Br) and Antimony (Sb) based flame retardants (Br or Sb do not exceed 0.1% by weight in homogeneous material)

<sup>(3)</sup> MSL, Peak Temp. -- The Moisture Sensitivity Level rating according to the JEDEC industry standard classifications, and peak solder temperature.

**Important Information and Disclaimer:**The information provided on this page represents TI's knowledge and belief as of the date that it is provided. TI bases its knowledge and belief on information provided by third parties, and makes no representation or warranty as to the accuracy of such information. Efforts are underway to better integrate information from third parties. TI has taken and continues to take reasonable steps to provide representative and accurate information but may not have conducted destructive testing or chemical analysis on incoming materials and chemicals. TI and TI suppliers consider certain information to be proprietary, and thus CAS numbers and other limited

information may not be available for release.

In no event shall TI's liability arising out of such information exceed the total purchase price of the TI part(s) at issue in this document sold by TI to Customer on an annual basis.

J (R-GDIP-T\*\*)

14 LEADS SHOWN

CERAMIC DUAL IN-LINE PACKAGE



DIM \ PINS **	14	16	18	20
A	0.300 (7,62) BSC	0.300 (7,62) BSC	0.300 (7,62) BSC	0.300 (7,62) BSC
B MAX	0.785 (19,94)	.840 (21,34)	0.960 (24,38)	1.060 (26,92)
B MIN	—	—	—	—
C MAX	0.300 (7,62)	0.300 (7,62)	0.310 (7,87)	0.300 (7,62)
C MIN	0.245 (6,22)	0.245 (6,22)	0.220 (5,59)	0.245 (6,22)



4040083/F 03/03

- NOTES:
- A. All linear dimensions are in inches (millimeters).
  - B. This drawing is subject to change without notice.
  - C. This package is hermetically sealed with a ceramic lid using glass frit.
  - D. Index point is provided on cap for terminal identification only on press ceramic glass frit seal only.
  - E. Falls within MIL STD 1835 GDIP1-T14, GDIP1-T16, GDIP1-T18 and GDIP1-T20.



D (R-PDSO-G16)

PLASTIC SMALL-OUTLINE PACKAGE



- NOTES:
- A. All linear dimensions are in inches (millimeters).
  - B. This drawing is subject to change without notice.
  - C. Body dimensions do not include mold flash or protrusion not to exceed 0.006 (0,15).
  - D. Falls within JEDEC MS-012 variation AC.

PW (R-PDSO-G\*\*)

PLASTIC SMALL-OUTLINE PACKAGE

14 PINS SHOWN



4040064/F 01/97

- NOTES: A. All linear dimensions are in millimeters.  
 B. This drawing is subject to change without notice.  
 C. Body dimensions do not include mold flash or protrusion not to exceed 0,15.  
 D. Falls within JEDEC MO-153

## IMPORTANT NOTICE

Texas Instruments Incorporated and its subsidiaries (TI) reserve the right to make corrections, modifications, enhancements, improvements, and other changes to its products and services at any time and to discontinue any product or service without notice. Customers should obtain the latest relevant information before placing orders and should verify that such information is current and complete. All products are sold subject to TI's terms and conditions of sale supplied at the time of order acknowledgment.

TI warrants performance of its hardware products to the specifications applicable at the time of sale in accordance with TI's standard warranty. Testing and other quality control techniques are used to the extent TI deems necessary to support this warranty. Except where mandated by government requirements, testing of all parameters of each product is not necessarily performed.

TI assumes no liability for applications assistance or customer product design. Customers are responsible for their products and applications using TI components. To minimize the risks associated with customer products and applications, customers should provide adequate design and operating safeguards.

TI does not warrant or represent that any license, either express or implied, is granted under any TI patent right, copyright, mask work right, or other TI intellectual property right relating to any combination, machine, or process in which TI products or services are used. Information published by TI regarding third-party products or services does not constitute a license from TI to use such products or services or a warranty or endorsement thereof. Use of such information may require a license from a third party under the patents or other intellectual property of the third party, or a license from TI under the patents or other intellectual property of TI.

Reproduction of information in TI data books or data sheets is permissible only if reproduction is without alteration and is accompanied by all associated warranties, conditions, limitations, and notices. Reproduction of this information with alteration is an unfair and deceptive business practice. TI is not responsible or liable for such altered documentation.

Resale of TI products or services with statements different from or beyond the parameters stated by TI for that product or service voids all express and any implied warranties for the associated TI product or service and is an unfair and deceptive business practice. TI is not responsible or liable for any such statements.

Following are URLs where you can obtain information on other Texas Instruments products and application solutions:

<b>Products</b>		<b>Applications</b>	
Amplifiers	<a href="http://amplifier.ti.com">amplifier.ti.com</a>	Audio	<a href="http://www.ti.com/audio">www.ti.com/audio</a>
Data Converters	<a href="http://dataconverter.ti.com">dataconverter.ti.com</a>	Automotive	<a href="http://www.ti.com/automotive">www.ti.com/automotive</a>
DSP	<a href="http://dsp.ti.com">dsp.ti.com</a>	Broadband	<a href="http://www.ti.com/broadband">www.ti.com/broadband</a>
Interface	<a href="http://interface.ti.com">interface.ti.com</a>	Digital Control	<a href="http://www.ti.com/digitalcontrol">www.ti.com/digitalcontrol</a>
Logic	<a href="http://logic.ti.com">logic.ti.com</a>	Military	<a href="http://www.ti.com/military">www.ti.com/military</a>
Power Mgmt	<a href="http://power.ti.com">power.ti.com</a>	Optical Networking	<a href="http://www.ti.com/opticalnetwork">www.ti.com/opticalnetwork</a>
Microcontrollers	<a href="http://microcontroller.ti.com">microcontroller.ti.com</a>	Security	<a href="http://www.ti.com/security">www.ti.com/security</a>
Low Power Wireless	<a href="http://www.ti.com/lpw">www.ti.com/lpw</a>	Telephony	<a href="http://www.ti.com/telephony">www.ti.com/telephony</a>
		Video & Imaging	<a href="http://www.ti.com/video">www.ti.com/video</a>
		Wireless	<a href="http://www.ti.com/wireless">www.ti.com/wireless</a>

Mailing Address: Texas Instruments  
Post Office Box 655303 Dallas, Texas 75265