

LV24EVK01

Channel Link II Ser/Des

Evaluation Kit

Rev 0.3
Aug, 2010

General Description

The LV24EVK01 is designed to allow for easy evaluation of the DS92LV2421 and DS92LV2422 Channel Link II Ser/Des. This kit allows for 2 basic methods of evaluation:

- 1) Users may apply parallel clock and data, and evaluate the power, jitter and cable performance of the Ser/Des. Or,
- 2) Apply only a parallel clock and enable BIST mode. This allows the user to easily evaluate the serial link and check device feature functionality such as transmit de-emphasis, receive equalization, SSCG, etc.

The LV24EVK01 boards uses USB connectors as the serial Channel Link II inputs/outputs. SMA connectors can also be attached and configured for serial input/output if other types of the cable are desired.

Features

- 10 – 75 MHz support for 240 Mbps – 1.8 Gbps application payload (280 Mbps to 2.1 Gbps Serial Link)
- LVCMOS parallel interface: 24-bit data + 3 low speed control + clock
- RGB888 + VS, HS, DE serialized to 1 pair
- AC Coupled STP Interconnect up to 10 meters in length
- Selectable output VOD, adjustable de-emphasis and receive equalization
- Integrated serial terminations
- @ Speed link BIST Mode and reporting pin
- Optional I2C compatible Serial Control Bus
- Power down mode minimizes power dissipation
- Randomized, DC-balanced and Scrambled data stream
- >8 kV HBM
- Backward compatible mode for operation with older generation devices

Applications

- Industrial Displays
- Machine Vision
- Medical Imaging

Ordering Information

PART: LV24EVK01

Demo boards:

Tx: DS92LV2421-EVK

Rx: DS92LV2422-EVK

national.com

1



Typical Application Configuration

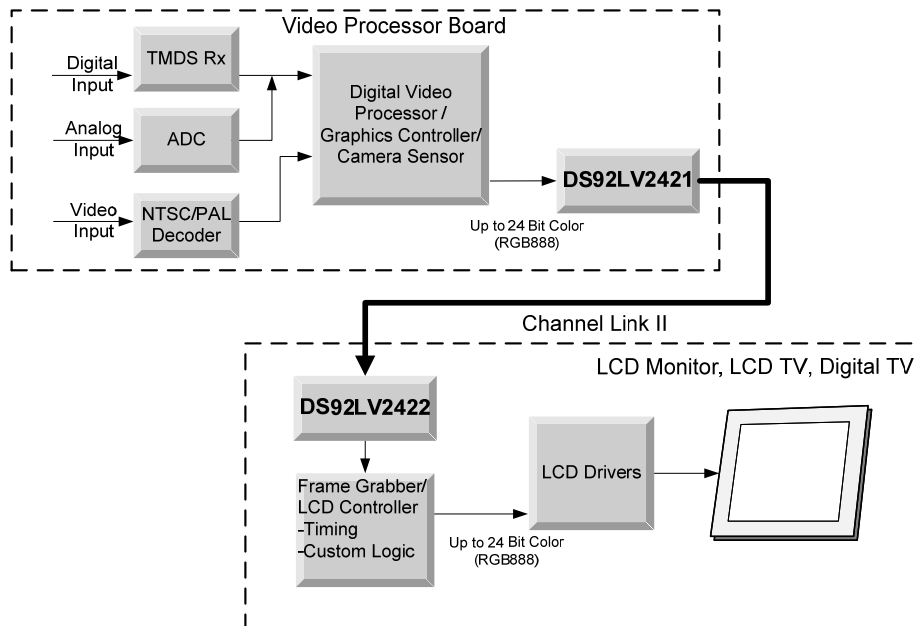

Quick Start Guide:

DS92LV2421 Tx Board:

1. Connect 3.3V DC power to the left header pin of JP1 and ground to the right header pin of JP1 of the board. Connect 1.8V DC power to J3 and ground to J4. By default JP2 is configured such that VDDIO = 3.3 V.
2. Attach the USB cable to the TX board (DS92LV2421) output and to an RX board (DS92LV2422 supplied) input. The default cable connector on the TX board is P3, which is mounted to the bottom of the evaluation board.
3. Attach parallel clock and data to the TX board at connector J1. This is typically done with a flat ribbon cable (not supplied).
4. Jumpers and switches have been configured at the factory; they should not require any changes for immediate operation of the board. See text on Configuration Settings and datasheet for more details.

DS92LV2422 Rx Board

5. Connect 3.3V DC power to the left header pin of JP1 and ground to the right header pin JP1. Connect 1.8V DC power to J4 and ground to J5.
6. Attach the USB cable to the RX board (DS92LV2422) input from a TX board (DS92LV2421) output. The default cable connector on the RX board is J2.
7. Attach the clock and data outputs to the desired test equipment or other external hardware. This is typically done with a flat ribbon cable (not supplied).

Jumpers and switches have been configured at the factory; they should not require any changes for immediate operation of the board. See text on Configuration Settings and datasheet for more details.

Tx Board Configuration Settings

Component	Name	Function
Power Connections		
J2	5V DC	Optional 5V DC Power Jack.
J3	1.8V DC	1.8V VDD Power.
JP1	3.3V DC	3.3V VDD Power (left header pin) and Ground (right header pin)
J4	VSS	Ground.
JP2	VDDI	Connect to 3.3V for 3.3V input logic levels and I2C interface. Connect to 1.8V for 1.8V input logic levels and no I2C.
JP18	VDDL	Always connect to 1.8V.
JP23	VDDP	Always connect to 1.8V.
JP24	VDDHS	Always connect to 1.8V.
Input and Output Connections		
J1	28 position wall header	LVC MOS parallel clock and data input.
J7 and J8	SMA Connectors	Channel Link II output. (When using these connectors, R49 and R50 should be placed with 0Ω resistors, the traces to the P1 should be cut).
P3	USB Connector	Channel Link II output.
JP25 and JP26	Power Wire in USB cable through P3	Connect to VSS is recommended.
Control Connections		
SW1: 7	RFB	Set to "L" to strobe the input data on the falling clock edge. Set to "H" to strobe the input data on the rising clock edge.
SW1: 6	PDB	Set to "L" for the power down mode. Set to "H" for the normal operation.
SW1: 5	CONFIG0	Set to "L" to interface with a DS82LV2422 or DS92LV0422. See datasheet for reverse compatibility mode information
SW1: 4	CONFIG1	Set to "L" to interface with a DS82LV2422 or DS92LV0422. See datasheet for reverse compatibility mode information
SW1: 3	BISTEN	Set to "H" for the BIST enable mode. Set to "L" for normal operation. See datasheet for detail information.
SW1: 2	VODSEL	Connect to "L" for low output VOD swing. Connect to "H" for high output VOD swing. See datasheet for more information.
SW1: 1	RES2	Keep RES2 set to "L"
JP10 and VR4	ID[x]	Connect JP19 to VSS to have the default device PHY address (h'EC). Connect JP19 to VR4; then adjust VR4 value to select desired device PHY address. See datasheet for detail information.
JP3 and J6	I2C Interface	Connect JP3 if the I2C power is not supplied on J6. Otherwise, leave it unconnected.

Tx Board Bill of Materials

Item	Qty	Reference	Part	MFR	MFR Part#	Digi-Key Part#
1	2	C1,C15	2.2uF	KEMET	T491B225K020AT	399-3714-1-ND
2	2	C16,C2	0.1uF	KEMET	C1206C104K5RACTU	399-1249-1-ND
3	4	C3,C4,C8,C9	10uF_open	nichicon	F931C106MBA_open	493-2365-1-ND_open
4	2	C5,C6	0.1uF	Panasonic	ECJ-1VB1H104K	PCC2398CT-ND
5	7	C7,C14,C20,C23,C30	0.1uF	Panasonic	ECJ-1VB1E104K	PCC2277CT-ND
6	2	C10,C13	22uF	nichicon	F931E226MNC	493-2391-1-ND
7	2	C11,C12	5pF	Panasonic	ECJ-ZEC1E050C	PCC2107CT-ND
8	6	C17,C18,C21,C31,C32,C33	22uF	Kemet	T494B226M016AT	399-3835-1-ND
9	5	C29	0.01uF	KEMET	C0603C103K1RACTU	399-3189-1-ND
10	1	C22	0.1uF_open	Panasonic	ECJ-0EF1C104Z_open	PCC1731CT-ND_open
11	3	JP1,JP3,JP5	2-Pin Header	AMP/Tyco	87220-2	A26542-ND
12	5	JP2,JP10,JP13,JP14,JP15	3-Pin Header	AMP/Tyco	87224-3	A26545-ND
13	5	JP4,JP6,JP7,JP8,JP9	2-Pin Header_open	AMP/Tyco	87220-2_open	A26542-ND_open
14	2	JP12,JP111	3-Pin Header_open	AMP/Tyco	87224-3_open	A26545-ND_open
15	1	JP16	2X10-Pin Header, open	AMP/TYCO	87215-7_open	A26580-ND_open
16	1	J1	HEADER 28x2 CONN JACK	AMP/TYCO	3-87215-0	A26588-ND
17	1	J2	PWR_open	CPU Inc	PJ-002A_open	CP-002A-ND_open
18	2	J3,J4	BANANA 2x4 pin	Johnson	108-0740-001	J147-ND
19	1	J5	Jumper_open	Molex	10-89-7082_open	WM26808-ND_open
20	1	J6	IDC1X4	Molex/Waldom Electronics Corp	22-11-2042	WM2702-ND
21	2	J8,J7	SMA_open	Johnson Components	142-0701-851_open	J658-ND_open
22	1	LED1	0603_green_LED	LITE-ON INC Lumex	LTST-C191KGKT_open	160-1446-1-ND_open
23	1	LED2	0402_orange_LED	Opto/Components Inc	SML-LX0402SOC-TR_open	67-1879-1-ND_open
24	1	P1	HSD_2X2_open mini USB	Rosenberger	D4S20B-40ML5-Y_open	
25	1	P2	5pin_open	Hirose	UX60-MB-5ST_open	H2959CT-ND_open
26	1	P3	USB A	AMP/Tyco	292303-1	A31726-ND

27	1	R1	1.50K	Panasonic	ERJ-2RKF1501X	P1.50KLCT-ND
28	5	R2,R38,R44,R54,R55	0 Ohm,0402_open	Panasonic	ERJ-2GEJ0R00X_open	P0.0JTR-ND_open
29	29	R3,R4,R5,R6,R7,R8,R9,R10,R11,R12,R13,R14,R15,R16,R17,R18,R19,R20,R21,R22,R23,R24,R25,R26,R27,R28,R29,R34,R35	49.9ohm_open	Panasonic	ERJ-1GEF49R9C_open	P49.9ABCT-ND_open
30	1	R30	49.9ohm_open	Panasonic	ERJ-6ENF49R9V_open	P49.9CCT-ND_open
31	10	R31,R32,R33,R45,R46,R47,R48,R53,R56,R57	0 Ohm,0402	Panasonic	ERJ-2GEJ0R00X	P0.0JTR-ND
32	1	R36	100K_open	Panasonic	ERJ-3EKF1003V_open	P100KHCT-ND_open
33	8	R37,R58,R59,R60,R61,R62,R63,R64	10K	Panasonic	ERJ-3EKF1002V	P10.0KHCT-ND
34	2	R40,R39	4.7K	Panasonic	ERJ-3GEYJ472V	P4.7KGCT-ND
35	2	R42,R41	82.5ohm_open	Panasonic	ERJ-3EKF82R5V_open	P82.5HCT-ND_open
36	1	R43	100ohm_open	Panasonic	ERJ-3EKF1000V_open	P100HCT-ND_open
37	2	R49,R50	0 ohm_open	Panasonic	ERJ-1GE0R00C_open	P0.0AGCT-ND_open
38	2	R52,R51	0 ohm	Panasonic	ERJ-1GE0R00C	P0.0AGCT-ND
39	1	S1	SW DIP-7	Grayhill	78B07ST	GH7190-ND
40	1	U1	DS92LV2421	National	DS92LV2421	
41	2	U2,U3	LM1117IMP-ADJ/SOT223_open	National	LM1117IMP-ADJ/NOPB_open	LM1117IMP-ADJ/NOPB_open
42	1	U4	Oscillator option	Abracon Corporation	ASFLM-BLANK-LC_open	535-10059-5-ND_open
43	2	VR2,VR1	SVR100_open	Bourns	3214W-1-101E_open	3214W-101ETR-ND_open
44	1	VR3	SVR20K	Bourns	3224W-1-203E	3224W-203ECT-ND
45	1	VR4	SVR100K	Bourns	3224W-1-104E	3224W-1-104ECT-ND
46	2	X2,X1	TP_0402		TP_0402	

Tx Board Schematics

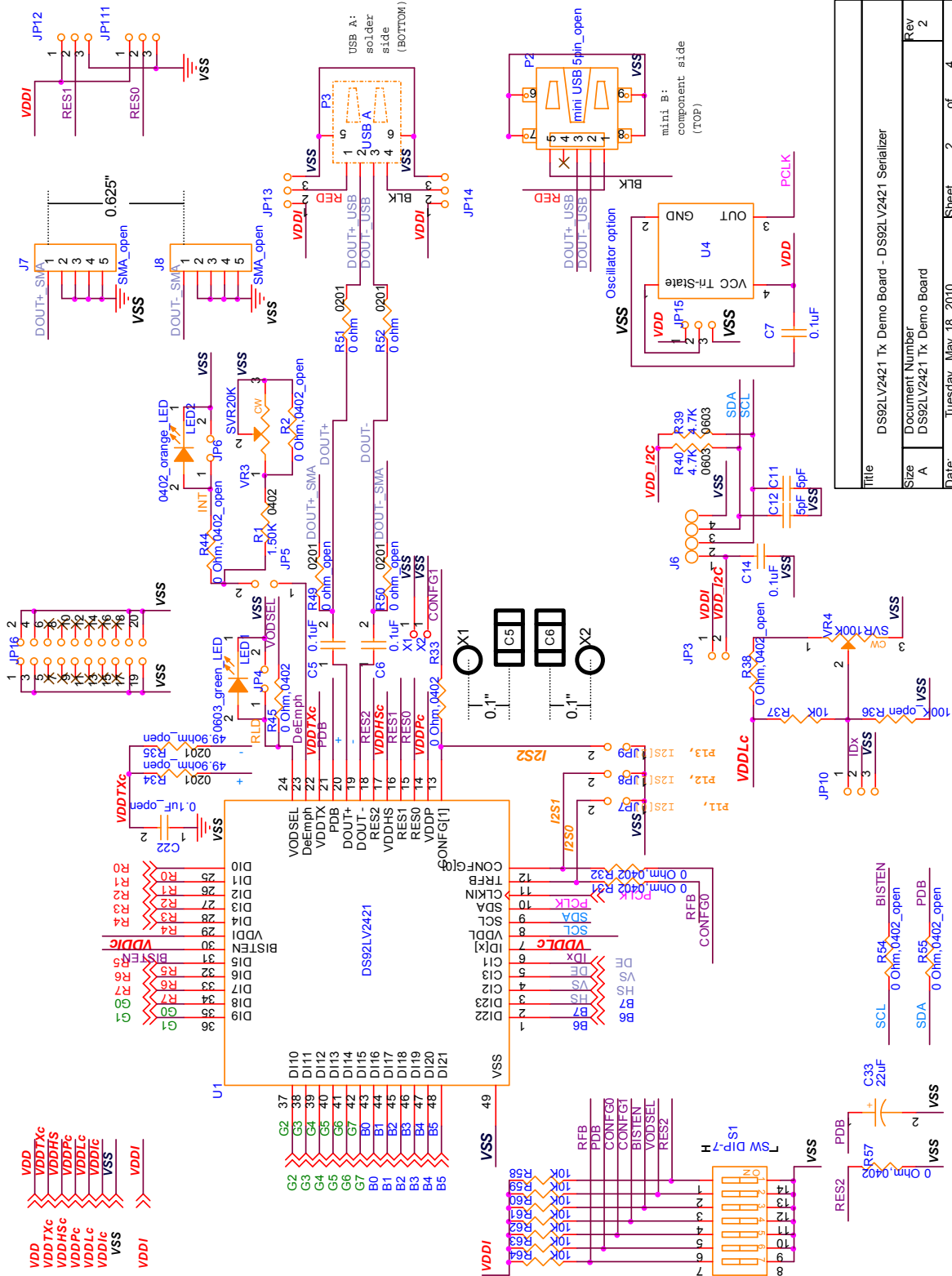

Title	DS92LV2421 Tx Demo Board - DS92LV2421 Serializer
Size	Document Number DS92LV2421 Tx Demo Board
Rev	2
Date:	Tuesday, May 18, 2010
Sheet	2 of 4

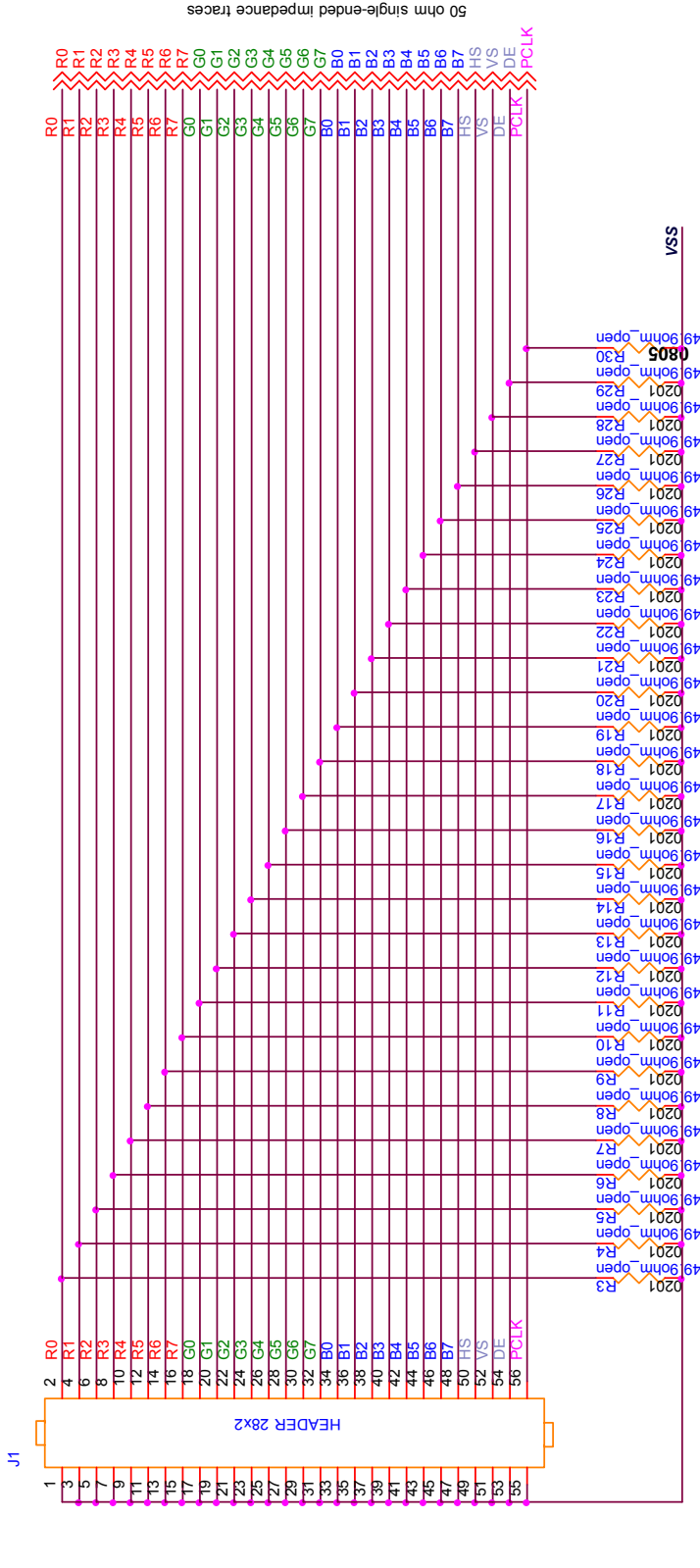

VSS \gg VSS

USER NOTE:
 1) R10-17, G10-17, B10-17, HS, VS, DE, & PCLK are matched length 50 ohm single-ended impedance traces.
 2) R1-R9 parallel 50 ohm termination option for 50 ohm driving source.
 Do not load otherwise.

Title		DS92LV2421 TX Demo Board - Parallel Input	
Size	Document Number	Rev	
A	DS92LV2421 TX Demo Board	2	
Date:	Tuesday, May 18, 2010	Sheet	3 of 4

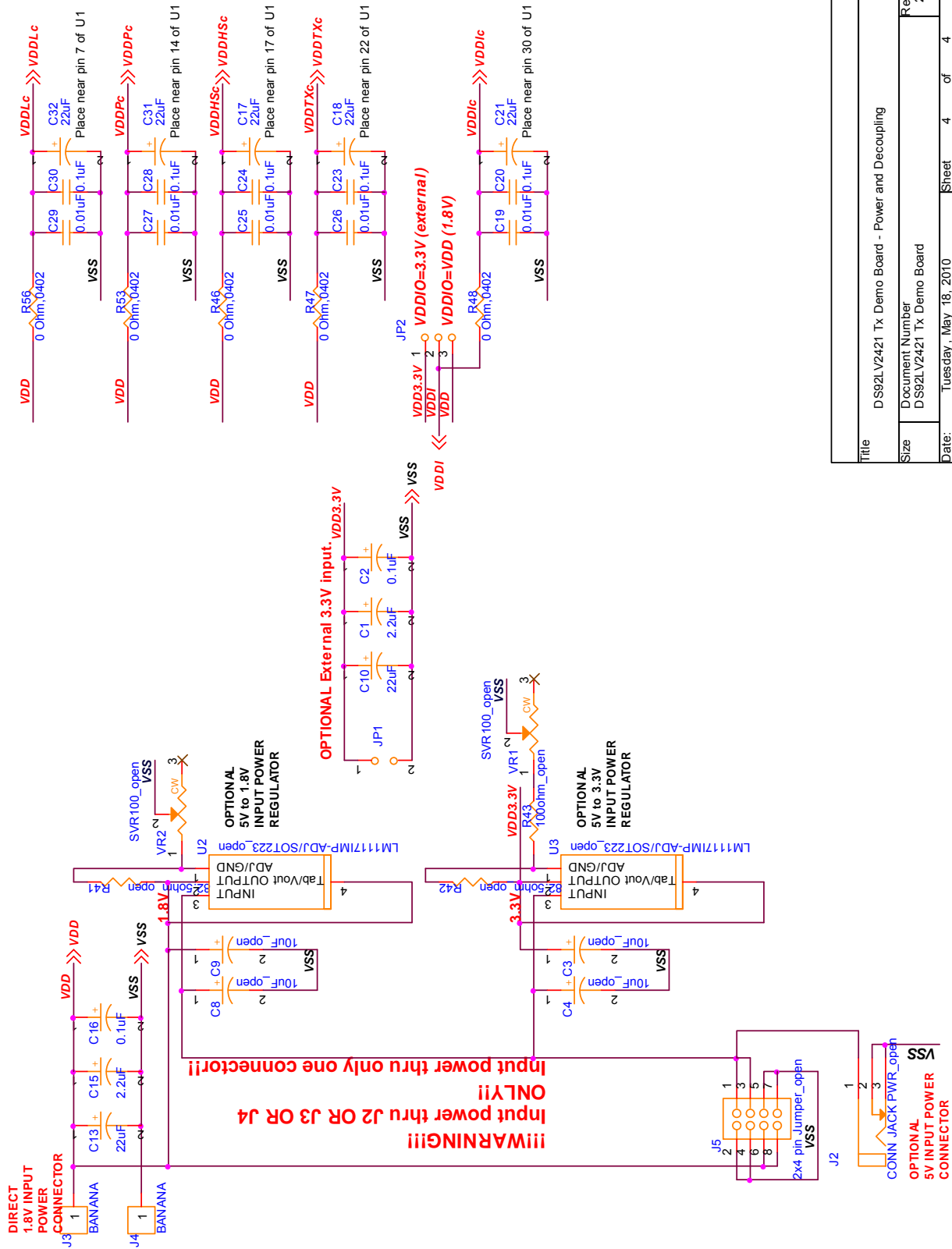

Tx Board Reference Layout

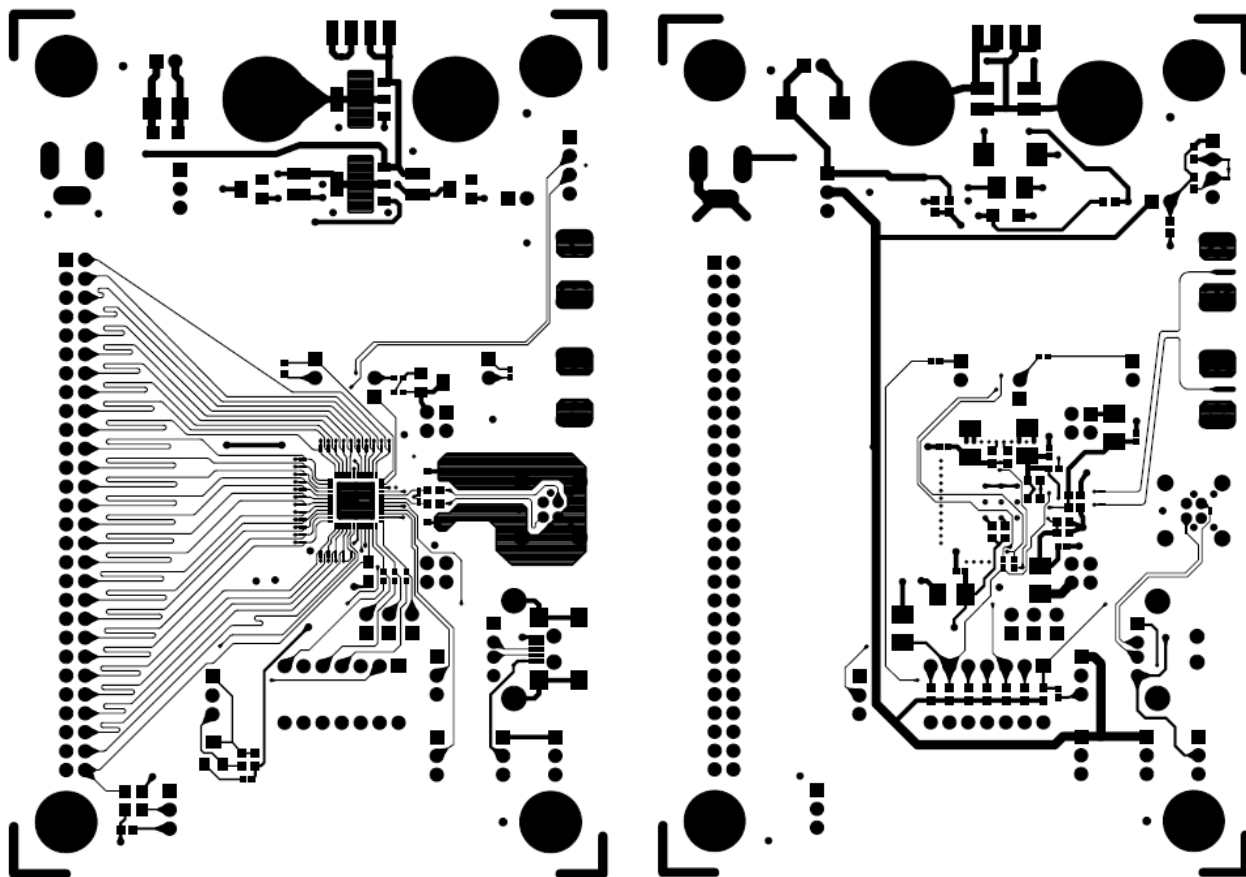

Top Layer

Bottom Layer

Rx Board Configuration Settings

Component	Name	Function
Power Connections		
J7	5V DC	Optional 5V DC Power Jack.
J4	1.8V DC	1.8V VDD Power.
JP1	3.3V DC	3.3V VDD Power (left header pin) and Ground (right header pin)
J5	VSS	Ground.
JP2	VDDIO	Connect to 3.3V for 3.3V input logic levels and I2C interface. Connect to 1.8V for 1.8V input logic levels and no I2C.
Input and Output Connections		
P1	28 position wall header	LVC MOS parallel data output.
J3 and J4	SMA Connector	Channel Link II input. (optional) (When using these connectors, R53 and R54 should be placed with 0Ω resistors, the traces to the J1 should be cut).
J2	USB Connector	Channel Link II input. (default)
JP11 and JP12	Power Wire in USB cable through J2	Connect to VSS is recommended.
P2	USB Connector	Optional Channel Link II loop through driver output.
Control Connections		
S1: 3	BISTEN	Set to "H" for the BIST enable mode. Set to "L" for normal operation. See datasheet for detail information.
S1: 2	RES0	Keep RES0 set to "L"
S1: 1	PDB	Set to "L" for the power down mode. Set to "H" for the normal operation.
JP24 and VR3	ID[x]	Connect JP19 to VSS to have the default device PHY address (h'EC). Connect JP19 to VR4; then adjust VR4 value to select desired device PHY address. See datasheet for detail information.
J3 and JP23	I2C Interface	Connect JP3 if the I2C power is not supplied on J6. Otherwise, leave it unconnected.
Strap Pin Configuration Options		
R[1:28], R41, R42	--	Populate with 10k ohm resistor to enable desired strap option. See datasheet for details on strap options.
Others		
LED1	PASS	PASS output. "ON" when PASS is "H". See datasheet for detail information.
LED2	LOCK	LOCK output. "ON" when LOCK is "H". See datasheet for detail information.
JP11, JP25, JP26	Other options	Do not connect

Rx Board Bill of Materials

Item	Qty	Reference	Part	MFR	MFR Part#	Digi-Key Part#
1	4	C1,C2,C9,C10	10uF_open	nichicon	F931C106MBA_open	493-2365-1-ND_open
2	6	C3,C7,C21,C2 C4,C8,C22,C2	0.1uF	Panasonic	ECJ-1VB1E104K	PCC2277CT-ND
3	5	5,C31	0.01uF	KEMET	C0603C103K1RACTU	399-3189-1-ND
4	4	C5,C6,C15,C1	0.1uF	Panasonic	ECJ-1VB1H104K	PCC2398CT-ND
5	2	C11,C14	22uF	nichicon	F931E226MNC	493-2391-1-ND
6	2	C12,C17	2.2uF	KEMET	T491B225K020AT	399-3714-1-ND
7	2	C18,C13 C19,C20,C24,	0.1uF	KEMET	C1206C104K5RACTU	399-1249-1-ND
8	6	C28,C32,C33	22uF	Kemet	T494B226M016AT	399-3835-1-ND
9	2	C23,C27	0.1uF_open	Panasonic	ECJ-0EF1C104Z_open	PCC1731CT-ND_open
10	1	C26	4.7uF	Panasonic	ECJ-0EB0J475M	PCC2475TR-ND
11	2	C35,C36	5pF	Panasonic	ECJ-ZEC1E050C	PCC2107CT-ND
12	2	JP1,JP16 JP2,JP17,JP1	2-Pin Header	AMP/Tyco	87220-2	A26542-ND
13	3	8	3-Pin Header	AMP/Tyco	87224-3	A26545-ND
14	9	JP3,JP4,JP5,J P6,JP7,JP10, JP13,JP14,JP 15	3-Pin Header_open	AMP/Tyco	87224-3_open	A26545-ND_open
15	2	JP8,JP9	2-Pin Header_open	AMP/Tyco	87220-2_open	A26542-ND_open
16	2	JP11,JP12	3-Pin Header	AMP/Tyco	87224-3	A26545-ND
17	1	JP19	2X10-Pin Header, open	AMP/TYCO	87215-7_open	A26580-ND_open
18	1	J1	HSD_2X2_op en mini USB	Rosenberger	D4S20B-40ML5- Y_open	
19	1	J2	5pin	Hirose	UX60-MB-5ST	H2959CT-ND
20	1	J3	IDC1X4	Molex/Waldom Electr	22-11-2042	WM2702-ND
21	2	J4,J5	BANANA	Johnson	108-0740-001	J147-ND
22	1	J6	2x4 pin Jumper_open	Molex	10-89-7082_open	WM26808-ND_open
23	1	J7	CONN JACK			
24	2	J9,J8	PWR_open SMA_open mini USB	CPU Inc Johnson Components	PJ-002A_open 142-0701-851_open	CP-002A-ND_open J658-ND_open
25	1	J10	5pin_open 0402_orange	Hirose	UX60-MB-5ST_open	H2959CT-ND_open
26	1	LED1	_LED 0603_green_	Lumex Opto/Compon	SML-LX0402SOC-TR	67-1879-1-ND
27	1	LED2	LED	LITE-ON INC	LTST-C191KGKT	160-1446-1-ND

28	1	P1	HEADER 28x2	AMP/TYCO	3-87215-0	A26588-ND
29	1	P2	USB A_open	AMP/Tyco	292303-1_open	A31726-ND_open
30	30	5,R6,R7,R8, R9,R10,R11,R1 2,R13,R14, R15,R16,R17,R 18,R19,R20, R21,R22,R23,R 24,R25,R26, R27,R28,R41,R 42 R29,R30,R53,R	10Kohm_open	Panasonic	ERJ-1GEJ103C_open	P10KAGCT-ND_open
31	4	54	0 ohm_open	Panasonic	ERJ-1GE0R00C_open	P0.0AGCT-ND_open
32	4	39	10K	Panasonic	ERJ-3EKF1002V	P10.0KHCT-ND
33	1	R32	100K_open	Panasonic	ERJ-3EKF1003V_open	P100KHCT-ND_open
34	1	R33	0 Ohm,0402_open	Panasonic	ERJ-2GEJ0R00X_open	P0.0JTR-ND_open
35	2	R35,R34	82.5ohm_open	Panasonic	ERJ-3EKF82R5V_open	P82.5HCT-ND_open
36	1	R36	100ohm_open	Panasonic	ERJ-3EKF1000V_open	P100HCT-ND_open
37	8	45,R46,R47, R59,R60	0 Ohm,0402	Panasonic	ERJ-2GEJ0R00X	P0.0JTR-ND
38	2	R49,R48 R50,R51,R52,R	1K Ohm,0402_open	Panasonic	ERJ-2GEJ102X_open	P1.0KJCT-ND_open
39	4	55	49.9ohm_open	Panasonic	ERJ-1GEF49R9C_open	P49.9ABCT-ND_open
40	3	R56,R57,R58	0 ohm	Panasonic	ERJ-1GE0R00C	P0.0AGCT-ND
41	2	R62,R61	4.7K	Panasonic	ERJ-3GEYJ472V	P4.7KGCT-ND
42	1	S1	SW DIP-3	Grayhill	78B03ST	GH7182-ND
43	1	U1	DS92LV2422	National	DS92LV2422	
44	2	U2,U3	LM1117IMP- ADJ/SOT223_open	National	LM1117IMP- ADJ/NOPB_open	LM1117IMP- ADJ/NOPB_open
45	2	VR2,VR1	SVR100_open	Bourns	3214W-1-101E_open	3214W-101ETR- ND_open
46	1	VR3	SVR50K	Bourns	3224W-1-503E	3224W-1-503ECT-ND
47	2	X2,X1	TP_0402		TP_0402	

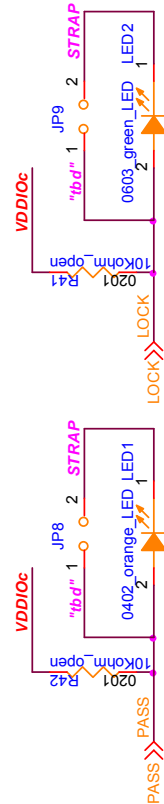
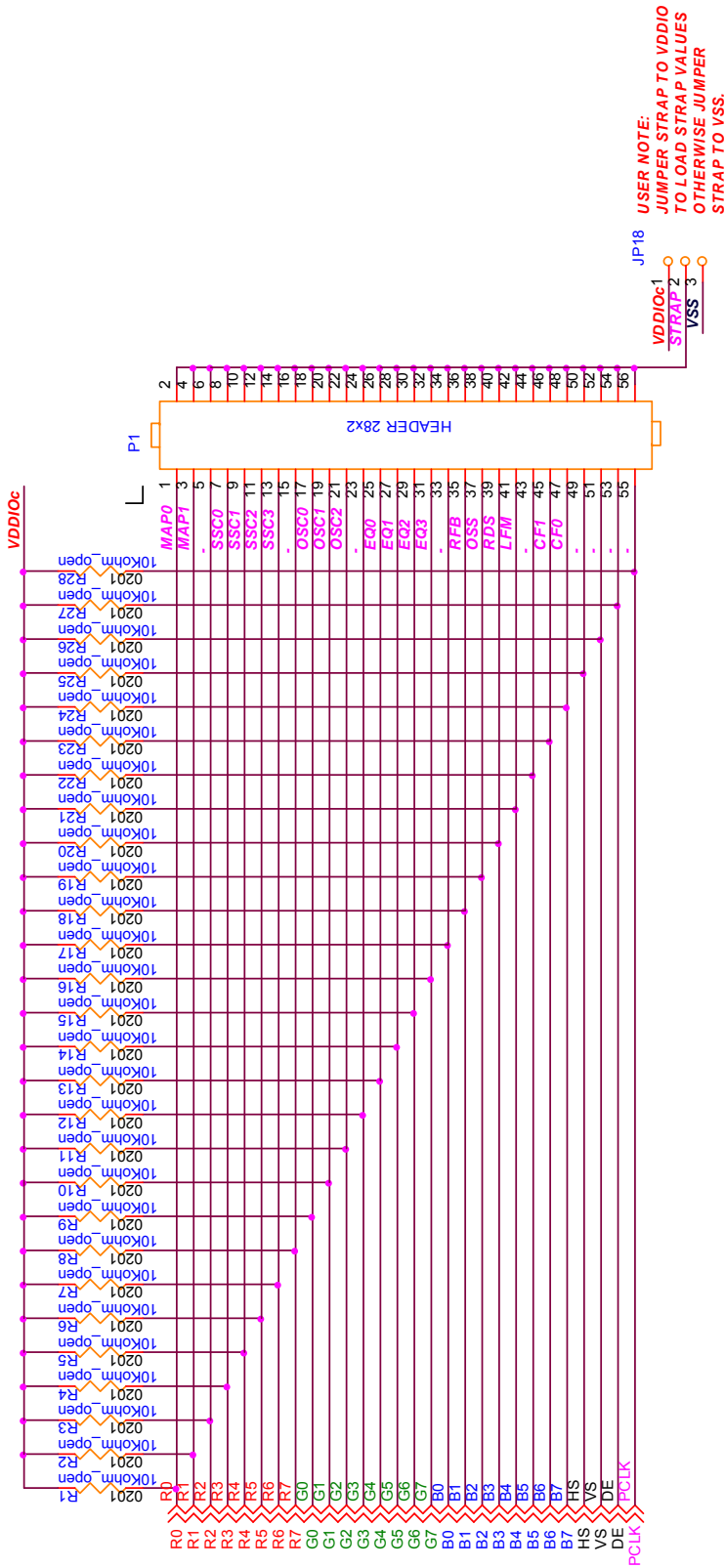
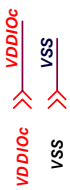

Title		DS92LV2422 Rx Demo Board - Parallel Output		
Size	Document Number	DS92LV2422 Rx Demo Board		
A	Rev	2		
Date:	Wednesday, May 19, 2010	Sheet	4	of 5

USER NOTE:
JUMPER STRAP TO VDDIO
TO LOAD STRAP VALUES
OTHERWISE JUMPER
STRAP TO VSS.

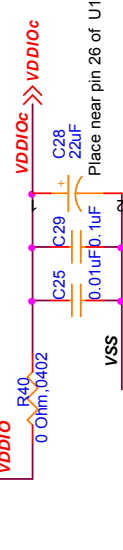
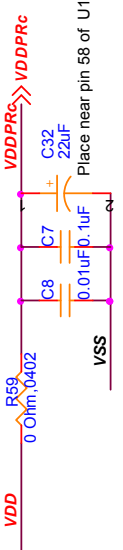
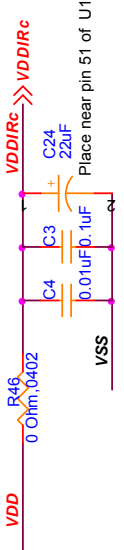
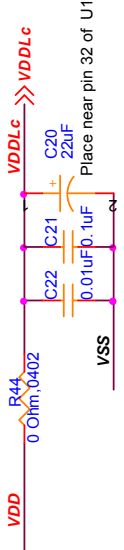
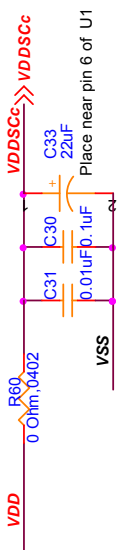
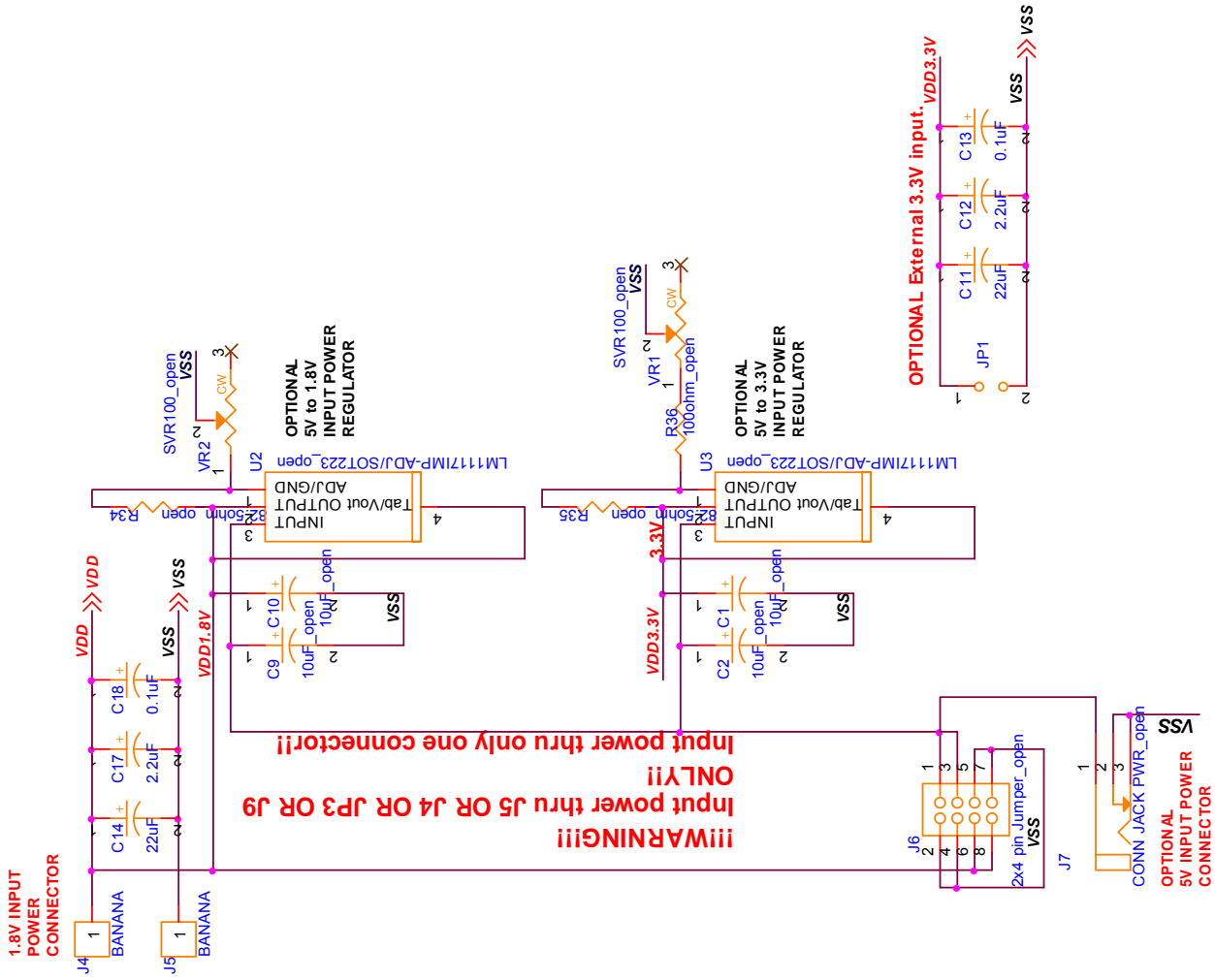

Title			
DS92LV2422 Rx Demo Board - Power and Decoupling			
Size	Document Number	Rev	
	DS92LV2422 Rx Demo Board	2	
Date:	Wednesday, May 19, 2010	Sheet	4 of 4

Rx Board Reference Layout

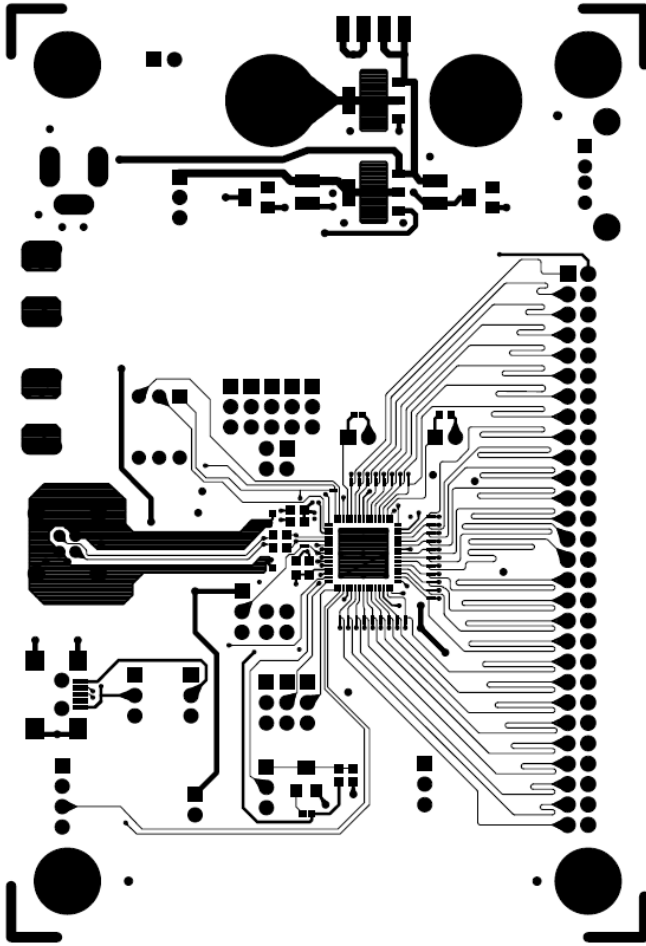

Top Layer

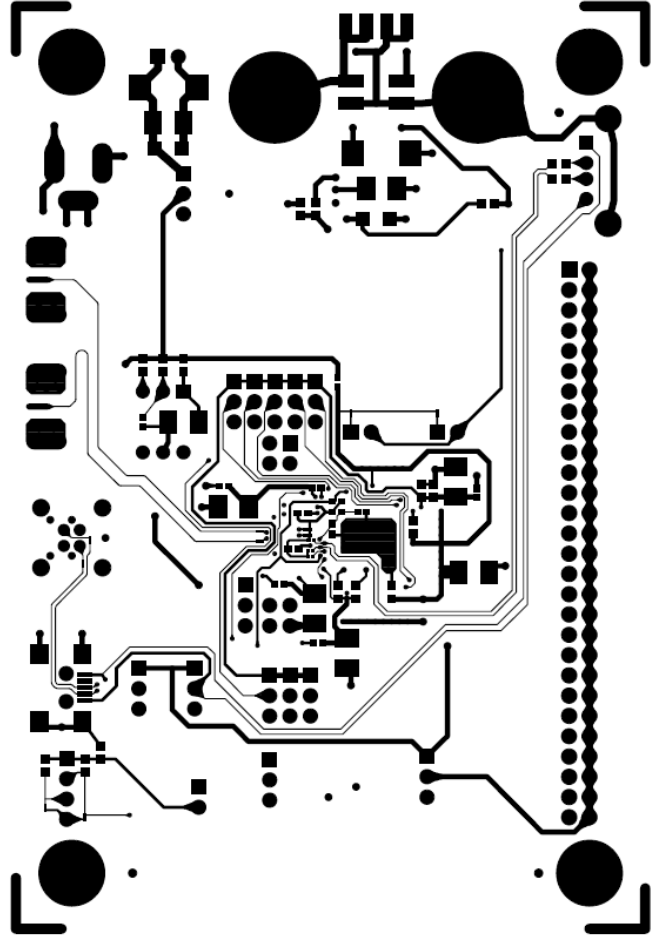

Bottom Layer

IMPORTANT NOTICE

Texas Instruments Incorporated and its subsidiaries (TI) reserve the right to make corrections, modifications, enhancements, improvements, and other changes to its products and services at any time and to discontinue any product or service without notice. Customers should obtain the latest relevant information before placing orders and should verify that such information is current and complete. All products are sold subject to TI's terms and conditions of sale supplied at the time of order acknowledgment.

TI warrants performance of its hardware products to the specifications applicable at the time of sale in accordance with TI's standard warranty. Testing and other quality control techniques are used to the extent TI deems necessary to support this warranty. Except where mandated by government requirements, testing of all parameters of each product is not necessarily performed.

TI assumes no liability for applications assistance or customer product design. Customers are responsible for their products and applications using TI components. To minimize the risks associated with customer products and applications, customers should provide adequate design and operating safeguards.

TI does not warrant or represent that any license, either express or implied, is granted under any TI patent right, copyright, mask work right, or other TI intellectual property right relating to any combination, machine, or process in which TI products or services are used. Information published by TI regarding third-party products or services does not constitute a license from TI to use such products or services or a warranty or endorsement thereof. Use of such information may require a license from a third party under the patents or other intellectual property of the third party, or a license from TI under the patents or other intellectual property of TI.

Reproduction of TI information in TI data books or data sheets is permissible only if reproduction is without alteration and is accompanied by all associated warranties, conditions, limitations, and notices. Reproduction of this information with alteration is an unfair and deceptive business practice. TI is not responsible or liable for such altered documentation. Information of third parties may be subject to additional restrictions.

Resale of TI products or services with statements different from or beyond the parameters stated by TI for that product or service voids all express and any implied warranties for the associated TI product or service and is an unfair and deceptive business practice. TI is not responsible or liable for any such statements.

TI products are not authorized for use in safety-critical applications (such as life support) where a failure of the TI product would reasonably be expected to cause severe personal injury or death, unless officers of the parties have executed an agreement specifically governing such use. Buyers represent that they have all necessary expertise in the safety and regulatory ramifications of their applications, and acknowledge and agree that they are solely responsible for all legal, regulatory and safety-related requirements concerning their products and any use of TI products in such safety-critical applications, notwithstanding any applications-related information or support that may be provided by TI. Further, Buyers must fully indemnify TI and its representatives against any damages arising out of the use of TI products in such safety-critical applications.

TI products are neither designed nor intended for use in military/aerospace applications or environments unless the TI products are specifically designated by TI as military-grade or "enhanced plastic." Only products designated by TI as military-grade meet military specifications. Buyers acknowledge and agree that any such use of TI products which TI has not designated as military-grade is solely at the Buyer's risk, and that they are solely responsible for compliance with all legal and regulatory requirements in connection with such use.

TI products are neither designed nor intended for use in automotive applications or environments unless the specific TI products are designated by TI as compliant with ISO/TS 16949 requirements. Buyers acknowledge and agree that, if they use any non-designated products in automotive applications, TI will not be responsible for any failure to meet such requirements.

Following are URLs where you can obtain information on other Texas Instruments products and application solutions:

Products

Audio	www.ti.com/audio
Amplifiers	amplifier.ti.com
Data Converters	dataconverter.ti.com
DLP® Products	www.dlp.com
DSP	dsp.ti.com
Clocks and Timers	www.ti.com/clocks
Interface	interface.ti.com
Logic	logic.ti.com
Power Mgmt	power.ti.com
Microcontrollers	microcontroller.ti.com
RFID	www.ti-rfid.com
OMAP Mobile Processors	www.ti.com/omap
Wireless Connectivity	www.ti.com/wirelessconnectivity

Applications

Automotive and Transportation	www.ti.com/automotive
Communications and Telecom	www.ti.com/communications
Computers and Peripherals	www.ti.com/computers
Consumer Electronics	www.ti.com/consumer-apps
Energy and Lighting	www.ti.com/energy
Industrial	www.ti.com/industrial
Medical	www.ti.com/medical
Security	www.ti.com/security
Space, Avionics and Defense	www.ti.com/space-avionics-defense
Video and Imaging	www.ti.com/video

TI E2E Community Home Page

e2e.ti.com

Mailing Address: Texas Instruments, Post Office Box 655303, Dallas, Texas 75265
Copyright © 2012, Texas Instruments Incorporated