



# STGW35NB60SD

N-CHANNEL 35A - 600V - TO-247  
Low Drop PowerMESH™ IGBT

## General features

| Type         | V <sub>CES</sub> | V <sub>CE(sat)</sub><br>(Max) @ 25°C | I <sub>C</sub><br>@ 100°C |
|--------------|------------------|--------------------------------------|---------------------------|
| STGW35NB60SD | 600V             | < 1.7V                               | 35A                       |

- LOW ON-VOLTAGE DROP (V<sub>CEsat</sub>)
- LOW INPUT CAPACITANCE
- HIGH CURRENT CAPABILITY

## Description

Using the latest high voltage technology based on a patented strip layout, STMicroelectronics has designed an advanced family of IGBTs, the PowerMESH™ IGBTs, with outstanding performances.

## Applications

- LIGHT DIMMER
- HID
- WELDING
- MOTOR CONTROL
- STATIC RELAYS

## Order codes

| Sales Type   | Marking    | Package | Packaging |
|--------------|------------|---------|-----------|
| STGW35NB60SD | GW35NB60SD | TO-247  | TUBE      |

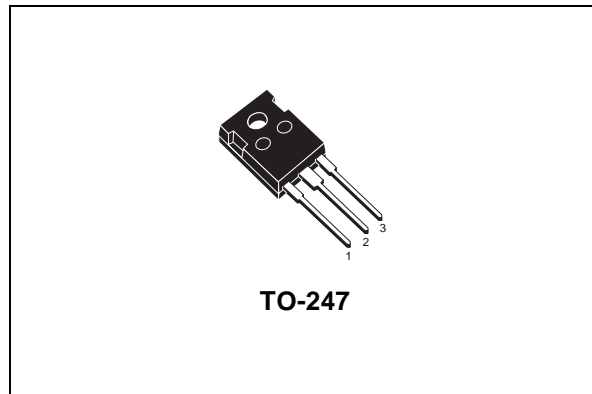

## Internal schematic diagram

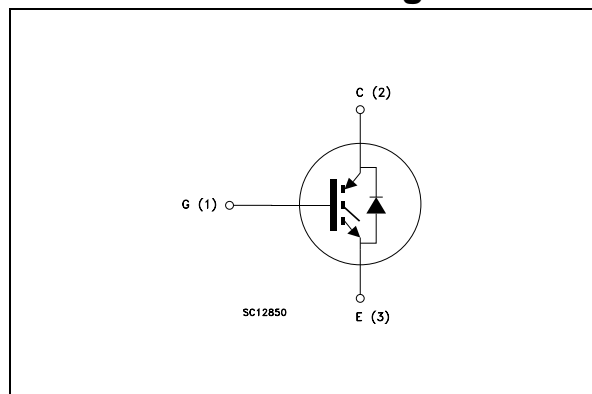

# 1 Electrical ratings

**Table 1. Absolute maximum ratings**

| Symbol                 | Parameter  | Value       | Unit |
|------------------------|--|-------------|------|
| $V_{CES}$              | Collector-Emitter Voltage ( $V_{GS} = 0$ )                                   | 600         | V    |
| $I_C$ <i>Note 4</i>    | Collector Current (continuous) at 25°C                                       | 70          | A    |
| $I_C$ <i>Note 4</i>    | Collector Current (continuous) at 100°C                                      | 35          | A    |
| $I_{CM}$ <i>Note 1</i> | Collector Current (pulsed)   | 250         | A    |
| $V_{GE}$               | Gate-Emitter Voltage   | ± 20        | V    |
| $I_f$                  | Diode RMS Forward Current at $T_C = 25^\circ\text{C}$                        | 30          | A    |
| $P_{TOT}$              | Total Dissipation at $T_C = 25^\circ\text{C}$                                | 200         | W    |
| $T_j$                  | Operating Junction Temperature   | – 55 to 150 | °C   |
| $T_{stg}$              | Storage Temperature  |             |      |
| $T_L$                  | Maximum Lead Temperature for Soldering Purpose (1.6mm from case, for 10sec.) | 300         | °C   |

**Table 2. Thermal resistance**

|           |  | Min. | Typ. | Max.  | Unit |
|-----------|--|------|------|-------|------|
| Rthj-case | Thermal Resistance Junction-case (IGBT)  | --   | --   | 0.625 | °C/W |
| Rthj-case | Thermal Resistance Junction-case (DIODE) | --   | --   | 1.5   | °C/W |
| Rthj-amb  | Thermal Resistance Junction-ambient      | --   | --   | 50    | °C/W |

## 2 Electrical characteristics

( $T_{CASE} = 25\text{ °C}$  unless otherwise specified)

**Table 3. Static**

| Symbol        | Parameter  | Test Conditions   | Min. | Typ.        | Max.      | Unit                           |
|---------------|--|---|------|-------------|-----------|--------------------------------|
| $V_{BR(CES)}$ | Collectro-Emitter Breakdown Voltage                | $I_C = 1\text{ mA}, V_{GE} = 0$   | 600  |             |           | V                              |
| $V_{CE(SAT)}$ | Collector-Emitter Saturation Voltage               | $V_{GE} = 15\text{ V}, I_C = 20\text{ A}, T_j = 25\text{ °C}$<br>$V_{GE} = 15\text{ V}, I_C = 20\text{ A}, T_j = 125\text{ °C}$ |      | 1.25<br>1.2 | 1.7       | V<br>V                         |
| $V_{GE(th)}$  | Gate Threshold Voltage                             | $V_{CE} = V_{GE}, I_C = 250\text{ }\mu\text{A}$   | 2.5  |             | 5         | V                              |
| $I_{CES}$     | Collector-Emitter Leakage Current ( $V_{GE} = 0$ ) | $V_{CE} = \text{Max Rating}, T_c = 25\text{ °C}$<br>$V_{CE} = \text{Max Rating}, T_c = 125\text{ °C}$                           |      |             | 10<br>100 | $\mu\text{A}$<br>$\mu\text{A}$ |
| $I_{GES}$     | Gate-Emitter Leakage Current ( $V_{CE} = 0$ )      | $V_{GE} = \pm 20\text{ V}, V_{CE} = 0$  |      |             | $\pm 100$ | nA                             |
| $g_{fs}$      | Forward Transconductance                           | $V_{CE} = 10\text{ V}, I_C = 18\text{ A}$   |      | 20          |           | S                              |

**Table 4. Dynamic**

| Symbol    | Parameter                    | Test Conditions   | Min. | Typ. | Max. | Unit |
|-----------|------------------------------|---|------|------|------|------|
| $C_{ies}$ | Input Capacitance            | $V_{CE} = 25\text{ V}, f = 1\text{ MHz}, V_{GE} = 0$                                      |      | 1820 |      | pF   |
| $C_{oes}$ | Output Capacitance           |   |      | 167  |      | pF   |
| $C_{res}$ | Reverse Transfer Capacitance |   |      | 27   |      | pF   |
| $Q_g$     | Total Gate Charge            | $V_{CE} = 480\text{ V}, I_C = 20\text{ A},$<br>$V_{GE} = 15\text{ V},$<br>(see Figure 17) |      | 83   | 115  | nC   |
| $Q_{ge}$  | Gate-Emitter Charge          |   |      | 10   |      | nC   |
| $Q_{gc}$  | Gate-Collector Charge        |   |      | 27   |      | nC   |
| $I_{CL}$  | Turn-Off SOA Minimum Current | $V_{clamp} = 480\text{ V}, T_j = 125\text{ °C}$<br>$R_G = 100\text{ }\Omega$              | 80   |      |      | A    |

**Table 5. Switching on/off (inductive load)**

| Symbol                                  | Parameter   | Test Conditions   | Min. | Typ.                | Max. | Unit                          |
|---|---|---|------|---------------------|------|-------------------------------|
| $t_{d(on)}$<br>$t_r$<br>$(di/dt)_{on}$  | Turn-on Delay Time<br>Current Rise Time<br>Turn-on Current Slope  | $V_{CC} = 480V, I_C = 20A$<br>$R_G = 100\Omega, V_{GE} = 15V, T_j = 25^\circ C$<br>(see Figure 3)       |      | 92<br>70<br>340     |      | ns<br>ns<br>A/ $\mu s$        |
| $t_{d(on)}$<br>$t_r$<br>$(di/dt)_{on}$  | Turn-on Delay Time<br>Current Rise Time<br>Turn-on Current Slope  | $V_{CC} = 480V, I_C = 20A$<br>$R_G = 100\Omega, V_{GE} = 15V, T_j = 125^\circ C$<br>(see Figure 3)      |      | 80<br>73<br>320     |      | ns<br>ns<br>A/ $\mu s$        |
| $t_r(V_{off})$<br>$t_{d(off)}$<br>$t_f$ | Off Voltage Rise Time<br>Turn-off Delay Time<br>Current Fall Time | $V_{CC} = 480V, I_C = 20A,$<br>$R_{GE} = 100\Omega, V_{GE} = 5V, T_j = 25^\circ C$<br>(see Figure 18)   |      | 0.78<br>1.1<br>0.79 |      | $\mu s$<br>$\mu s$<br>$\mu s$ |
| $t_r(V_{off})$<br>$t_{d(off)}$<br>$t_f$ | Off Voltage Rise Time<br>Turn-off Delay Time<br>Current Fall Time | $V_{CC} = 480V, I_C = 20A,$<br>$R_{GE} = 100\Omega, V_{GE} = 15V, T_j = 125^\circ C$<br>(see Figure 18) |      | 1.1<br>2.4<br>1.2   |      | $\mu s$<br>$\mu s$<br>$\mu s$ |

**Table 6. Switching energy (inductive load)**

| Symbol  | Parameter   | Test Conditions   | Min. | Typ.                 | Max. | Unit           |
|---|---|---|------|----------------------|------|----------------|
| $E_{on}$ <i>Note 2</i><br>$E_{off}$ <i>Note 3</i><br>$E_{ts}$ | Turn-on Switching Losses<br>Turn-off Switching Losses<br>Total Switching Losses | $V_{CC} = 480V, I_C = 20A$<br>$R_G = 100\Omega, V_{GE} = 15V, T_j = 25^\circ C$<br>(see Figure 18)  |      | 0.84<br>7.4<br>8.24  |      | mJ<br>mJ<br>mJ |
| $E_{on}$ <i>Note 2</i><br>$E_{off}$ <i>Note 3</i><br>$E_{ts}$ | Turn-on Switching Losses<br>Turn-off Switching Losses<br>Total Switching Losses | $V_{CC} = 480V, I_C = 20A$<br>$R_G = 100\Omega, V_{GE} = 15V, T_j = 125^\circ C$<br>(see Figure 18) |      | 0.86<br>11.5<br>12.4 |      | mJ<br>mJ<br>mJ |

**Table 7. Collector-emitter diode**

| Symbol           | Parameter                    | Test Conditions   | Min. | Typ.  | Max. | Unit |
|------------------|------------------------------|---|------|-------|------|------|
| V <sub>f</sub>   | Forward On-Voltage           | I <sub>f</sub> = 10A  |      | 1.3   | 2    | V    |
|                  |                              | I <sub>f</sub> = 10A, T <sub>j</sub> = 125°C  |      | 1     |      | V    |
| t <sub>rr</sub>  | Reverse Recovery Time        | I <sub>f</sub> = 20A, V <sub>R</sub> = 40V,<br>T <sub>j</sub> = 25°C, di/dt = 100A/μs<br>(see Figure 19)  |      | 44    |      | ns   |
| t <sub>a</sub>   |                              |   |      | 32    |      | ns   |
| Q <sub>rr</sub>  | Reverse Recovery Charge      |   |      | 66    |      | nC   |
| I <sub>rrm</sub> | Reverse Recovery Current     |   |      | 3     |      | A    |
| S                | Softness factor of the diode |   |      | 0.375 |      |      |
| t <sub>rr</sub>  | Reverse Recovery Time        | I <sub>f</sub> = 20A, V <sub>R</sub> = 40V,<br>T <sub>j</sub> = 125°C, di/dt = 100A/μs<br>(see Figure 19) |      | 88    |      | ns   |
| t <sub>a</sub>   |                              |   |      | 56    |      | ns   |
| Q <sub>rr</sub>  | Reverse Recovery Charge      |   |      | 237   |      | nC   |
| I <sub>rrm</sub> | Reverse Recovery Current     |   |      | 5.4   |      | A    |
| S                | Softness factor of the diode |   |      | 0.57  |      |      |

(1) Pulse width limited by max. junction temperature

(2) E<sub>on</sub> is the turn-on losses when a typical diode is used in the test circuit in figure 2 E<sub>on</sub> include diode recovery energy. If the IGBT is offered in a package with a co-pak diode, the co-pak diode is used as external diode. IGBTs & Diode are at the same temperature (25°C and 125°C)

(3) Turn-off losses include also the tail of the collector current

(4) Calculated according to the iterative formula:

$$I_C(T_C) = \frac{T_{JMAX} - T_C}{R_{THJ-C} \times V_{CESAT(MAX)}(T_C, I_C)}$$

## 2.1 Electrical characteristics (curves)

Figure 1. Output Characteristics

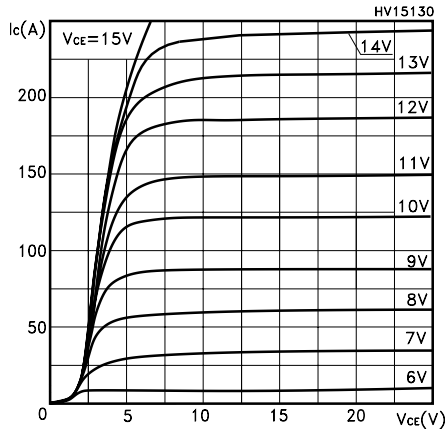

Figure 2. Transfer Characteristics

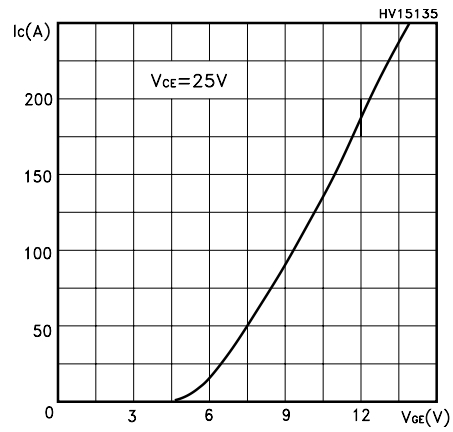

Figure 3. Transconductance

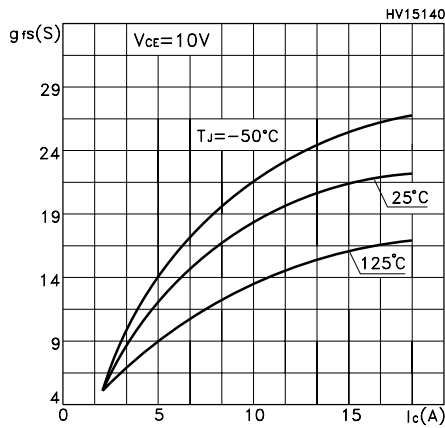

Figure 4. Normalized Collector-Emitter On Voltage vs Temperature

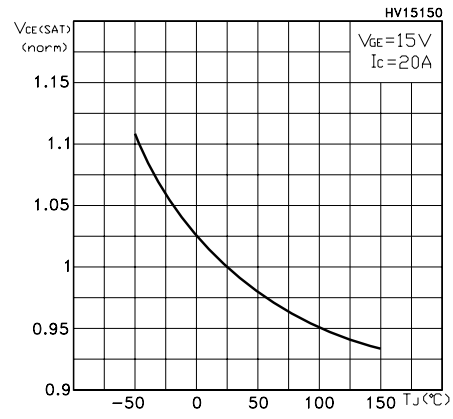

Figure 5. Collector-Emitter on Voltage vs Collector Current

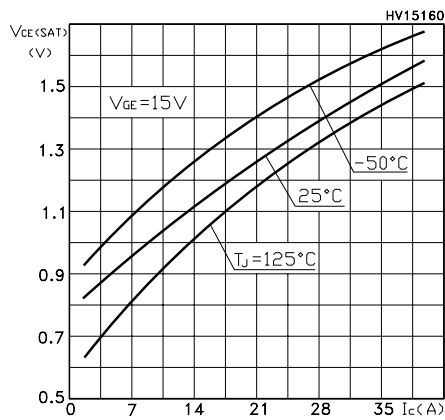

Figure 6. Gate Threshold vs Temperature

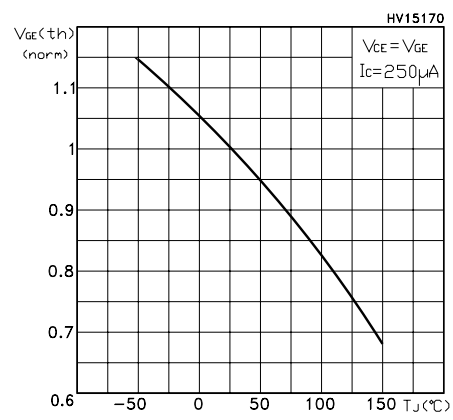

Figure 7. Normalized Breakdown Voltage vs Temperature

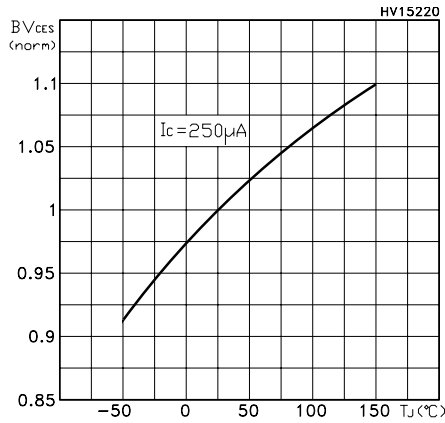

Figure 8. Gate Charge vs Gate-Emitter Voltage

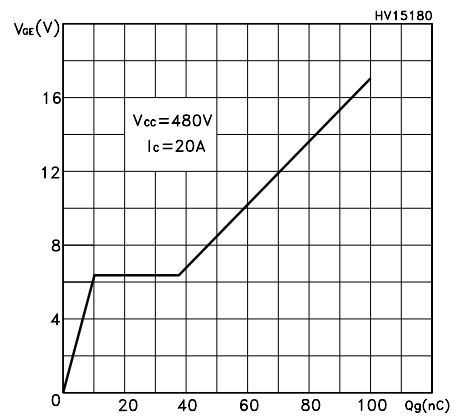

Figure 9. Capacitance Variations

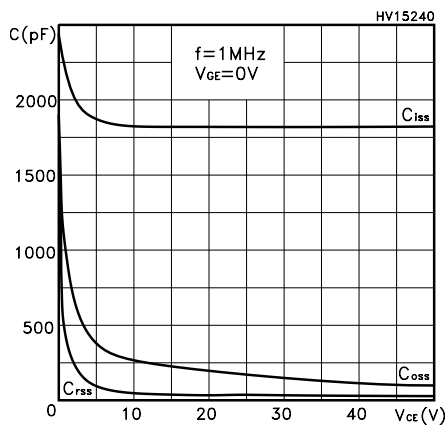

Figure 10. Switching Losses vs Gate Charge

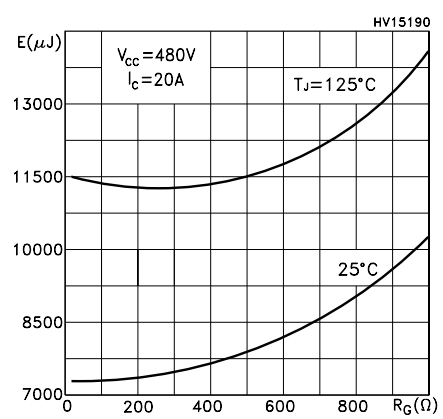

Figure 11. Switching Losses vs Temperature

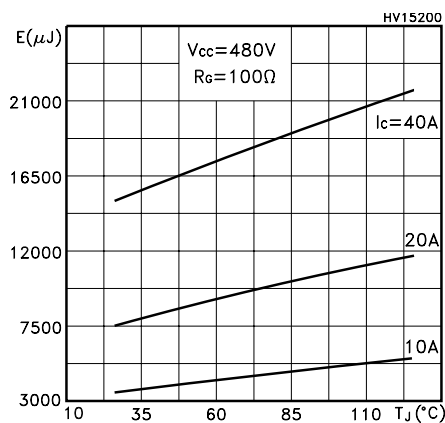

Figure 12. Switching Losses vs Collector Current

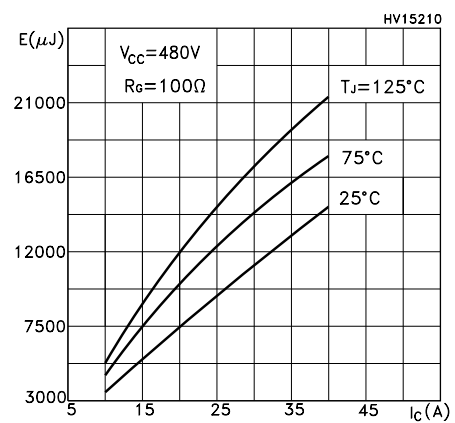

Figure 13. Thermal Impedance

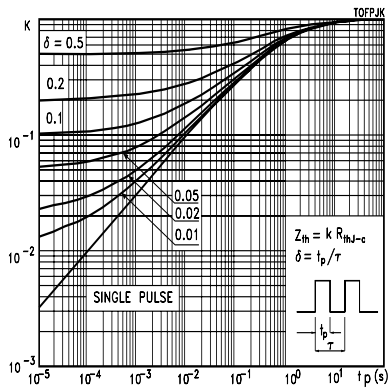

Figure 14. Turn-Off SOA

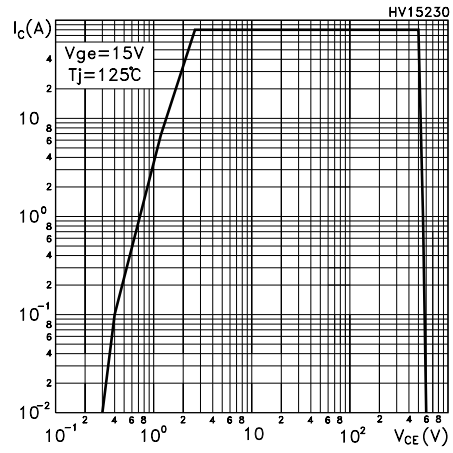
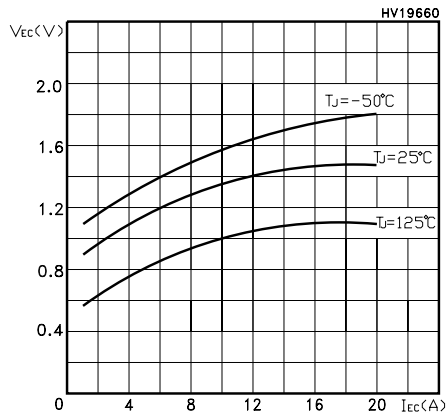

Figure 15. Emitter-Collector Diode Characteristics







## 4 Package mechanical data

In order to meet environmental requirements, ST offers these devices in ECOPACK® packages. These packages have a Lead-free second level interconnect . The category of second level interconnect is marked on the package and on the inner box label, in compliance with JEDEC Standard JESD97. The maximum ratings related to soldering conditions are also marked on the inner box label. ECOPACK is an ST trademark. ECOPACK specifications are available at: [www.st.com](http://www.st.com)

**TO-247 MECHANICAL DATA**

| DIM. | mm.   |       |       | inch  |       |       |
|------|-------|-------|-------|-------|-------|-------|
|      | MIN.  | TYP   | MAX.  | MIN.  | TYP.  | MAX.  |
| A    | 4.85  |       | 5.15  | 0.19  |       | 0.20  |
| A1   | 2.20  |       | 2.60  | 0.086 |       | 0.102 |
| b    | 1.0   |       | 1.40  | 0.039 |       | 0.055 |
| b1   | 2.0   |       | 2.40  | 0.079 |       | 0.094 |
| b2   | 3.0   |       | 3.40  | 0.118 |       | 0.134 |
| c    | 0.40  |       | 0.80  | 0.015 |       | 0.03  |
| D    | 19.85 |       | 20.15 | 0.781 |       | 0.793 |
| E    | 15.45 |       | 15.75 | 0.608 |       | 0.620 |
| e    |       | 5.45  |       |       | 0.214 |       |
| L    | 14.20 |       | 14.80 | 0.560 |       | 0.582 |
| L1   | 3.70  |       | 4.30  | 0.14  |       | 0.17  |
| L2   |       | 18.50 |       |       | 0.728 |       |
| øP   | 3.55  |       | 3.65  | 0.140 |       | 0.143 |
| øR   | 4.50  |       | 5.50  | 0.177 |       | 0.216 |
| S    |       | 5.50  |       |       | 0.216 |       |

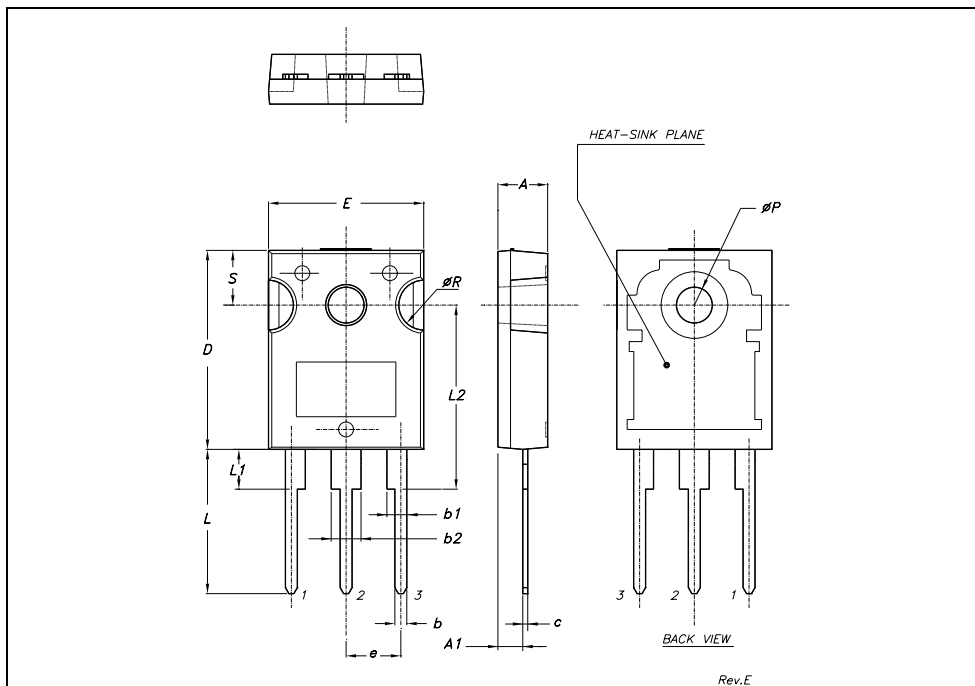

## 5 Revision History

| Date        | Revision | Changes          |
|-------------|----------|------------------|
| 16-Nov-2005 | 1        | Initial release. |

Information furnished is believed to be accurate and reliable. However, STMicroelectronics assumes no responsibility for the consequences of use of such information nor for any infringement of patents or other rights of third parties which may result from its use. No license is granted by implication or otherwise under any patent or patent rights of STMicroelectronics. Specifications mentioned in this publication are subject to change without notice. This publication supersedes and replaces all information previously supplied. STMicroelectronics products are not authorized for use as critical components in life support devices or systems without express written approval of STMicroelectronics.

The ST logo is a registered trademark of STMicroelectronics.  
All other names are the property of their respective owners

© 2005 STMicroelectronics - All rights reserved

STMicroelectronics group of companies

Australia - Belgium - Brazil - Canada - China - Czech Republic - Finland - France - Germany - Hong Kong - India - Israel - Italy - Japan -  
Malaysia - Malta - Morocco - Singapore - Spain - Sweden - Switzerland - United Kingdom - United States of America

[www.st.com](http://www.st.com)

