

Complementary transistor pair in a single package

Features

- Low $V_{CE(sat)}$
- Simplified circuit design
- Reduced component count
- Low spread of dynamic parameters

Application

- Compact fluorescent lamp (CFL) 220 V mains

Description

The STD830CP40 is a hybrid complementary pair of power bipolar transistors manufactured by using the high voltage multi-epitaxial planar technology for high switching speeds and medium voltage capability.

The STD830CP40 is housed in dual island DIP-8 package with separated terminals for higher assembly flexibility, specifically recommended to be used in a new solution for compact fluorescent lamp (CFL).

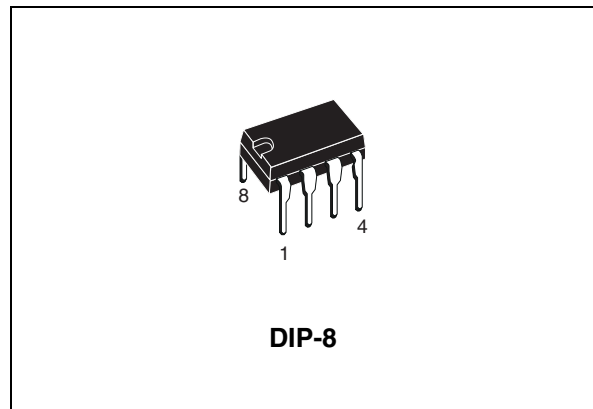

Figure 1. Internal schematic diagram

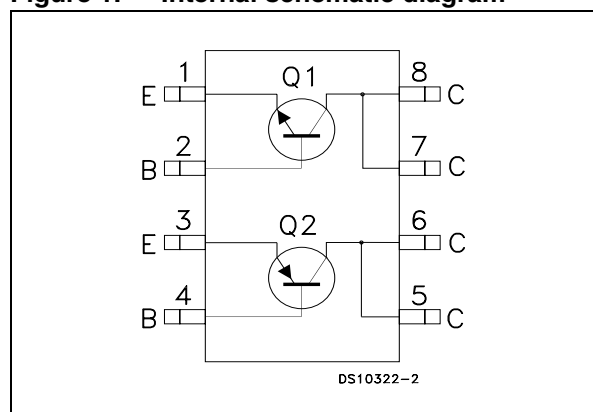

Table 1. Device summary

Order code	Marking	Package	Packing
STD830CP40	D830CP40	DIP-8	Tube

1 Electrical ratings

Table 2. Absolute maximum ratings

Symbol	Parameter	Value		Unit
		NPN	PNP	
V_{CBO}	Collector-base voltage ($I_E = 0$)	700	500	V
V_{CEO}	Collector-emitter voltage ($I_B = 0$)	400		V
V_{EBO}	Emitter-base voltage ($I_C = 0, I_B = 1.5 \text{ A}, t_p < 10 \text{ ms}$)	$V_{(BR)EBO}$		V
I_C	Collector current	3		A
I_{CM}	Collector peak current ($t_p < 5 \text{ ms}$)	6		A
I_B	Base current	1.5		A
I_{BM}	Base peak current ($t_p < 1 \text{ ms}$)	3		A
P_{TOT}	Total dissipation at $T_{amb} = 25 \text{ °C}$ single transistor	3		W
P_{TOT}	Total dissipation at $T_{amb} = 25 \text{ °C}$ both transistors	2.2		W
T_{STG}	Storage temperature	-65 to 150		°C
T_J	Max. operating junction temperature	150		°C

Table 3. Thermal data

Symbol	Parameter	Value	Unit
$R_{thJA}^{(1)}$	Thermal resistance junction-ambient (Single transistor)	42	°C/W
$R_{thJA}^{(1)}$	Thermal resistance junction-ambient (Both transistors)	57	°C/W

1. When mounted on 25mm square pad of 2 oz. copper, $t \leq 10 \text{ sec}$.

Note: For PNP types voltage and current values are negative

2 Electrical characteristics

$T_{\text{case}} = 25\text{ }^{\circ}\text{C}$ unless otherwise specified.

Table 4. Electrical characteristics

Symbol	Parameter	Test conditions	Min.	Typ.	Max.	Unit
I_{CES}	Collector cut-off current ($V_{\text{BE}} = 0$)	For NPN: $V_{\text{CE}} = 700\text{ V}$ $V_{\text{CE}} = 700\text{ V}$ $T_{\text{C}} = 125^{\circ}\text{C}$			0.1 0.5	mA mA
		For PNP: $V_{\text{CE}} = 500\text{ V}$ $V_{\text{CE}} = 500\text{ V}$ $T_{\text{C}} = 125^{\circ}\text{C}$			0.1 0.5	mA mA
$V_{(\text{BR})\text{EBO}}$	Emitter-base breakdown voltage ($I_{\text{C}} = 0$)	$I_{\text{E}} = 10\text{ mA}$ For NPN: For PNP:	10 5		18 10	V V
$V_{\text{CEO(sus)}}^{(1)}$	Collector-emitter sustaining voltage ($I_{\text{B}} = 0$)	$I_{\text{C}} = 5\text{ mA}$	400			V
$V_{\text{CE(sat)}}^{(1)}$	Collector-emitter saturation voltage	$I_{\text{C}} = 0.7\text{ A}$ $I_{\text{B}} = 0.1\text{ A}$			0.5	V
		$I_{\text{C}} = 1\text{ A}$ $I_{\text{B}} = 0.2\text{ A}$			0.5	V
$V_{\text{BE(sat)}}^{(1)}$	Base-emitter saturation voltage	$I_{\text{C}} = 0.5\text{ A}$ $I_{\text{B}} = 0.1\text{ A}$			1.1	V
		$I_{\text{C}} = 1\text{ A}$ $I_{\text{B}} = 0.2\text{ A}$			1.2	V
$h_{\text{FE}}^{(1)}$	DC current gain	$I_{\text{C}} = 10\text{ mA}$ $V_{\text{CE}} = 5\text{ V}$	10			
		$I_{\text{C}} = 0.7\text{ A}$ $V_{\text{CE}} = 5\text{ V}$	18		34	
		$I_{\text{C}} = 2\text{ A}$ $V_{\text{CE}} = 5\text{ V}$	4			
t_{r} t_{s} t_{f}	Resistive load					
	Rise time	$I_{\text{C}} = 0.7\text{ A}$ $V_{\text{CC}} = 250\text{ V}$		100		ns
	Storage time	$I_{\text{B1}} = 0.14\text{ A}$ $I_{\text{B2}} = -0.14\text{ A}$		2.4		μs
t_{f}	Fall time	$t_{\text{p}} = 30\text{ }\mu\text{s}$		100		ns
t_{s} t_{f}	Inductive load					
	Storage time	$I_{\text{C}} = 1\text{ A}$ $I_{\text{B1}} = 0.2\text{ A}$ $V_{\text{BE(off)}} = -5\text{ V}$ $R_{\text{BB}} = 0$		450		ns
	Fall time	$V_{\text{clamp}} = 200\text{ V}$ $L = 1\text{ mH}$		100		ns

1. Pulse test: pulse duration $\leq 300\text{ }\mu\text{s}$, duty cycle $\leq 2\%$.

Note: For PNP types voltage and current values are negative

2.1 Electrical characteristics (curves)

Figure 2. Safe operating area

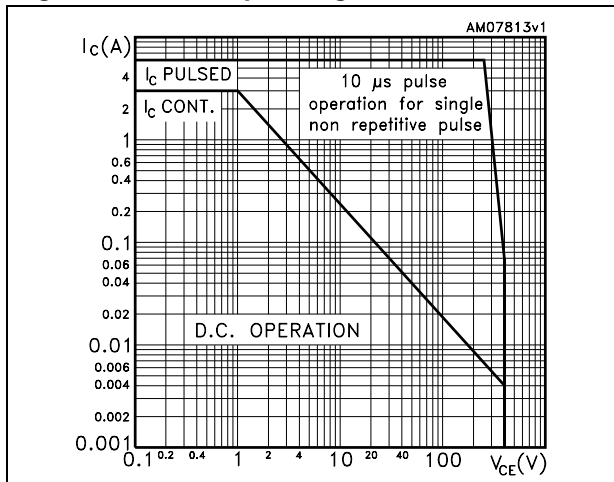

Figure 3. Derating curve

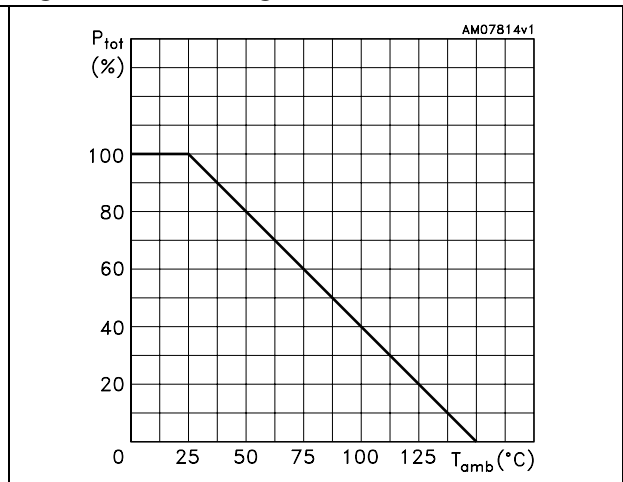

Figure 4. DC current gain NPN ($V_{CE} = 5\text{ V}$)

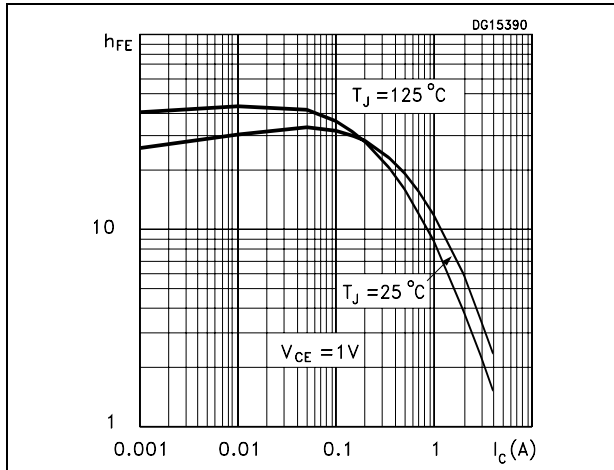

Figure 5. DC current gain PNP ($V_{CE} = -5\text{ V}$)

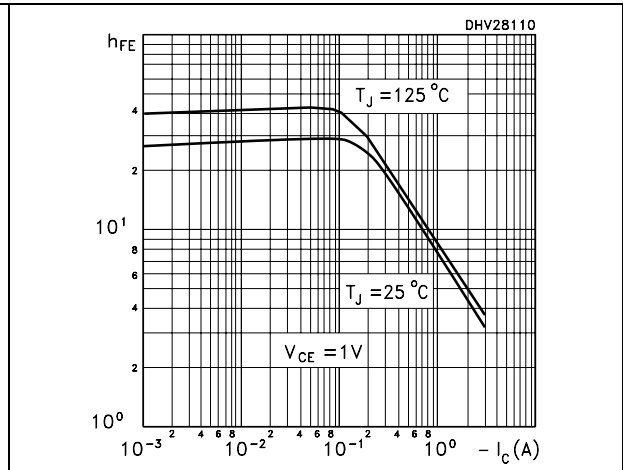

Figure 6. DC current gain NPN ($V_{CE} = 1\text{ V}$)

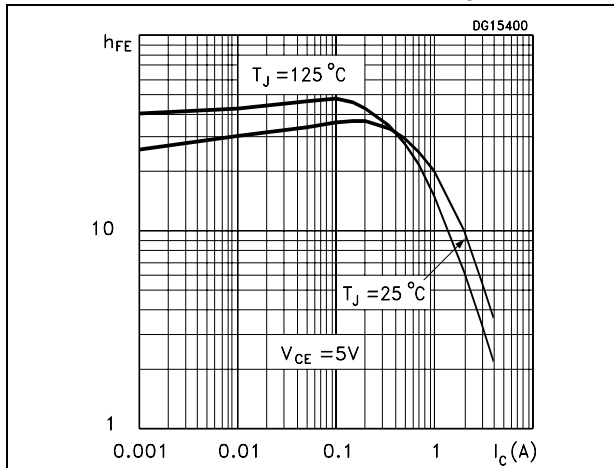

Figure 7. DC current gain PNP ($V_{CE} = -1\text{ V}$)

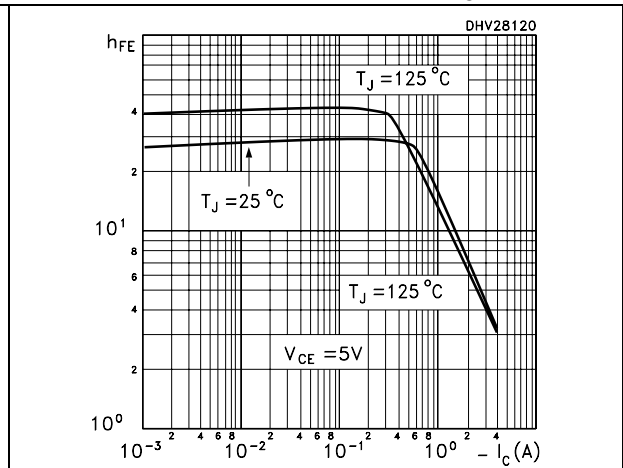

Figure 8. Collector emitter saturation voltage NPN

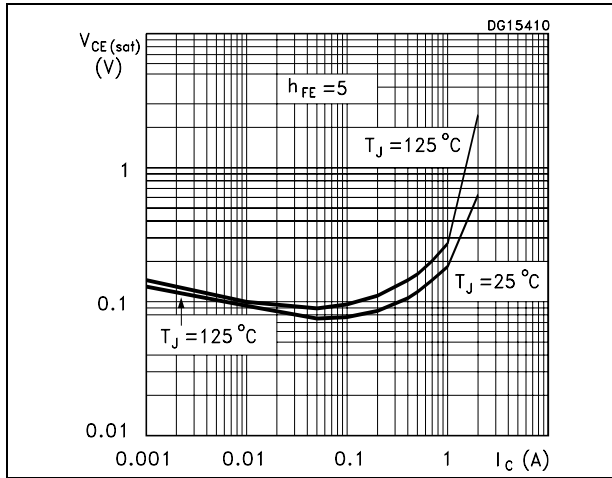

Figure 9. Collector emitter saturation voltage PNP

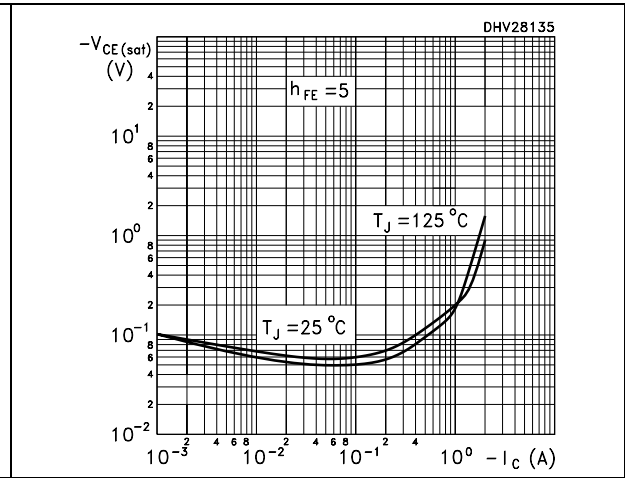

Figure 10. Base emitter saturation voltage NPN

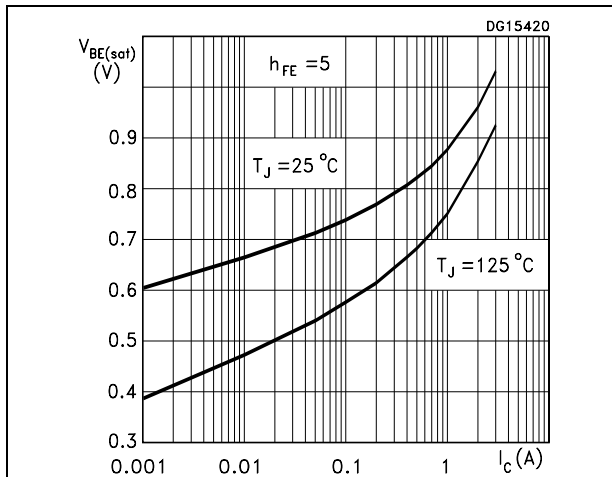

Figure 11. Base emitter saturation voltage PNP

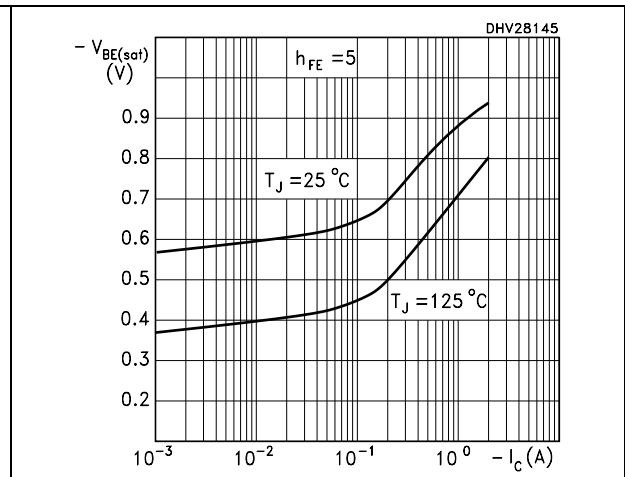

Figure 12. Resistive load fall time NPN

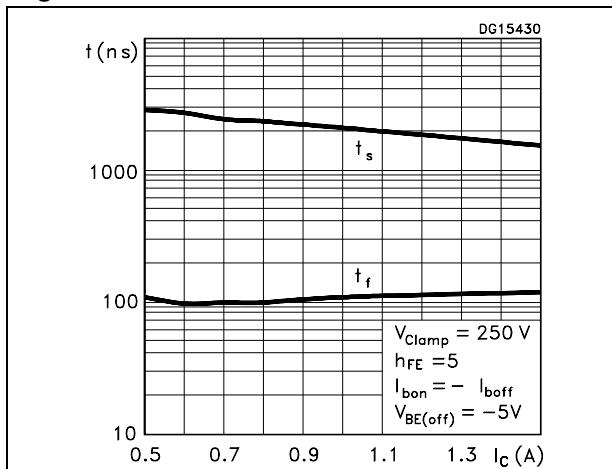

Figure 13. Resistive load fall time PNP

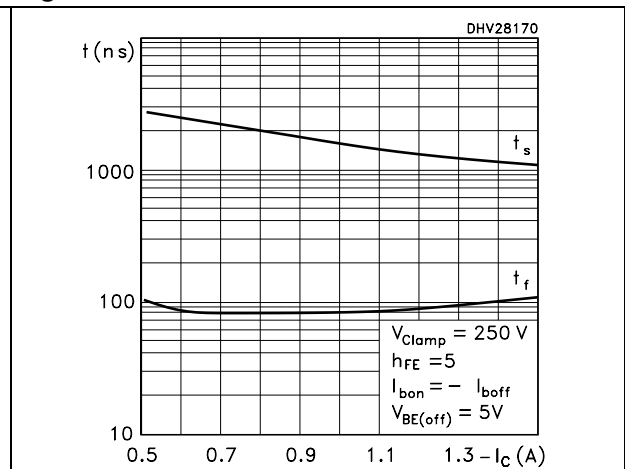

Figure 14. Resistive load storage time NPN

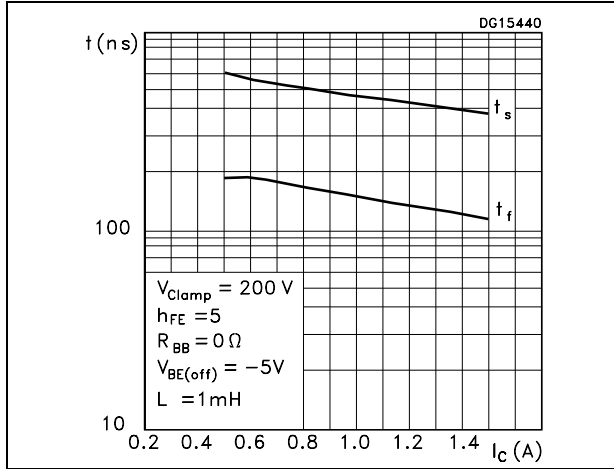

Figure 15. Resistive load storage time PNP

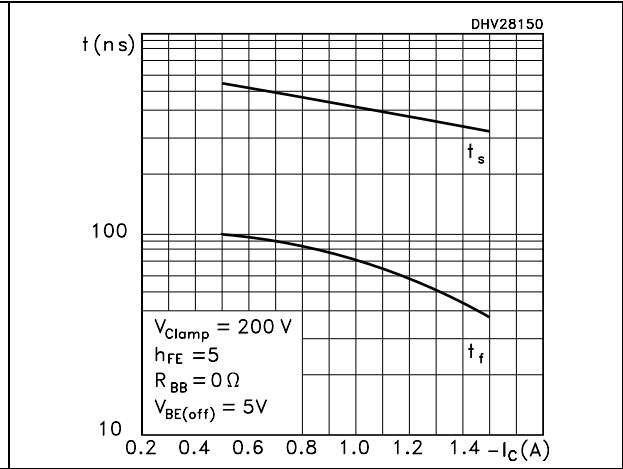

Figure 16. Reverse biased SOA (NPN)

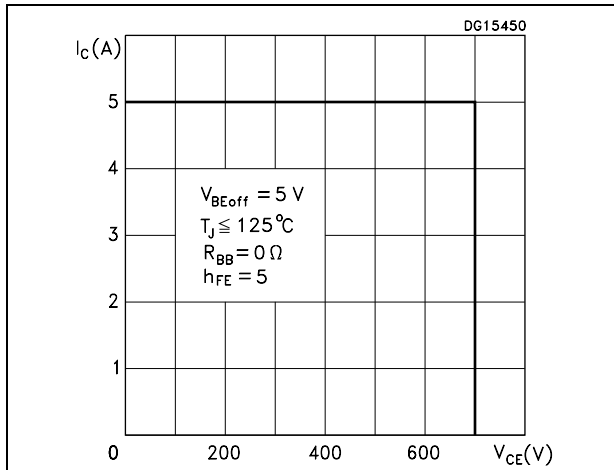
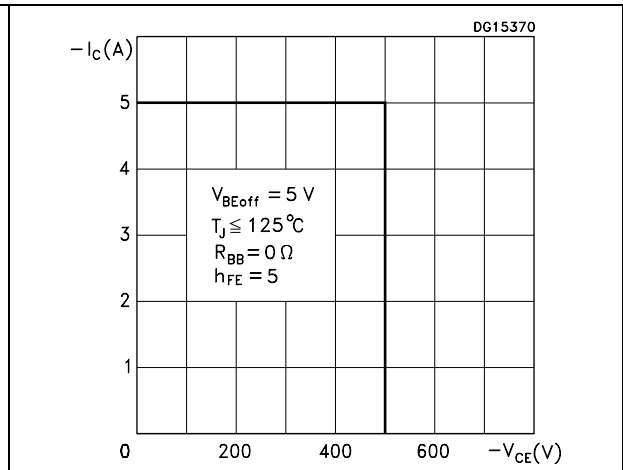

Figure 17. Reverse biased SOA (PNP)



3 Package mechanical data

In order to meet environmental requirements, ST offers these devices in different grades of ECOPACK[®] packages, depending on their level of environmental compliance. ECOPACK[®] specifications, grade definitions and product status are available at: www.st.com. ECOPACK[®] is an ST trademark.

Table 5. DIP-8 mechanical data

Dim.	mm.		
	Min.	Typ.	Max.
A			4.80
A1	0.50		
A2	3.10		3.50
A3	1.40		1.60
b	0.38		0.55
b1	0.38		0.51
b2	1.47		1.57
b3	0.89		1.09
c	0.21		0.35
c1	0.20		0.30
D	9.10		9.30
D1	0.13		
E	7.62		8.25
E1	6.25		6.45
e		2.54	
eA		7.62	
eB	7.62		10.90
eC	0		1.52
L	2.92		3.81

Figure 18. Drawing dimension DIP-8

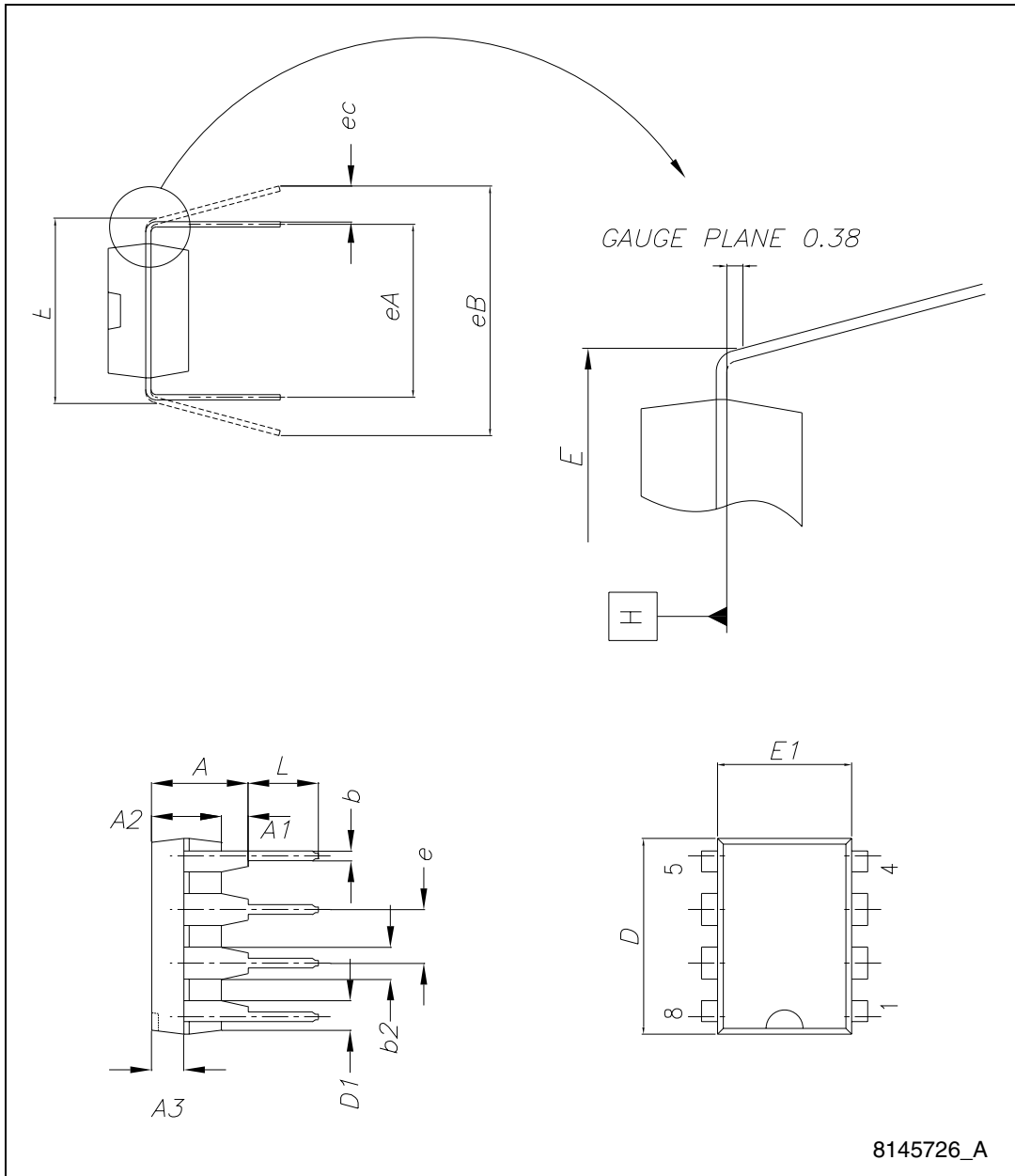

8145726_A

4 Revision history

Table 6. Document revision history

Date	Revision	Changes
27-May-2009	1	Initial release.
29-Jun-2010	2	Modified: <i>Table 2</i> and <i>Table 3 on page 2</i> , added <i>Section 2.1: Electrical characteristics (curves)</i> .

Please Read Carefully:

Information in this document is provided solely in connection with ST products. STMicroelectronics NV and its subsidiaries ("ST") reserve the right to make changes, corrections, modifications or improvements, to this document, and the products and services described herein at any time, without notice.

All ST products are sold pursuant to ST's terms and conditions of sale.

Purchasers are solely responsible for the choice, selection and use of the ST products and services described herein, and ST assumes no liability whatsoever relating to the choice, selection or use of the ST products and services described herein.

No license, express or implied, by estoppel or otherwise, to any intellectual property rights is granted under this document. If any part of this document refers to any third party products or services it shall not be deemed a license grant by ST for the use of such third party products or services, or any intellectual property contained therein or considered as a warranty covering the use in any manner whatsoever of such third party products or services or any intellectual property contained therein.

UNLESS OTHERWISE SET FORTH IN ST'S TERMS AND CONDITIONS OF SALE ST DISCLAIMS ANY EXPRESS OR IMPLIED WARRANTY WITH RESPECT TO THE USE AND/OR SALE OF ST PRODUCTS INCLUDING WITHOUT LIMITATION IMPLIED WARRANTIES OF MERCHANTABILITY, FITNESS FOR A PARTICULAR PURPOSE (AND THEIR EQUIVALENTS UNDER THE LAWS OF ANY JURISDICTION), OR INFRINGEMENT OF ANY PATENT, COPYRIGHT OR OTHER INTELLECTUAL PROPERTY RIGHT.

UNLESS EXPRESSLY APPROVED IN WRITING BY AN AUTHORIZED ST REPRESENTATIVE, ST PRODUCTS ARE NOT RECOMMENDED, AUTHORIZED OR WARRANTED FOR USE IN MILITARY, AIR CRAFT, SPACE, LIFE SAVING, OR LIFE SUSTAINING APPLICATIONS, NOR IN PRODUCTS OR SYSTEMS WHERE FAILURE OR MALFUNCTION MAY RESULT IN PERSONAL INJURY, DEATH, OR SEVERE PROPERTY OR ENVIRONMENTAL DAMAGE. ST PRODUCTS WHICH ARE NOT SPECIFIED AS "AUTOMOTIVE GRADE" MAY ONLY BE USED IN AUTOMOTIVE APPLICATIONS AT USER'S OWN RISK.

Resale of ST products with provisions different from the statements and/or technical features set forth in this document shall immediately void any warranty granted by ST for the ST product or service described herein and shall not create or extend in any manner whatsoever, any liability of ST.

ST and the ST logo are trademarks or registered trademarks of ST in various countries.

Information in this document supersedes and replaces all information previously supplied.

The ST logo is a registered trademark of STMicroelectronics. All other names are the property of their respective owners.

© 2010 STMicroelectronics - All rights reserved

STMicroelectronics group of companies

Australia - Belgium - Brazil - Canada - China - Czech Republic - Finland - France - Germany - Hong Kong - India - Israel - Italy - Japan - Malaysia - Malta - Morocco - Philippines - Singapore - Spain - Sweden - Switzerland - United Kingdom - United States of America

www.st.com