

## Transil™ array for ESD protection

### Features

- 5 unidirectional Transil functions
- Minimum breakdown voltage range:  
V<sub>BR</sub> min. = 17 V
- Peak pulse power (8/20 μs); 150 W
- Tiny leakage current at stand-off voltage:  
< 100 nA

### Benefits

- High ESD protection level
- High integration
- Suitable for high density boards

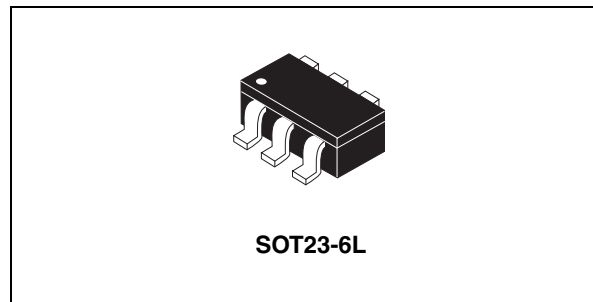
### Complies with the following standards:

- IEC 61000-4-2 level 4:
  - 15 kV (air discharge)
  - 8 kV (contact discharge)
- MIL STD 883E- Method 3015-7: class 3
  - 25 kV (human body model)

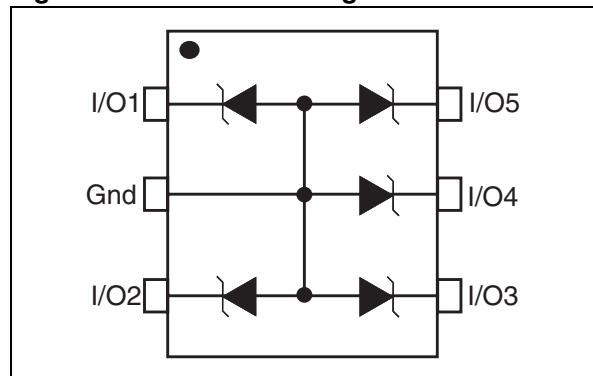
### Applications

Where transient overvoltage protection in ESD sensitive equipment is required, such as:

- Computers
- Printers and other peripherals
- Communications systems
- Cellular phone handsets and accessories
- Other telephone sets
- Consumer electronics (Set top boxes, DVD players, TV sets)



**Figure 1. Functional diagram**



### Description

The ESDA17-5SC6 is a monolithic array designed to protect up to 5 lines against ESD transients. The device is ideal for applications where board space saving is required.

**TM:** Transil is a trademark of STMicroelectronics

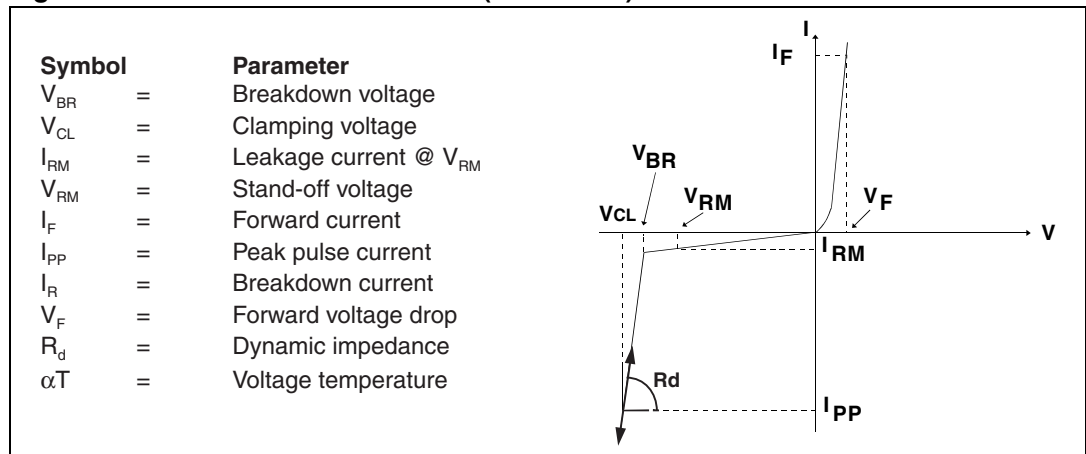
# 1 Characteristics

**Table 1. Absolute ratings ( $T_{amb} = 25\text{ }^{\circ}\text{C}$ )**

Symbol	Parameter		Value	Unit
$V_{PP}$	ESD discharge	IEC 61000-4-2 air discharge IEC 61000-4-2 contact discharge	$\pm 15$ $\pm 8$	kV
$P_{PP}$	Peak pulse power (8/20 $\mu$ s)	$T_j$ initial = $T_{amb}$	150	W
$T_j$	Junction temperature		125	$^{\circ}\text{C}$
$T_{stg}$	Storage temperature range		-55 to +150	$^{\circ}\text{C}$
$T_L$	Maximum lead temperature for soldering during 10 s at 5mm for case		260	$^{\circ}\text{C}$
$T_{op}$	Operating temperature range <sup>(1)</sup>		-40 to +125	$^{\circ}\text{C}$

1. For a surge greater than the maximum values, the diode will fail in short-circuit.

**Figure 2. Electrical characteristics (definitions)**



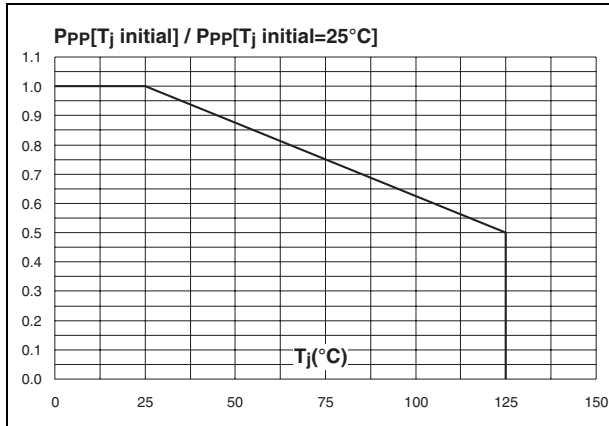
**Table 2. Electrical characteristics (values,  $T_{amb} = 25\text{ }^{\circ}\text{C}$ )**

Order code	$V_{BR} @ I_R$		$I_{RM} @ V_{RM}$		$R_d$ typ. <sup>(1)</sup> $\Omega$	$\alpha T$ max. <sup>(2)</sup> $10^{-4}/^{\circ}\text{C}$	C typ. 0V bias pF	$V_F @ I_F$		
	min. V	max. V	max. mA	max. V				max. V	max. mA	
ESDA17-5SC6	17	19	1	75	14	1	10	33	1.2	10

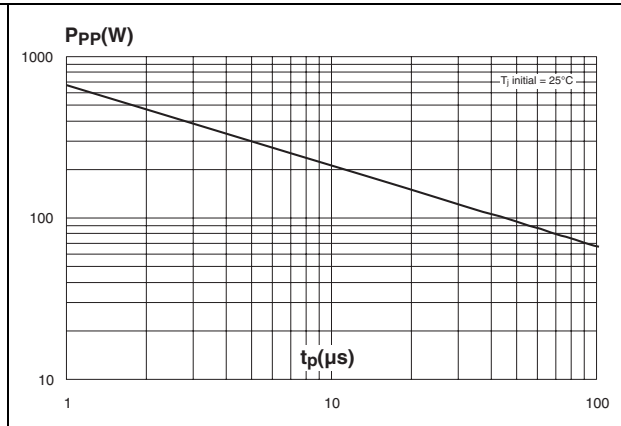
1. Square pulse,  $I_{pp} = 15\text{ A}$ ,  $t_p = 2.5\text{ }\mu\text{s}$ .

2.  $\Delta V_{BR} = \alpha T * (T_{amb} - 25\text{ }^{\circ}\text{C}) * V_{BR}(25\text{ }^{\circ}\text{C})$

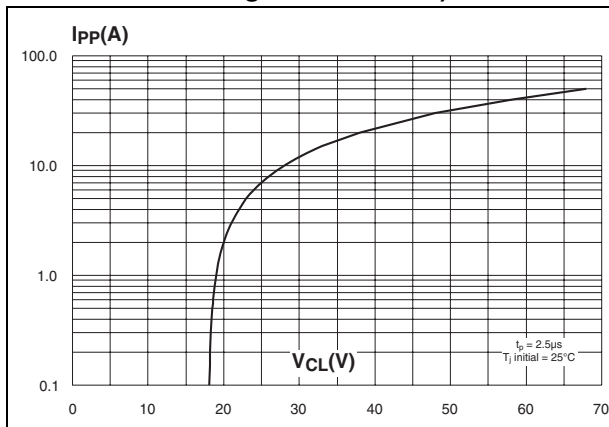
**Figure 3. Relative variation of peak pulse power versus initial junction temperature**



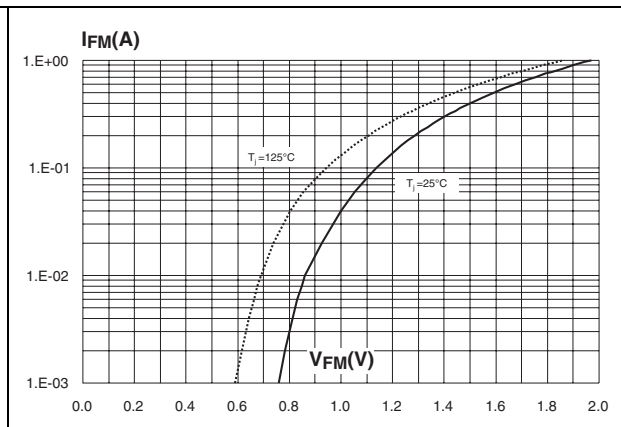
**Figure 4. Peak pulse power versus exponential pulse duration**



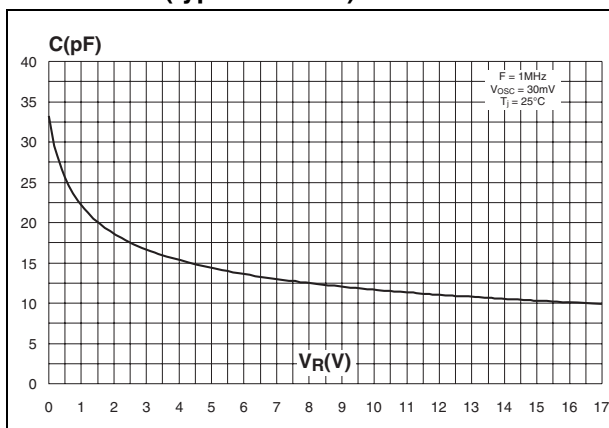
**Figure 5. Clamping voltage versus peak pulse current (typical values, rectangular waveform)**



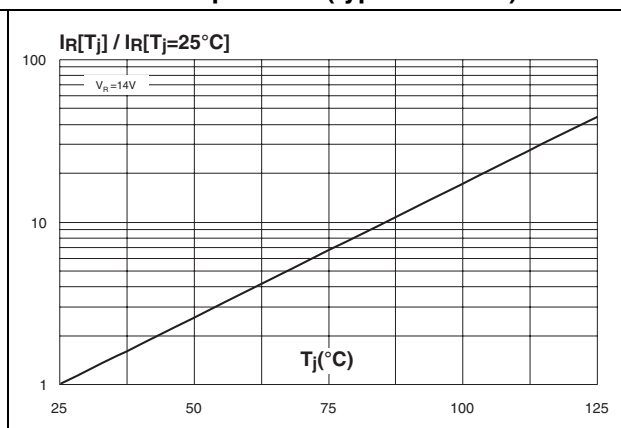
**Figure 6. Forward voltage drop versus peak forward current (typical values)**



**Figure 7. Junction capacitance versus reverse voltage applied (typical values)**

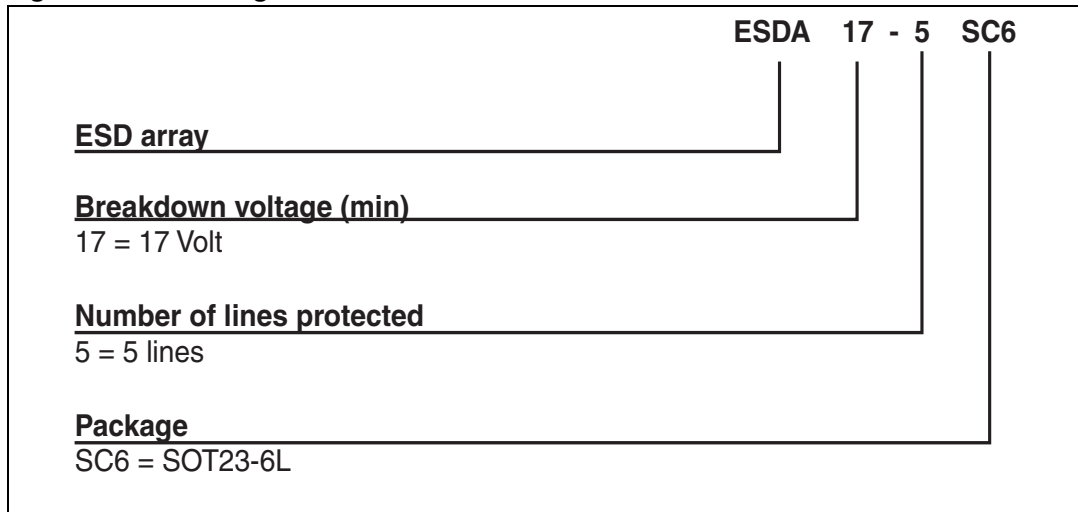


**Figure 8. Relative variation of leakage current versus junction temperature (typical values)**



## 2 Ordering information scheme

Figure 9. Ordering information scheme



### 3 Package information

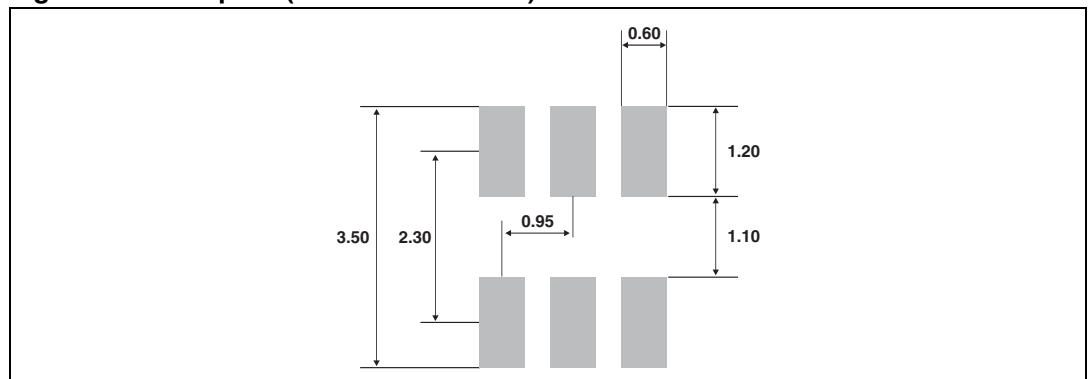
- Epoxy meets UL94, V0
- Lead-free package

In order to meet environmental requirements, ST offers these devices in different grades of ECOPACK® packages, depending on their level of environmental compliance. ECOPACK® specifications, grade definitions and product status are available at: [www.st.com](http://www.st.com). ECOPACK® is an ST trademark.

**Table 3. SOT23-6L dimensions**

Ref.	Dimensions					
	Millimeters			Inches		
	Min.	Typ.	Max.	Min.	Typ.	Max.
A	0.90		1.45	0.035		0.057
A1	0		0.10	0		0.004
A2	0.90		1.30	0.035		0.051
b	0.35		0.50	0.014		0.020
c	0.09		0.20	0.004		0.008
D	2.80		3.05	0.11		0.118
E	1.50		1.75	0.059		0.069
e		0.95			0.037	
H	2.60		3.00	0.102		0.118
L	0.10		0.60	0.004		0.024
θ	0°		10°	0°		10°

**Figure 10. Footprint (dimensions in mm)**



## 4 Ordering information

**Table 4. Ordering information**

Order code	Marking	Package	Weight	Base qty	Delivery mode
ESDA17-5SC6	175	SOT23-6L	16.7 mg	3000	Tape and reel

## 5 Revision history

**Table 5. Document revision history**

Date	Revision	Changes
Nov-2002	1A	First issue.
4-Nov-2004	2	SOT23-6L package dimensions change for reference "D" from 3.0 millimeters (0.118 inches) to 3.05 millimeters (0.120 inches).
14-Sep-2011	3	Removed all references to order code ESDA19-5SC6.

**Please Read Carefully:**

Information in this document is provided solely in connection with ST products. STMicroelectronics NV and its subsidiaries ("ST") reserve the right to make changes, corrections, modifications or improvements, to this document, and the products and services described herein at any time, without notice.

All ST products are sold pursuant to ST's terms and conditions of sale.

Purchasers are solely responsible for the choice, selection and use of the ST products and services described herein, and ST assumes no liability whatsoever relating to the choice, selection or use of the ST products and services described herein.

No license, express or implied, by estoppel or otherwise, to any intellectual property rights is granted under this document. If any part of this document refers to any third party products or services it shall not be deemed a license grant by ST for the use of such third party products or services, or any intellectual property contained therein or considered as a warranty covering the use in any manner whatsoever of such third party products or services or any intellectual property contained therein.

**UNLESS OTHERWISE SET FORTH IN ST'S TERMS AND CONDITIONS OF SALE ST DISCLAIMS ANY EXPRESS OR IMPLIED WARRANTY WITH RESPECT TO THE USE AND/OR SALE OF ST PRODUCTS INCLUDING WITHOUT LIMITATION IMPLIED WARRANTIES OF MERCHANTABILITY, FITNESS FOR A PARTICULAR PURPOSE (AND THEIR EQUIVALENTS UNDER THE LAWS OF ANY JURISDICTION), OR INFRINGEMENT OF ANY PATENT, COPYRIGHT OR OTHER INTELLECTUAL PROPERTY RIGHT.**

**UNLESS EXPRESSLY APPROVED IN WRITING BY TWO AUTHORIZED ST REPRESENTATIVES, ST PRODUCTS ARE NOT RECOMMENDED, AUTHORIZED OR WARRANTED FOR USE IN MILITARY, AIR CRAFT, SPACE, LIFE SAVING, OR LIFE SUSTAINING APPLICATIONS, NOR IN PRODUCTS OR SYSTEMS WHERE FAILURE OR MALFUNCTION MAY RESULT IN PERSONAL INJURY, DEATH, OR SEVERE PROPERTY OR ENVIRONMENTAL DAMAGE. ST PRODUCTS WHICH ARE NOT SPECIFIED AS "AUTOMOTIVE GRADE" MAY ONLY BE USED IN AUTOMOTIVE APPLICATIONS AT USER'S OWN RISK.**

Resale of ST products with provisions different from the statements and/or technical features set forth in this document shall immediately void any warranty granted by ST for the ST product or service described herein and shall not create or extend in any manner whatsoever, any liability of ST.

ST and the ST logo are trademarks or registered trademarks of ST in various countries.

Information in this document supersedes and replaces all information previously supplied.

The ST logo is a registered trademark of STMicroelectronics. All other names are the property of their respective owners.

© 2011 STMicroelectronics - All rights reserved

STMicroelectronics group of companies

Australia - Belgium - Brazil - Canada - China - Czech Republic - Finland - France - Germany - Hong Kong - India - Israel - Italy - Japan - Malaysia - Malta - Morocco - Philippines - Singapore - Spain - Sweden - Switzerland - United Kingdom - United States of America

[www.st.com](http://www.st.com)