

V _{RSM}	V _{RRM} V _{DRM}	(dv/dt) _{cr}	I _T RMS (maximum values for continuous operation)		
			110 A	135 A	175 A
V	V	V/μs	I _{TAV} (sin. 180; T _{case} = 80 °C)		
			70 A	86 A	110 A
500	400	500	SKT 55/04 D	–	SKT 100/04 D
700	600	500	SKT 55/06 D	SKT 80/06 D*	SKT 100/06 D*
900	800	500	SKT 55/08 D	SKT 80/08 D	SKT 100/08 D
1300	1200	1000	SKT 55/12 E	SKT 80/12 E*	SKT 100/12 E*
1500	1400	1000	SKT 55/14 E	SKT 80/14 E	SKT 100/14 E*
1700	1600	1000	SKT 55/16 E	SKT 80/16 E*	SKT 100/16 E*
1900	1800	1000	SKT 55/18 E ↕	SKT 80/18 E ↕	SKT 100/18 E ↕

Thyristors

SKT 55
SKT 80
SKT 100



Features

- Hermetic metal cases with ceramic insulators
- Threaded studs ISO M12 or UNF 1/2-20
- Interchangeable with international standard cases

Typical Applications

- DC motor control (e. g. for machine tools)
- Controlled rectifiers (e. g. for battery charging)
- AC controllers (e. g. for temperature control)

Symbol	Conditions	SKT 55	SKT 80	SKT 100	Units
I _{TAV}	sin. 180; (T _{case} = ... °C)	55 (92)	80 (85)	100 (85)	A °C
I _{TSM}	T _{vj} = 25 °C; 10 ms	1300	1700	2000	A
	T _{vj} = 130 °C; 10 ms	1100	1500	1750	A
i ² t	T _{vj} = 25 °C; 8,35 ... 10 ms	8 500	14 500	20 000	A ² s
	T _{vj} = 130 °C; 8,35 ... 10 ms	6 000	11 000	15 000	A ² s
t _{gd}	T _{vj} = 25 °C; I _G = 1 A; di _G /dt = 1 A/μs	typ. 1			μs
t _{gr}	V _D = 0,67 · V _{DRM}	typ. 2			μs
(di/dt) _{cr}	f = 50 ... 60 Hz	50			A/μs
I _H	T _{vj} = 25 °C	typ. 150; max. 250			mA
I _L	T _{vj} = 25 °C	typ. 300; max. 600			mA
t _q	T _{vj} = 130 °C; typ.	100			μs
V _T	T _{vj} = 25 °C; (I _T = ...); max.	1,8 (200)	2,25 (300)	1,75 (300)	V A
V _{T(TO)}	T _{vj} = 130 °C	0,9	1,2	1,0	V
r _T	T _{vj} = 130 °C	4	4	2,4	mΩ
I _{DD} , I _{RD}	T _{vj} = 130 °C; V _{DD} = V _{DRM} V _{RD} = V _{RRM}	25	30	30	mA
V _{GT}	T _{vj} = 25 °C	3			V
I _{GT}	T _{vj} = 25 °C	150			mA
V _{GD}	T _{vj} = 130 °C	0,25			V
I _{GD}	T _{vj} = 130 °C	10			mA
R _{thjc}	cont.	0,40	0,25		°C/W
	sin. 180/rec. 120	0,47/0,53	0,28/0,31		°C/W
R _{thch}		0,08			°C/W
T _{vj}		– 40 ... +130			°C
T _{stg}		– 55 ... +150			°C
M	SI units (US units)	10 (90 lb.in.)			Nm
a		5 · 9,81			m/s ²
w		65	80		g
Case		B 5			

* Available with UNF thread 1/2-20 UNF2A; e.g. SKT 80/06 D UNF

♦ available in limited quantities

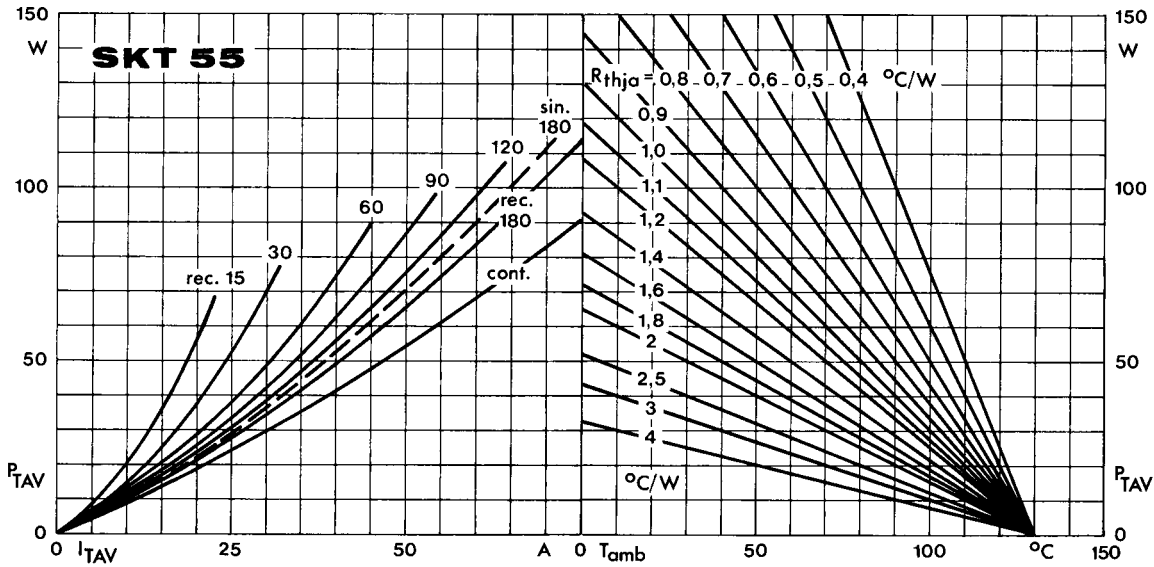

Fig. 1 a Power dissipation vs. on-state current and ambient temperature

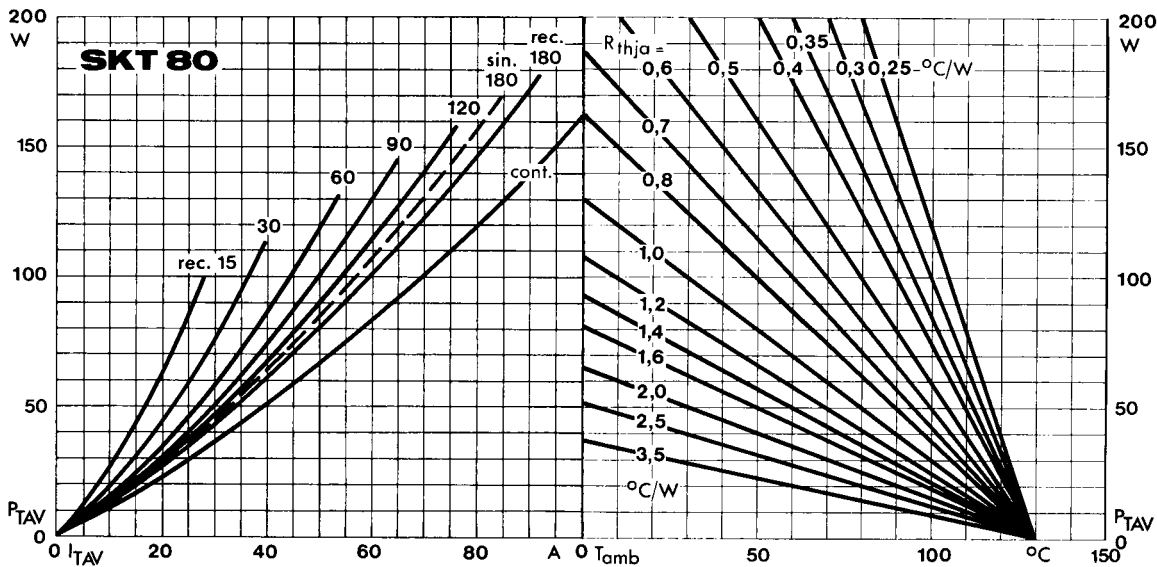

Fig. 1 b Power dissipation vs. on-state current and ambient temperature

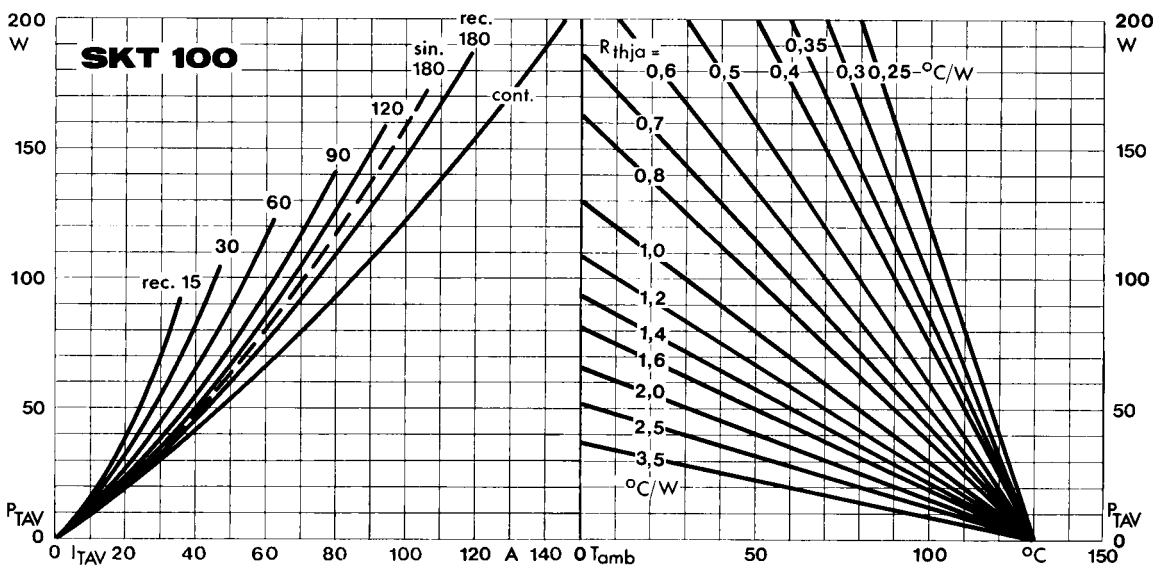

Fig. 1 c Power dissipation vs. on-state current and ambient temperature

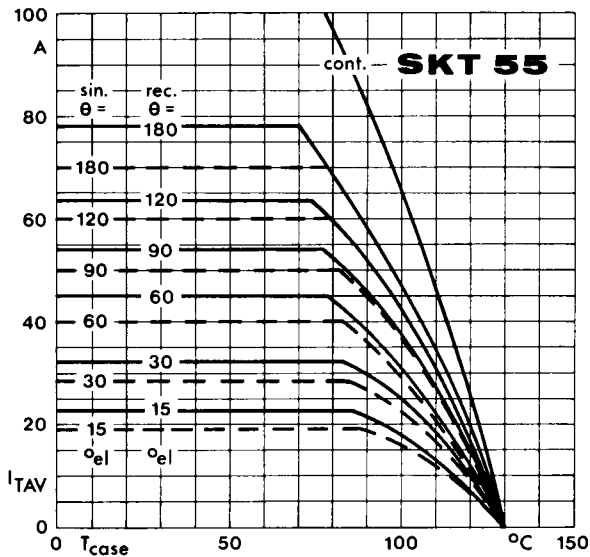

Fig. 2 a Rated on-state current vs. case temperature

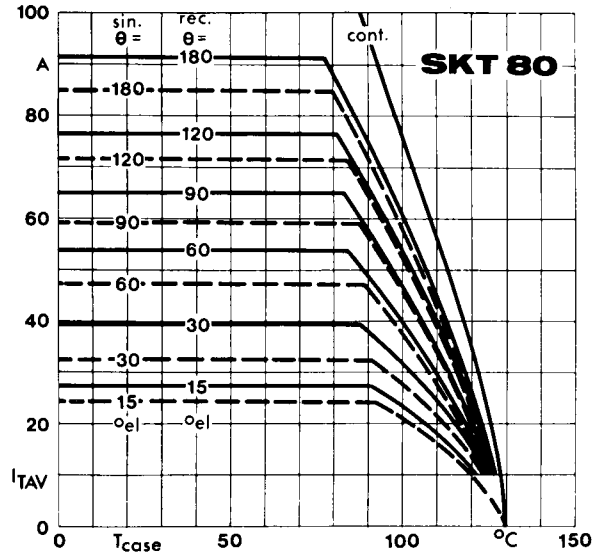

Fig. 2 b Rated on-state current vs. case temperature

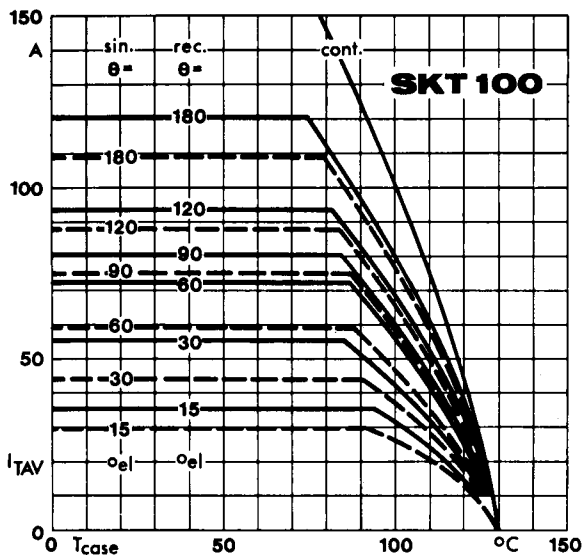

Fig. 2 c Rated on-state current vs. case temperature

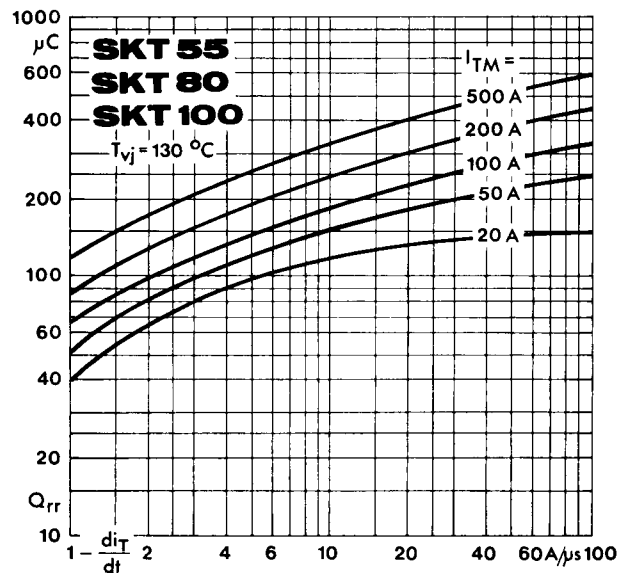

Fig. 3 Recovered charge vs. current decrease

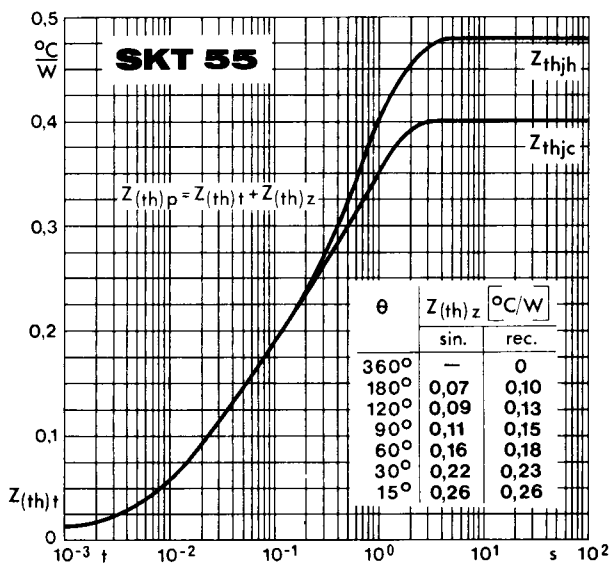

Fig. 4 a Transient thermal impedance vs. time

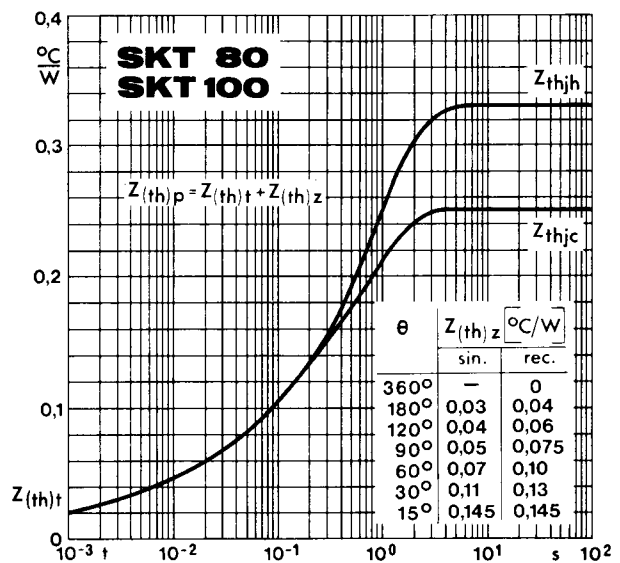

Fig. 4 b Transient thermal impedance vs. time

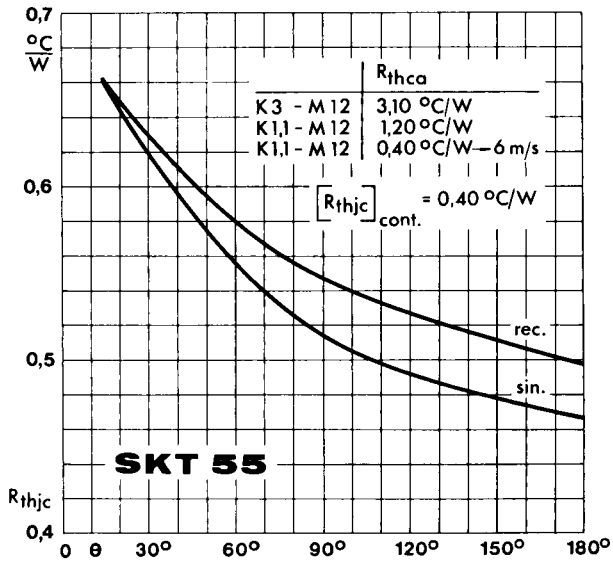

Fig. 5 a Thermal resistance vs. conduction angle

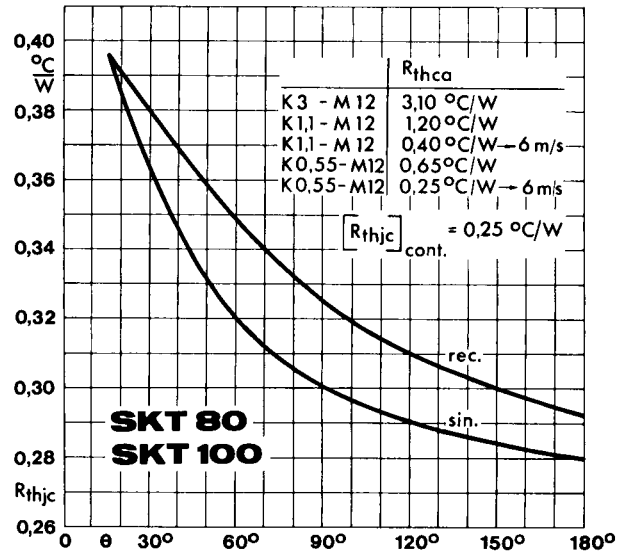

Fig. 5 b Thermal resistance vs. conduction angle

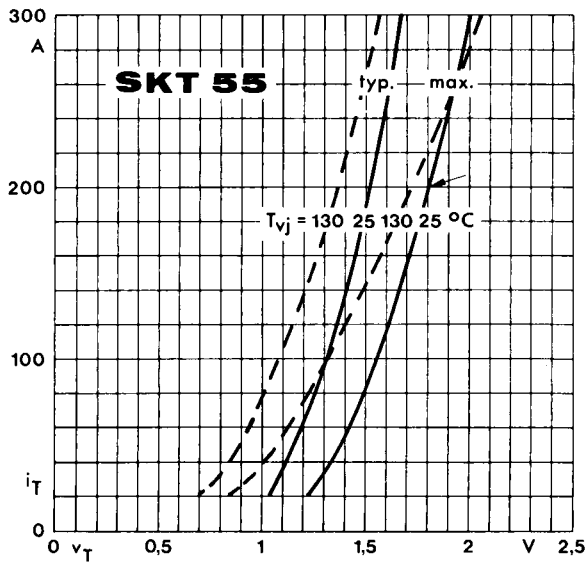

Fig. 6 a On-state characteristics

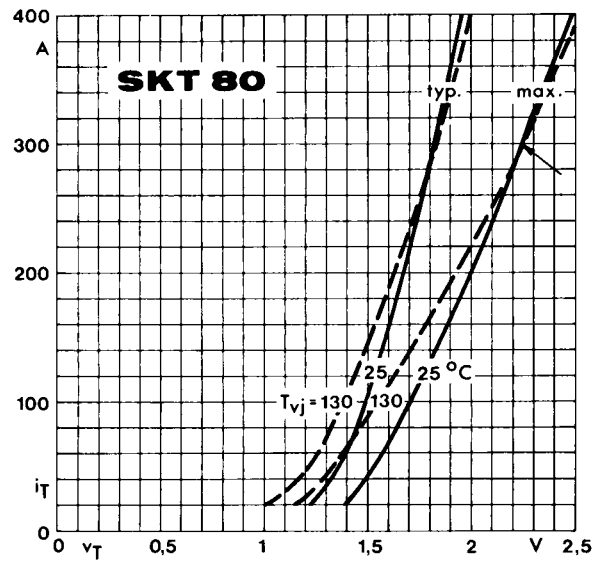

Fig. 6 b On-state characteristics

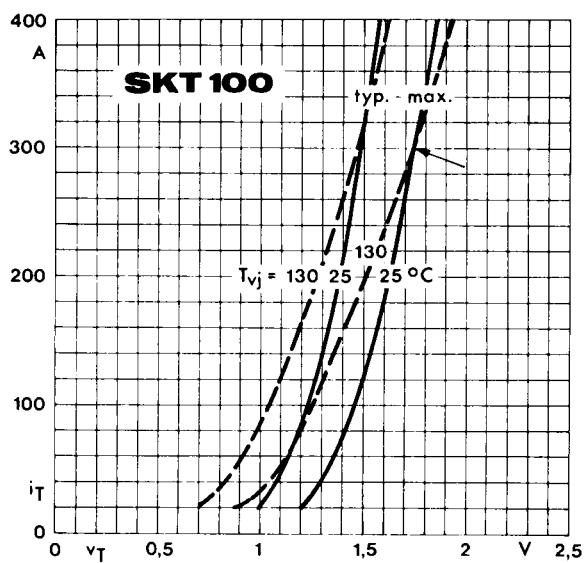

Fig. 6 c On-state characteristics

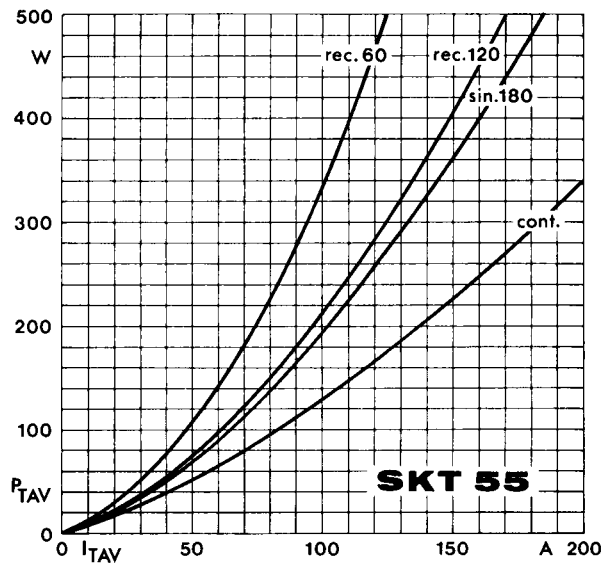

Fig. 7 a Power dissipation vs. on-state current

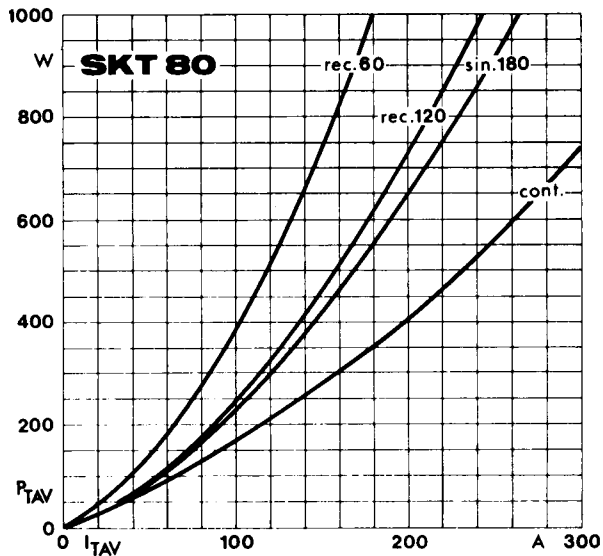

Fig. 7 b Power dissipation vs. on-state current

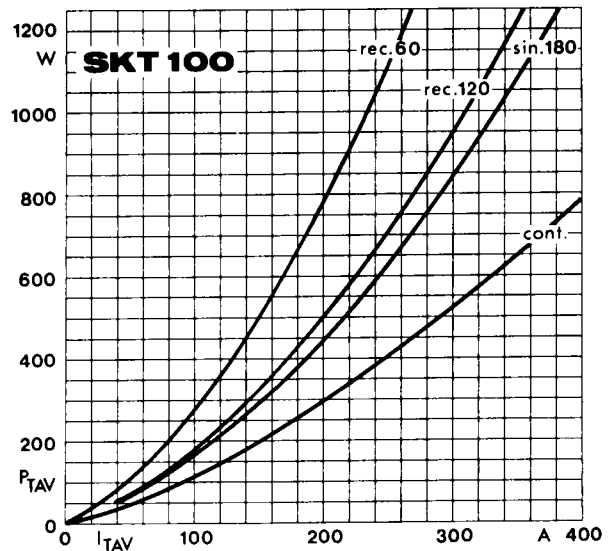

Fig. 7 c Power dissipation vs. on-state current

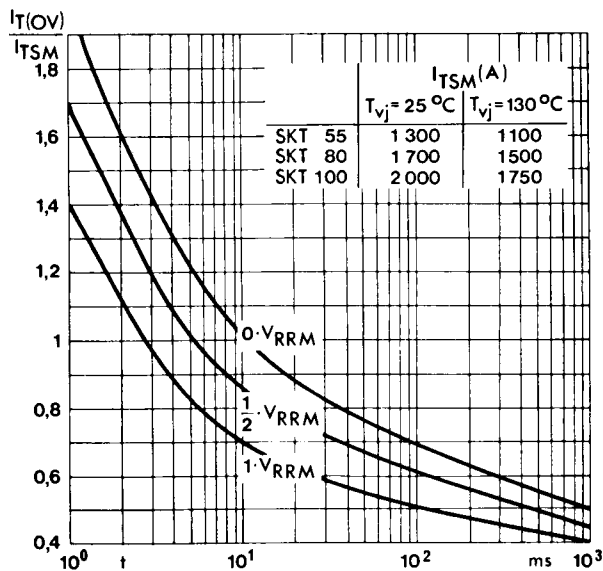

Fig. 8 Surge overload current vs. time

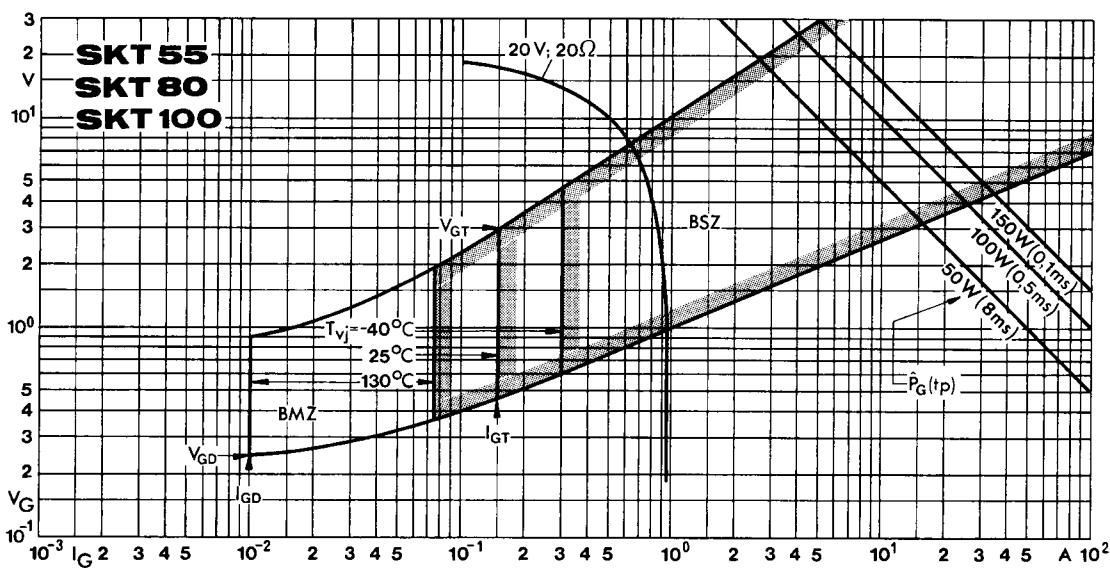

Fig. 9 Gate trigger characteristics

**SKT 55
SKT 80
SKT 100**

Case B 5

IEC-Publ. 191-2: (A 12 MA, A 12 U)

DIN 41892: (204 B 3)

BS 3934: SO – 30 C

JEDEC: TO – 209 (TO – 94)¹⁾

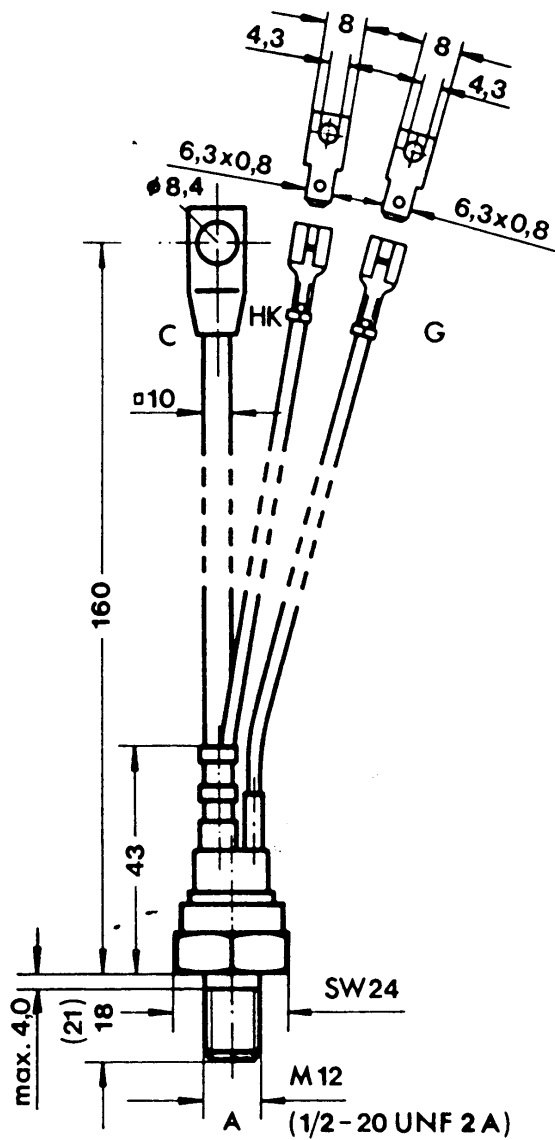

¹⁾ modified version. In the USA and Canada these types are available with the original TO-209 (TO-94) dimensions. TO-208 AD (TO-83) with flag terminals is also available.

**SKT 130
SKT 160**

Case B 6

IEC-Publ. 191-2: A 47 MC

DIN 41893: 205 B 4

JEDEC: TO-209 (TO-93)

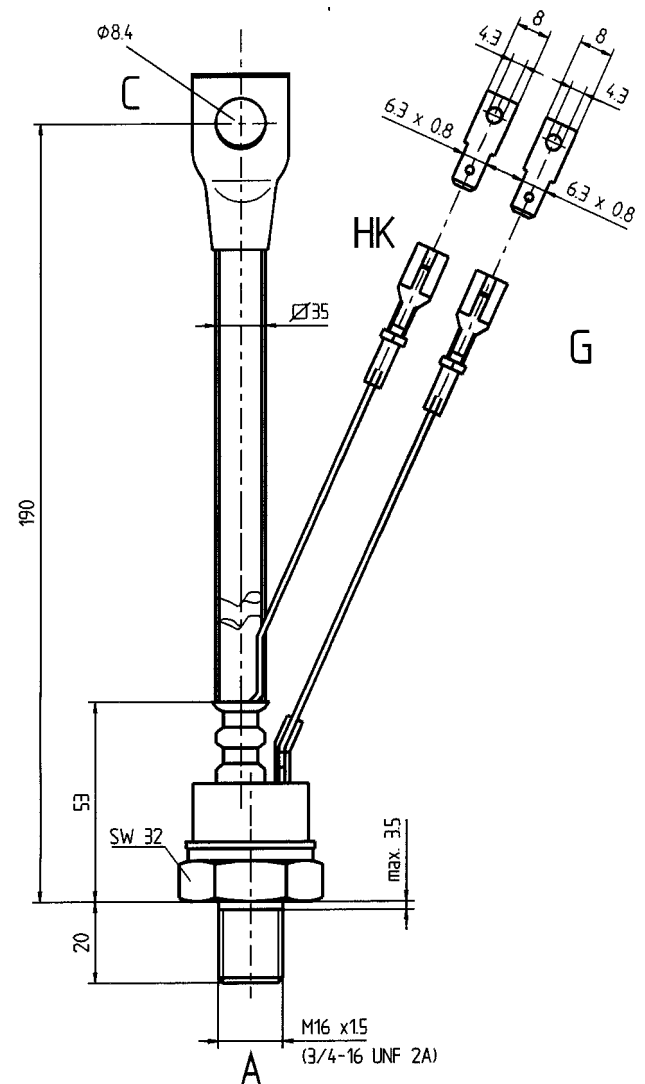

Dimensions in mm

- C: Cathode terminal (red sleeve)
- A: Anode terminal
- G: Gate terminal (yellow sleeve)
- HK: Auxiliary cathode terminal (red sleeve)