

SKT 100



Stud Thyristor

Line Thyristor

SKT 100

Features

- Hermetic metal case with glass insulator
- Threaded stud ISO M12 or UNF 1/2-20
- Interchangeable with international standard case

Typical Applications*

- DC motor control (e. g. for machines tools)
- Controlled rectifiers (e. g. for battery charging)
- AC controllers (e. g. for temperature control)
- Recommended snubber network e. g. for $V_{VRMS} \leq 400$ V:
 $R = 47 \Omega / 10$ W, $C = 0,22 \mu F$

1) Available with UNF thread 1/2-20 UNF2A, e. g. SKT 100/08D UNF

| V_{RSM} V | V_{RRM}, V_{DRM} V | $I_{TRMS} = 175$ A (maximum value for continuous operation) $I_{TAV} = 100$ A (sin. 180; $T_c = 85$ °C) | |
|----------------|-------------------------|--|--|
| 500 | 400 | SKT 100/04D | |
| 900 | 800 | SKT 100/08D ¹⁾ | |
| 1300 | 1200 | SKT 100/12E ¹⁾ | |
| 1500 | 1400 | SKT 100/14E ¹⁾ | |
| 1700 | 1600 | SKT 100/16E ¹⁾ | |
| 1900 | 1800 | SKT 100/18E | |

| Symbol | Conditions | Values | Units |
|------------------|---|-----------------------|------------------|
| I_{TAV} | sin. 180; $T_c = 100$ (85) °C; | 74 (100) | A |
| I_D | K1,1; $T_a = 45$ °C; B2 / B6 K0,55; $T_a = 45$ °C; B2 / B6 | 90 / 125 130 / 180 | A |
| I_{RMS} | K1,1; $T_a = 45$ °C; W1C | 100 | A |
| I_{TSM} | $T_{vj} = 25$ °C; 10 ms $T_{vj} = 130$ °C; 10 ms | 2000 1750 | A |
| i^2t | $T_{vj} = 25$ °C; 8,35 ... 10 ms $T_{vj} = 130$ °C; 8,35 ... 10 ms | 20000 15000 | A ² s |
| V_T | $T_{vj} = 25$ °C; $I_T = 300$ A | max. 1,75 | V |
| $V_{T(TO)}$ | $T_{vj} = 130$ °C | max. 1 | V |
| r_T | $T_{vj} = 130$ °C | max. 2,4 | mΩ |
| I_{DD}, I_{RD} | $T_{vj} = 130$ °C; $V_{RD} = V_{RRM}; V_{DD} = V_{DRM}$ | max. 30 | mA |
| t_{gd} | $T_{vj} = 25$ °C; $I_G = 1$ A; $di_G/dt = 1$ A/μs | 1 | μs |
| t_{gr} | $V_D = 0,67 * V_{DRM}$ | 2 | μs |
| $(di/dt)_{cr}$ | $T_{vj} = 130$ °C | max. 50 | A/μs |
| $(dv/dt)_{cr}$ | $T_{vj} = 130$ °C; SKT ...D / SKT ...E | max. 500 / 1000 | V/μs |
| t_q | $T_{vj} = 130$ °C, | 100 | μs |
| I_H | $T_{vj} = 25$ °C; typ. / max. | 150 / 250 | mA |
| I_L | $T_{vj} = 25$ °C; typ. / max. | 300 / 600 | mA |
| V_{GT} | $T_{vj} = 25$ °C; d.c. | min. 3 | V |
| I_{GT} | $T_{vj} = 25$ °C; d.c. | min. 150 | mA |
| V_{GD} | $T_{vj} = 130$ °C; d.c. | max. 0,25 | V |
| I_{GD} | $T_{vj} = 130$ °C; d.c. | max. 10 | mA |
| $R_{th(j-c)}$ | cont. | 0,25 | K/W |
| $R_{th(j-c)}$ | sin. 180 | 0,28 | K/W |
| $R_{th(j-c)}$ | rec. 120 | 0,31 | K/W |
| $R_{th(c-s)}$ | | 0,08 | K/W |
| T_{vj} | | - 40 ... + 130 | °C |
| T_{stg} | | - 55 ... + 150 | °C |
| V_{isol} | | - | V~ |
| M_s | to heatsink | 16 | Nm |
| a | | 5 * 9,81 | m/s ² |
| m | approx. | 100 | g |
| Case | | B 5 | |



SKT

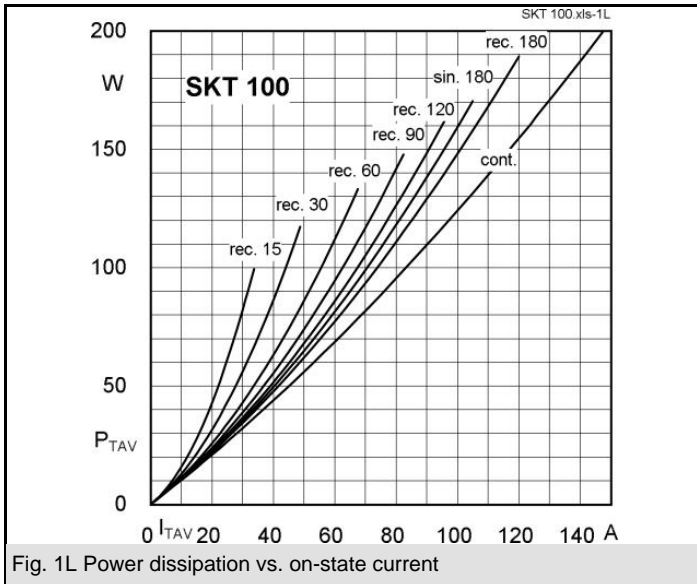

Fig. 1L Power dissipation vs. on-state current

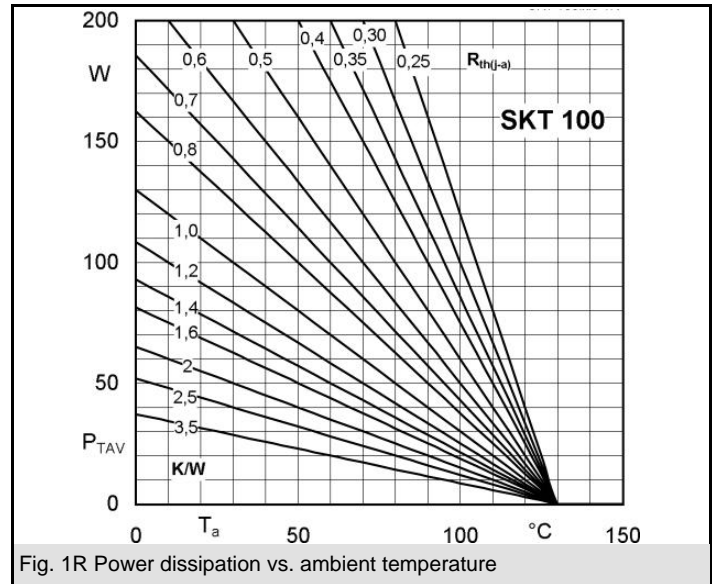

Fig. 1R Power dissipation vs. ambient temperature

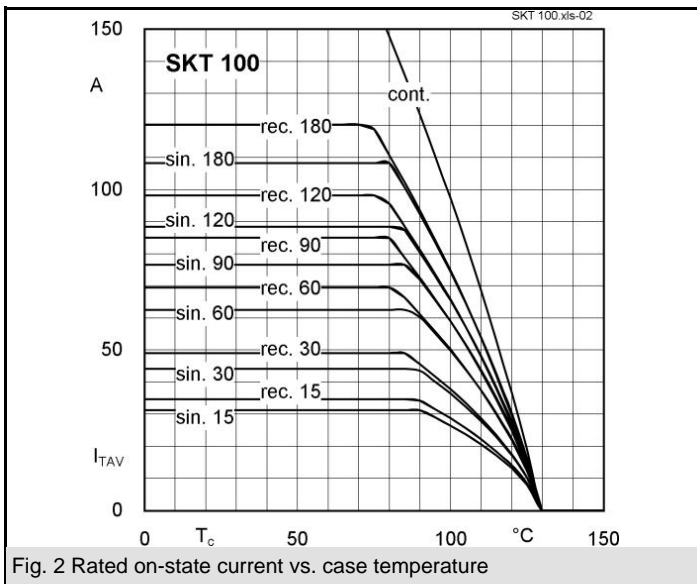

Fig. 2 Rated on-state current vs. case temperature

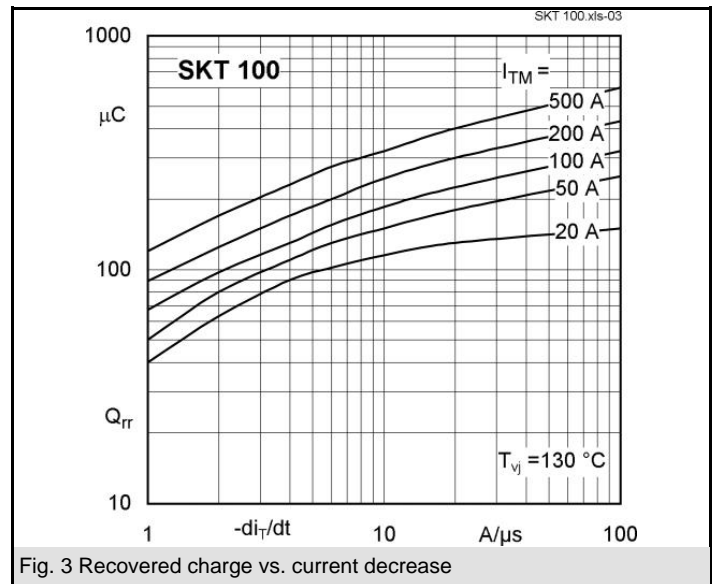

Fig. 3 Recovered charge vs. current decrease

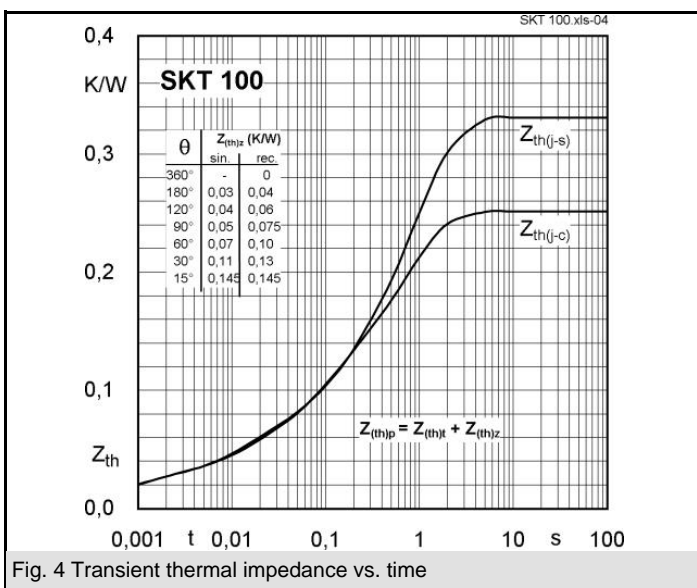

Fig. 4 Transient thermal impedance vs. time

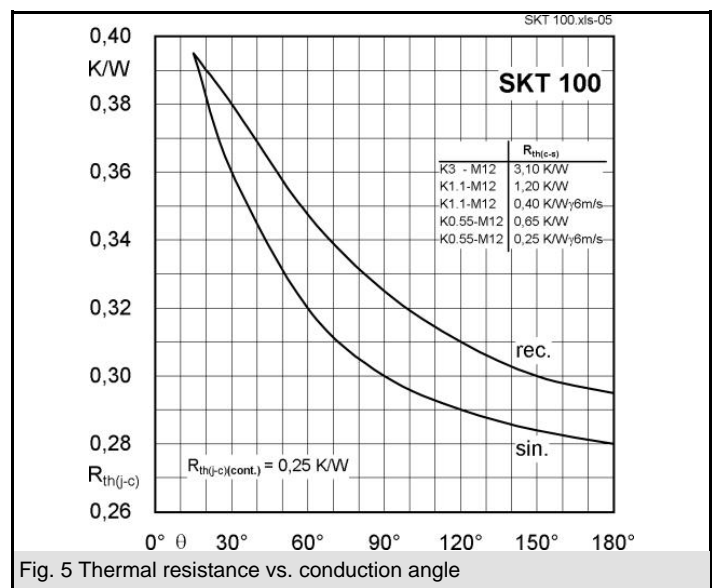
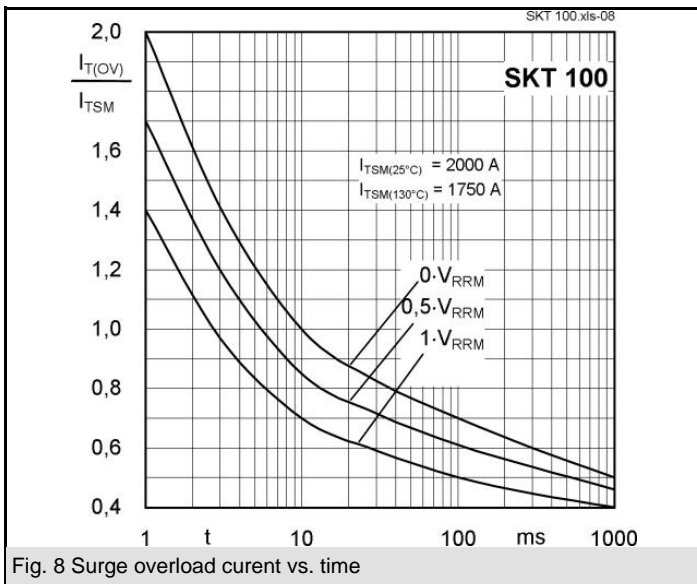
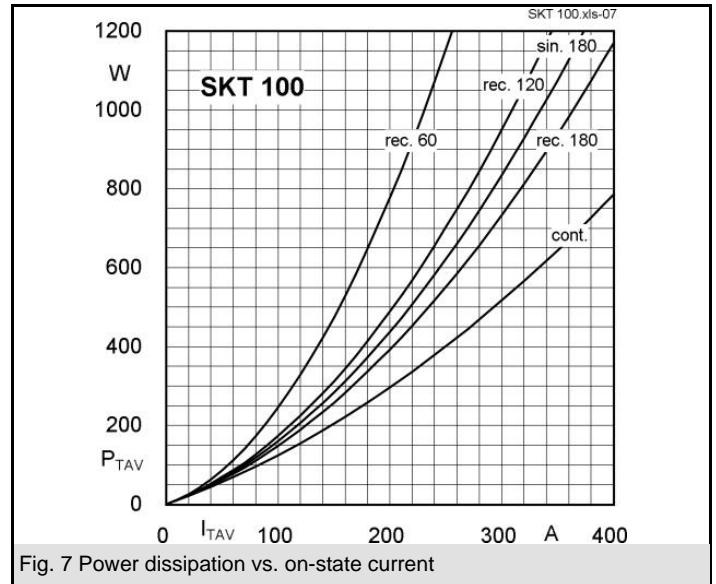
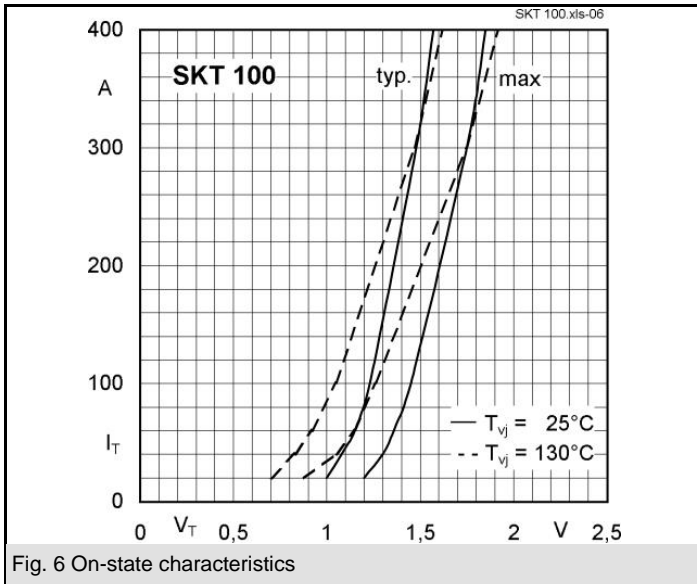
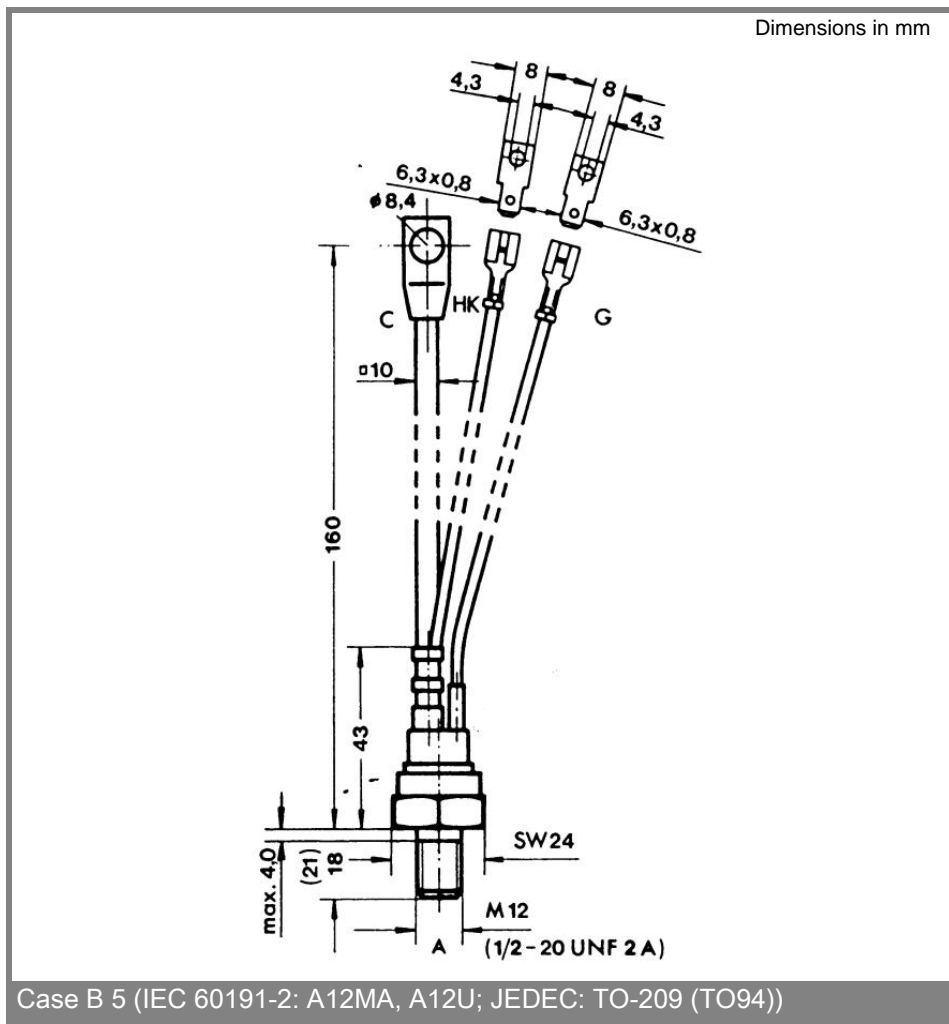
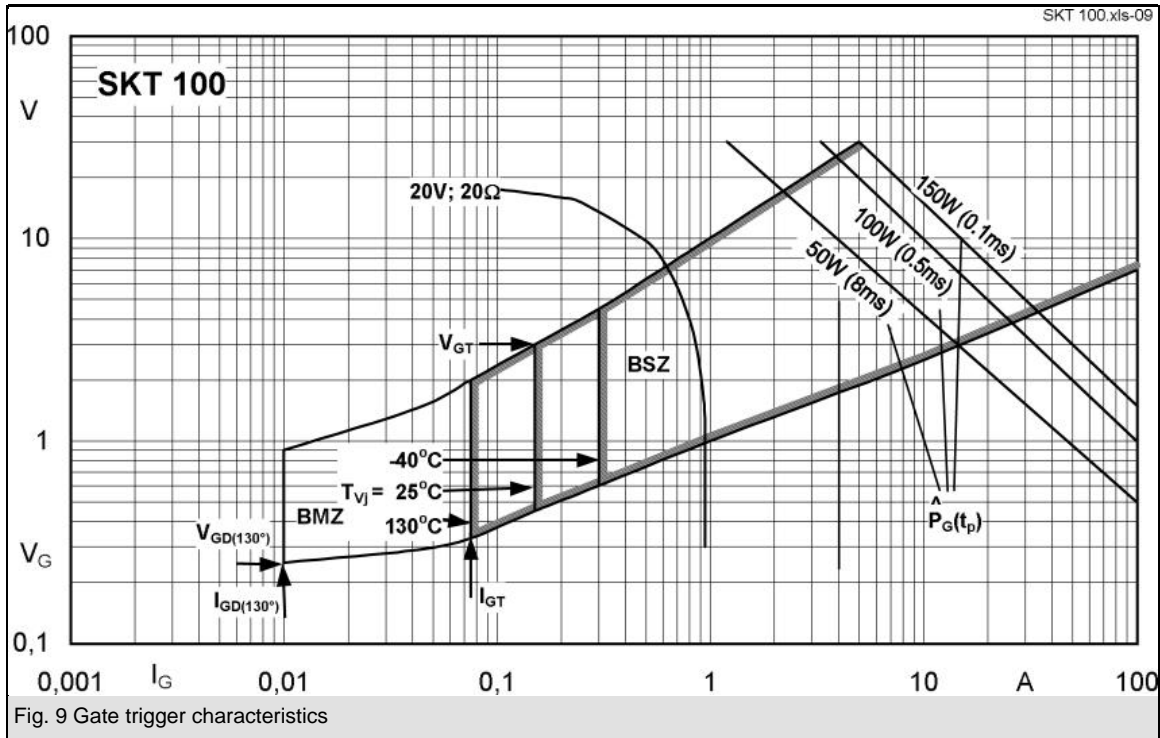

Fig. 5 Thermal resistance vs. conduction angle





* The specifications of our components may not be considered as an assurance of component characteristics. Components have to be tested for the respective application. Adjustments may be necessary. The use of SEMIKRON

products in life support appliances and systems is subject to prior specification and written approval by SEMIKRON. We therefore strongly recommend prior consultation of our personal.