

# DATA SHEET

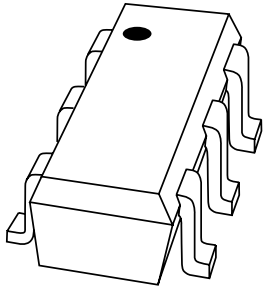

## **BF1204** Dual N-channel dual gate MOS-FET

Product specification  
Supersedes data of 2000 Nov 13

2001 Apr 25

# Dual N-channel dual gate MOS-FET

BF1204

## FEATURES

- Two low noise gain controlled amplifiers in a single package
- Superior cross-modulation performance during AGC
- High forward transfer admittance
- High forward transfer admittance to input capacitance ratio.

## APPLICATIONS

- Gain controlled low noise amplifiers for VHF and UHF applications with 3 to 9 V supply voltage, such as digital and analog television tuners and professional communications equipment.

## DESCRIPTION

The BF1204 is a combination of two equal dual gate MOS-FET amplifiers with shared source and gate 2 leads. The source and substrate are interconnected. Internal bias circuits enable DC stabilization and a very good cross-modulation performance during AGC. Integrated diodes between the gates and source protect against excessive input voltage surges. The transistor has a SOT363 micro-miniature plastic package.

## PINNING - SOT363

PIN	DESCRIPTION
1	gate 1 (a)
2	gate 2
3	gate 1 (b)
4	drain (b)
5	source
6	drain (a)

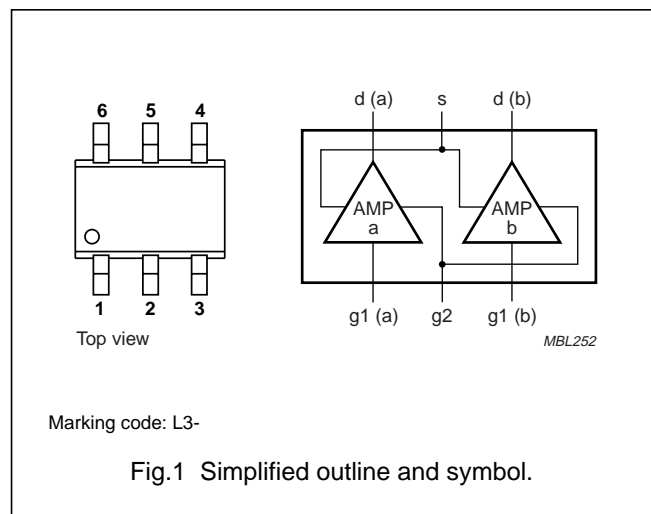

## QUICK REFERENCE DATA

SYMBOL	PARAMETER	CONDITIONS	MIN.	TYP.	MAX.	UNIT
<b>Per MOS-FET; unless otherwise specified</b>						
$V_{DS}$	drain-source voltage		–	–	10	V
$I_D$	drain current (DC)		–	–	30	mA
$P_{tot}$	total power dissipation	$T_s \leq 102\text{ }^\circ\text{C}$ ; note 1	–	–	200	mW
$ y_{fs} $	forward transfer admittance	$I_D = 12\text{ mA}$ ; $f = 1\text{ MHz}$	25	30	40	mS
$C_{ig1-s}$	input capacitance at gate 1	$I_D = 12\text{ mA}$ ; $f = 1\text{ MHz}$	–	1.7	2.2	pF
$C_{rss}$	reverse transfer capacitance	$f = 1\text{ MHz}$	–	15	–	fF
NF	noise figure	$f = 800\text{ MHz}$	–	1.1	1.8	dB
$X_{mod}$	cross-modulation	input level for $k = 1\%$ at 40 dB AGC	100	105	–	dB $\mu$ V
$T_j$	operating junction temperature		–	–	150	$^\circ\text{C}$

## Note

1.  $T_s$  is the temperature at the soldering point of the source lead.

## CAUTION

This product is supplied in anti-static packing to prevent damage caused by electrostatic discharge during transport and handling. For further information, refer to Philips specs.: SNW-EQ-608, SNW-FQ-302A and SNW-FQ-302B.

# Dual N-channel dual gate MOS-FET

BF1204

## LIMITING VALUES

In accordance with the Absolute Maximum Rating System (IEC 60134).

SYMBOL	PARAMETER	CONDITIONS	MIN.	MAX.	UNIT
<b>Per MOS-FET; unless otherwise specified</b>					
V <sub>DS</sub>	drain-source voltage		–	10	V
I <sub>D</sub>	drain current (DC)		–	30	mA
I <sub>G1</sub>	gate 1 current		–	±10	mA
I <sub>G2</sub>	gate 2 current		–	±10	mA
P <sub>tot</sub>	total power dissipation	T <sub>s</sub> ≤ 102 °C	–	200	mW
T <sub>stg</sub>	storage temperature		–65	+150	°C
T <sub>j</sub>	operating junction temperature		–	150	°C

## THERMAL CHARACTERISTICS

SYMBOL	PARAMETER	VALUE	UNIT
R <sub>th j-s</sub>	thermal resistance from junction to soldering point	240	K/W

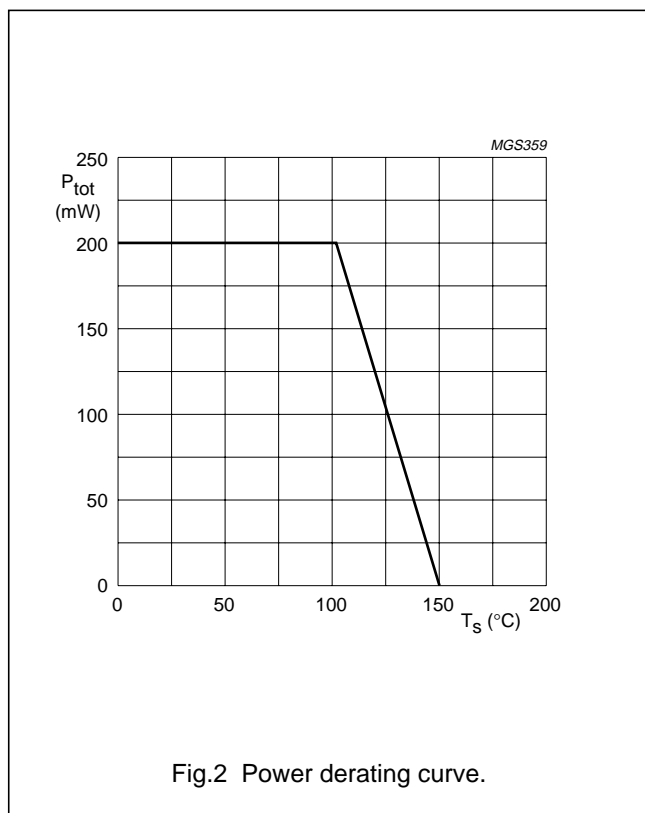

## Dual N-channel dual gate MOS-FET

BF1204

## STATIC CHARACTERISTICS

 $T_j = 25\text{ °C}$ ; per MOS-FET; unless otherwise specified.

SYMBOL	PARAMETER	CONDITIONS	MIN.	MAX.	UNIT
$V_{(BR)DSS}$	drain-source breakdown voltage	$V_{G1-S} = V_{G2-S} = 0$ ; $I_D = 10\text{ }\mu\text{A}$	10	–	V
$V_{(BR)G1-SS}$	gate-source breakdown voltage	$V_{GS} = V_{DS} = 0$ ; $I_{G1-S} = 10\text{ mA}$	6	10	V
$V_{(BR)G2-SS}$	gate-source breakdown voltage	$V_{GS} = V_{DS} = 0$ ; $I_{G2-S} = 10\text{ mA}$	6	10	V
$V_{(F)S-G1}$	forward source-gate voltage	$V_{G2-S} = V_{DS} = 0$ ; $I_{S-G1} = 10\text{ mA}$	0.5	1.5	V
$V_{(F)S-G2}$	forward source-gate voltage	$V_{G1-S} = V_{DS} = 0$ ; $I_{S-G2} = 10\text{ mA}$	0.5	1.5	V
$V_{G1-S(th)}$	gate-source threshold voltage	$V_{DS} = 5\text{ V}$ ; $V_{G2-S} = 4\text{ V}$ ; $I_D = 100\text{ }\mu\text{A}$	0.3	1	V
$V_{G2-S(th)}$	gate-source threshold voltage	$V_{DS} = 5\text{ V}$ ; $V_{G1-S} = 4\text{ V}$ ; $I_D = 100\text{ }\mu\text{A}$	0.3	1.2	V
$I_{DSX}$	drain-source current	$V_{G2-S} = 4\text{ V}$ ; $V_{DS} = 5\text{ V}$ ; $R_G = 120\text{ k}\Omega$ ; note 1	8	16	mA
$I_{G1-S}$	gate cut-off current	$V_{G1-S} = 5\text{ V}$ ; $V_{G2-S} = V_{DS} = 0$	–	50	nA
$I_{G2-S}$	gate cut-off current	$V_{G2-S} = 4\text{ V}$ ; $V_{G1-S} = V_{DS} = 0$	–	20	nA

## Note

- $R_{G1}$  connects gate 1 to  $V_{GG} = 5\text{ V}$ .

## DYNAMIC CHARACTERISTICS

Common source;  $T_{amb} = 25\text{ °C}$ ;  $V_{G2-S} = 4\text{ V}$ ;  $V_{DS} = 5\text{ V}$ ;  $I_D = 12\text{ mA}$ ; per MOS-FET <sup>(1)</sup>; unless otherwise specified.

SYMBOL	PARAMETER	CONDITIONS	MIN.	TYP.	MAX.	UNIT
$ y_{fs} $	forward transfer admittance	$T_j = 25\text{ °C}$	25	30	40	mS
$C_{ig1-ss}$	input capacitance at gate 1	$f = 1\text{ MHz}$	–	1.7	2.2	pF
$C_{ig2-ss}$	input capacitance at gate 2	$f = 1\text{ MHz}$	–	3.3	–	pF
$C_{oss}$	output capacitance	$f = 1\text{ MHz}$	–	0.85	–	pF
$C_{rss}$	reverse transfer capacitance	$f = 1\text{ MHz}$	–	15	–	fF
$G_{tr}$	power gain	$f = 200\text{ MHz}$ ; $G_S = 2\text{ mS}$ ; $B_S = B_{S(opt)}$ ; $G_L = 0.5\text{ mS}$ ; $B_L = B_{L(opt)}$ ; note 1	30	34	38	dB
		$f = 400\text{ MHz}$ ; $G_S = 2\text{ mS}$ ; $B_S = B_{S(opt)}$ ; $G_L = 1\text{ mS}$ ; $B_L = B_{L(opt)}$ ; note 1	26	30	34	dB
		$f = 800\text{ MHz}$ ; $G_S = 3.3\text{ mS}$ ; $B_S = B_{S(opt)}$ ; $G_L = 1\text{ mS}$ ; $B_L = B_{L(opt)}$ ; note 1	21	25	29	dB
NF	noise figure	$f = 10.7\text{ MHz}$ ; $G_S = 20\text{ mS}$ ; $B_S = 0$	–	9	11	dB
		$f = 400\text{ MHz}$ ; $Y_S = Y_{S(opt)}$	–	0.9	1.5	dB
		$f = 800\text{ MHz}$ ; $Y_S = Y_{S(opt)}$	–	1.1	1.8	dB
$X_{mod}$	cross-modulation	input level for $k = 1\%$ at 0 dB AGC; $f_w = 50\text{ MHz}$ ; $f_{unw} = 60\text{ MHz}$ ; note 2	90	–	–	dB $\mu$ V
		input level for $k = 1\%$ at 10 dB AGC; $f_w = 50\text{ MHz}$ ; $f_{unw} = 60\text{ MHz}$ ; note 2	–	92	–	dB $\mu$ V
		input level for $k = 1\%$ at 40 dB AGC; $f_w = 50\text{ MHz}$ ; $f_{unw} = 60\text{ MHz}$ ; note 2	100	105	–	dB $\mu$ V

## Notes

- For the MOS-FET not in use:  $V_{G1-S} = 0$ ;  $V_{DS} = 0$ .
- Measured in Fig.19 test circuit.

Dual N-channel dual gate MOS-FET

BF1204

ALL GRAPHS FOR ONE MOS-FET

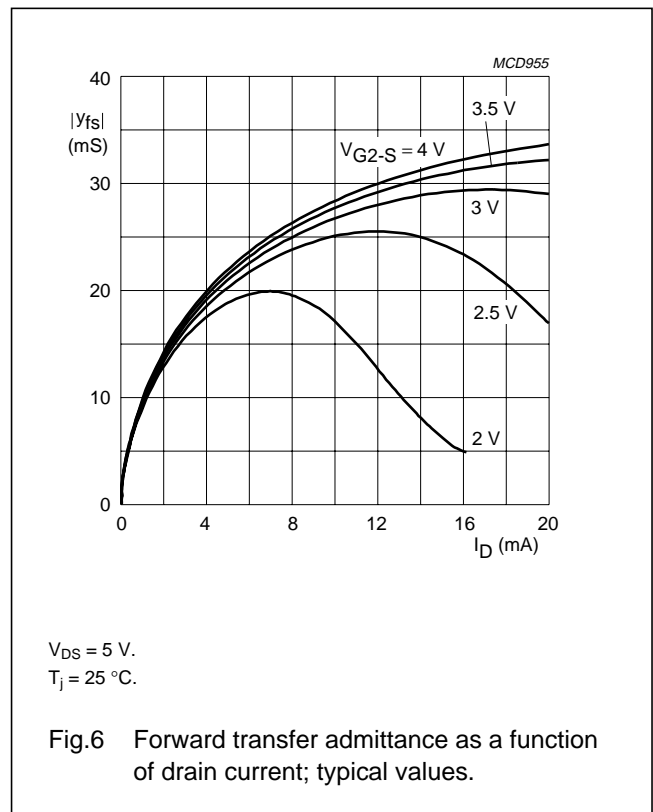
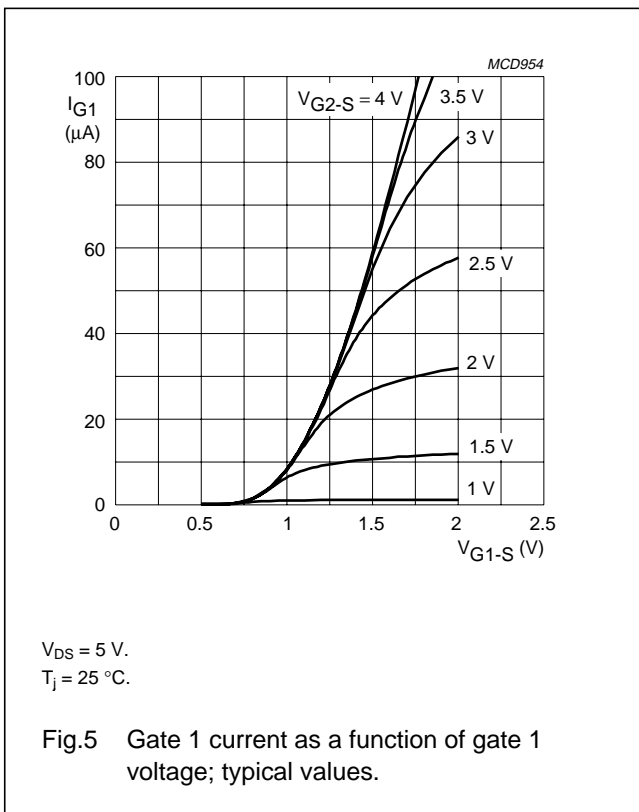
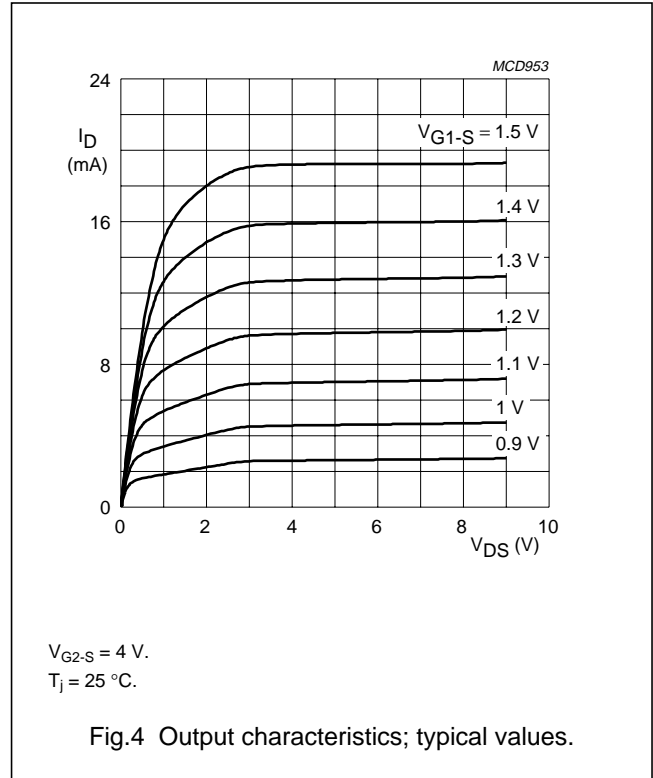
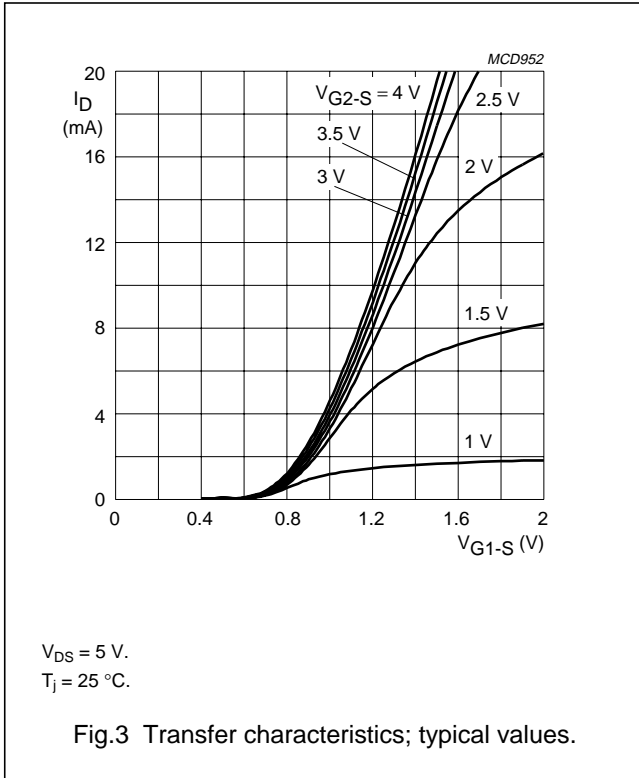

Dual N-channel dual gate MOS-FET

BF1204

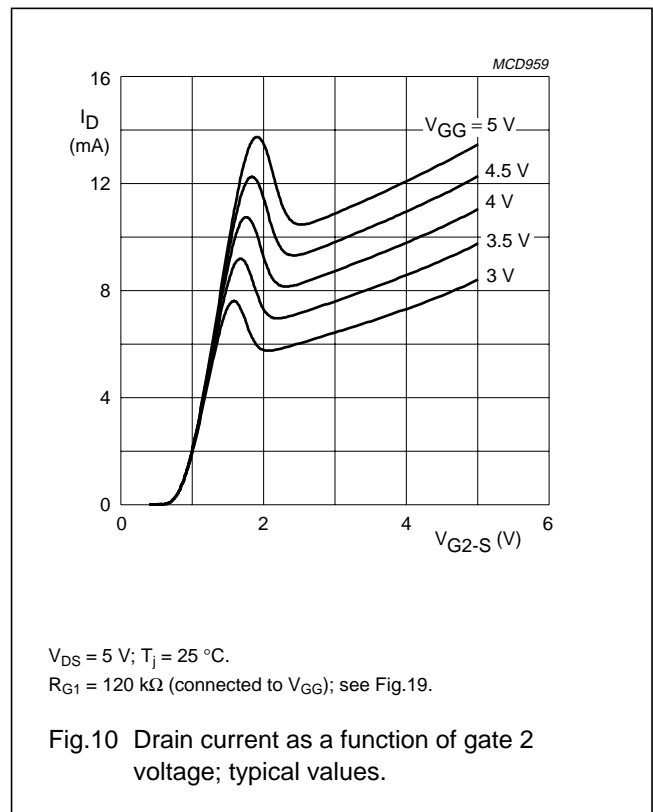
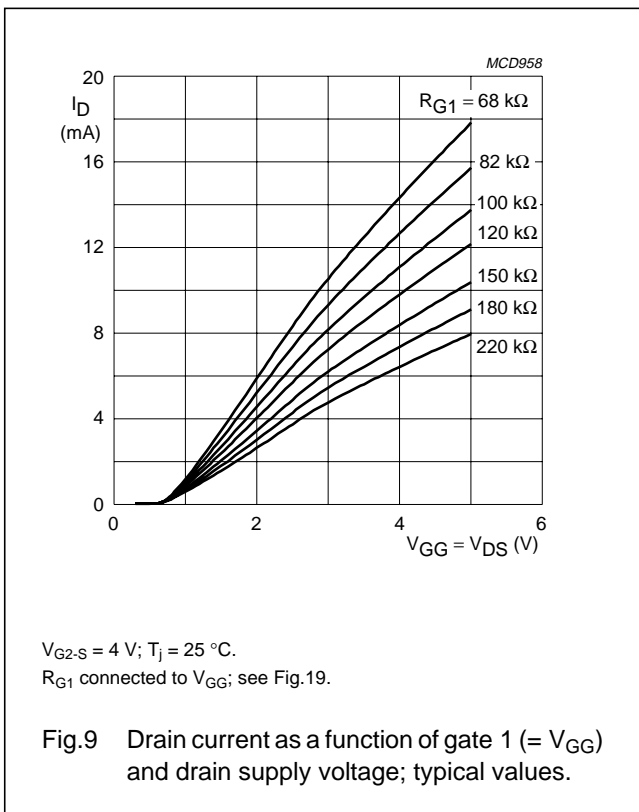
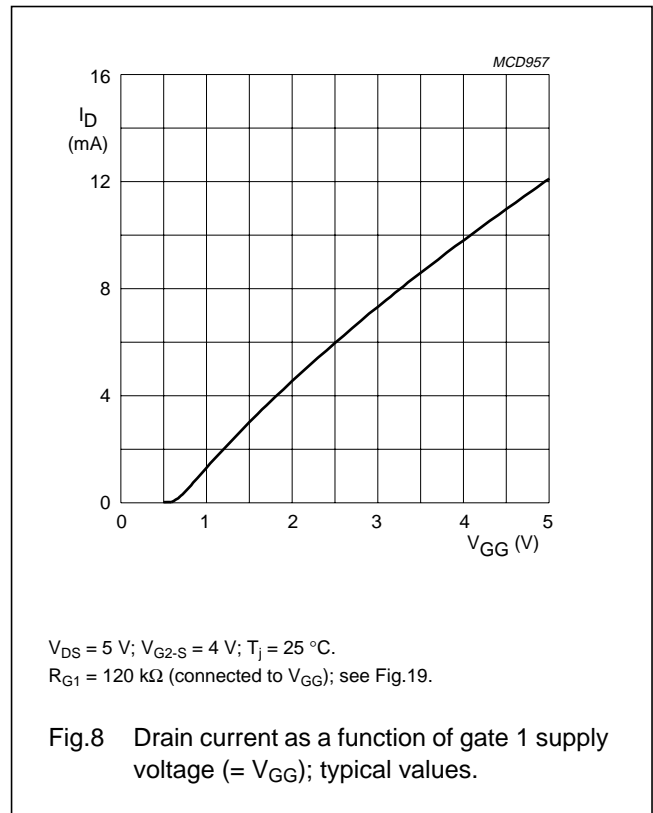
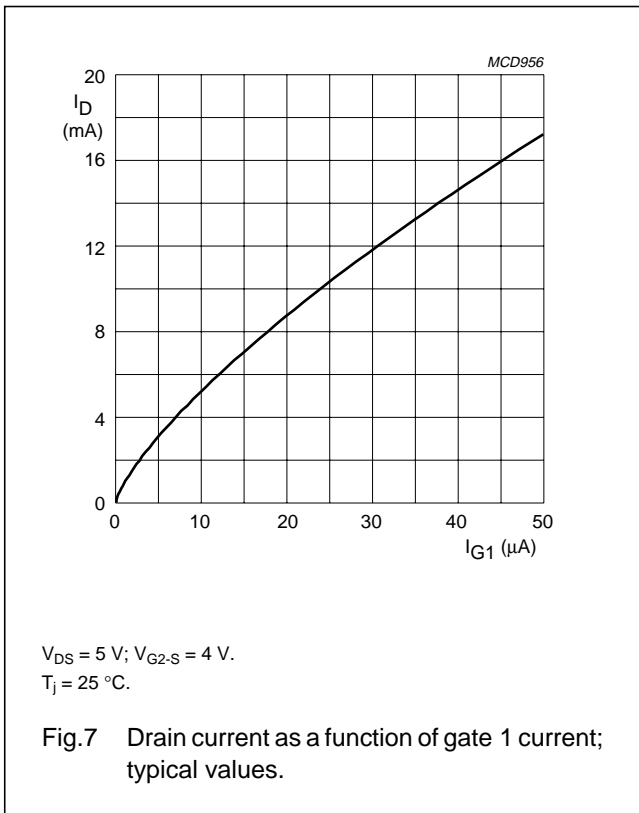

Dual N-channel dual gate MOS-FET

BF1204

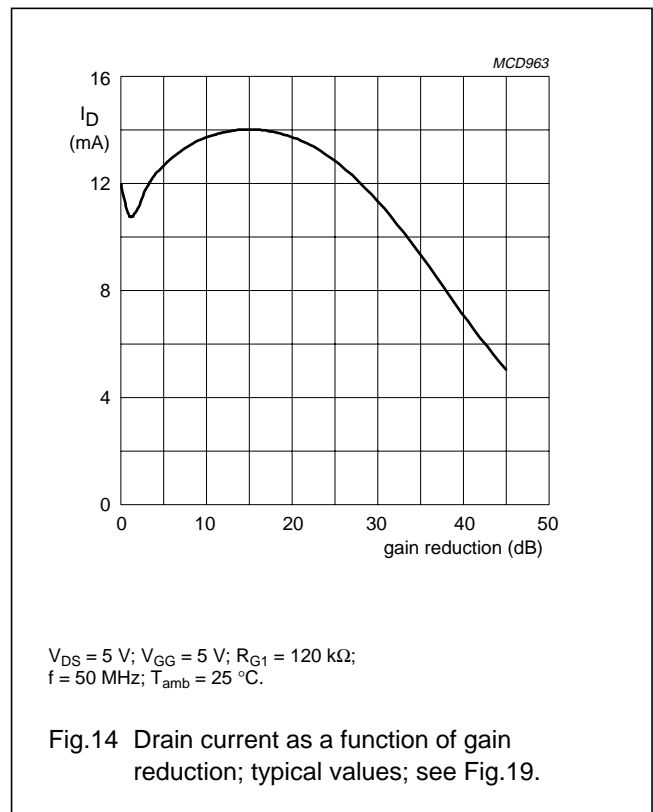
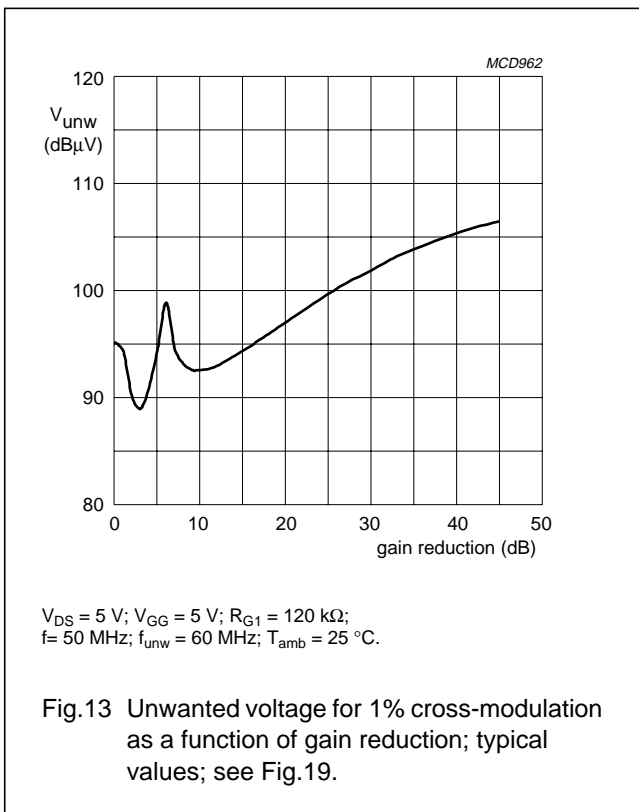
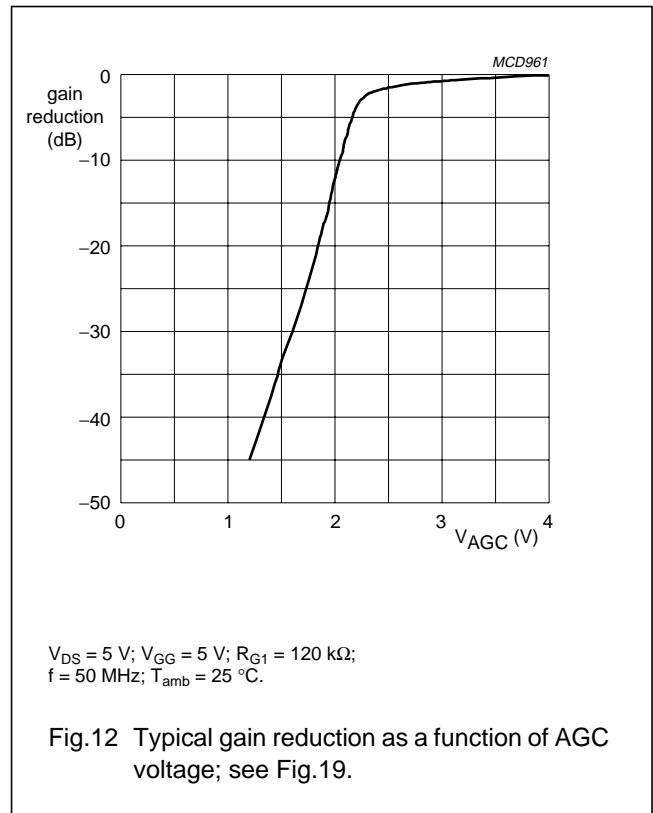
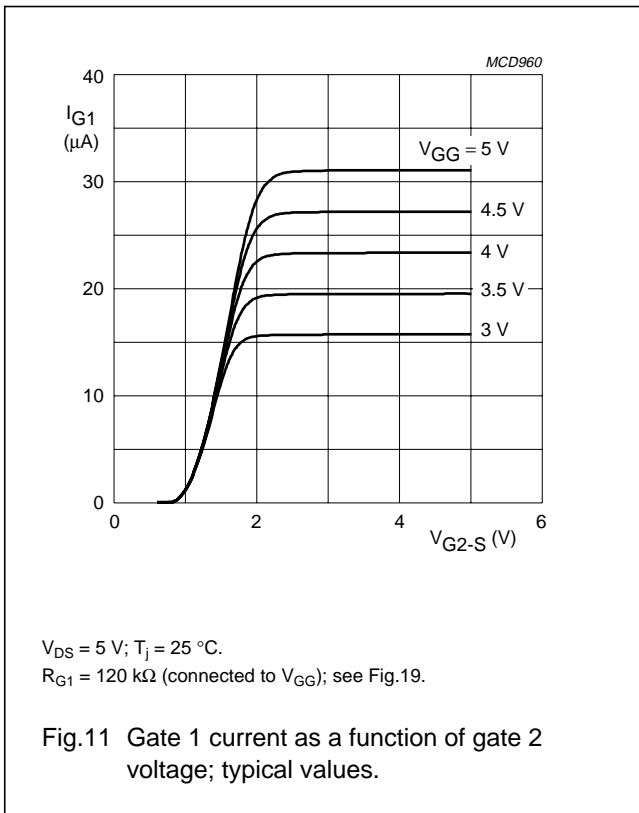

Dual N-channel dual gate MOS-FET

BF1204

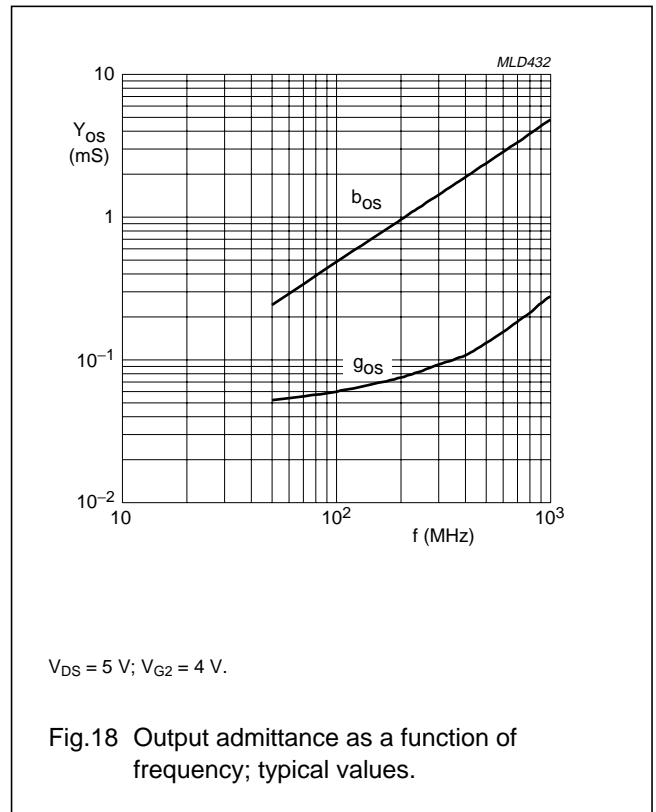
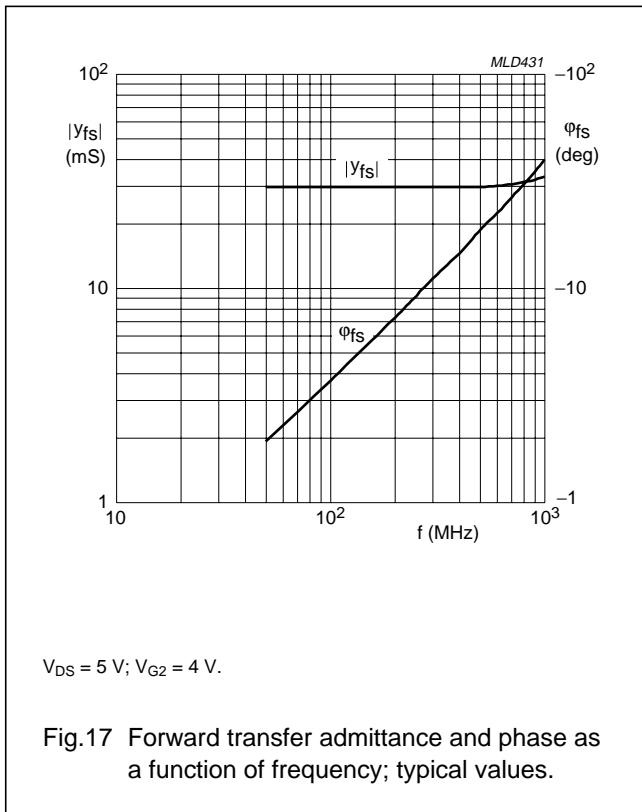
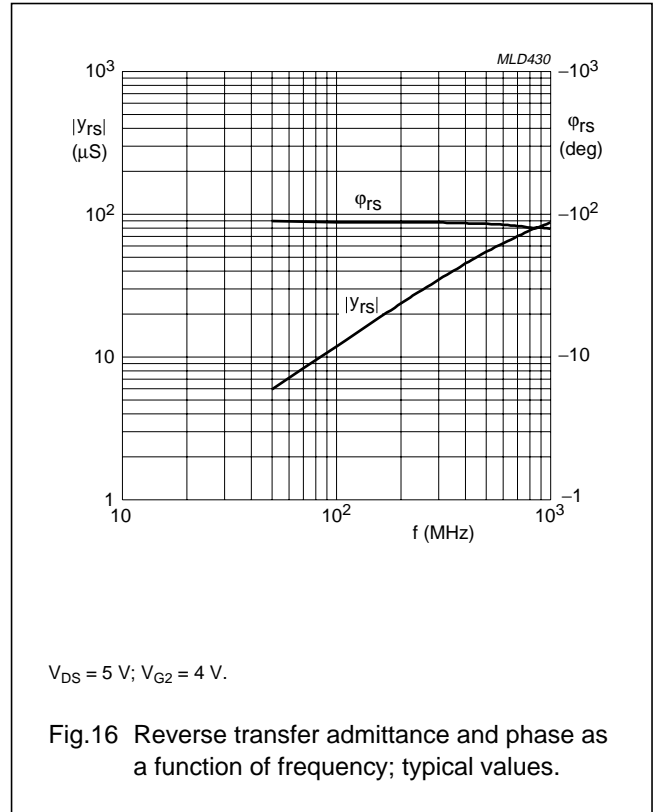
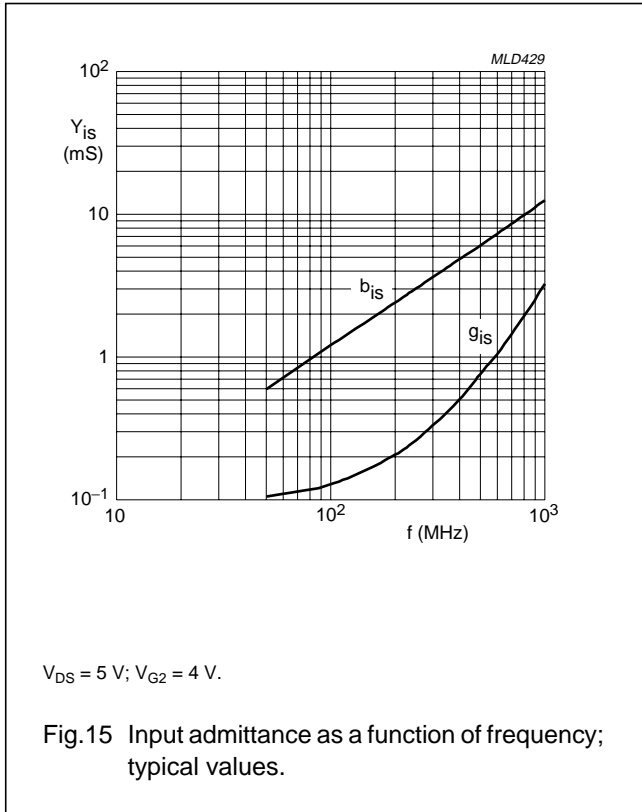

Dual N-channel dual gate MOS-FET

BF1204

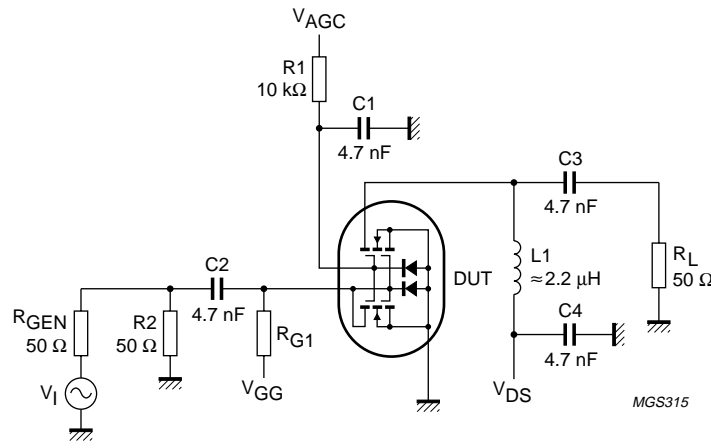

Fig.19 Cross-modulation test set-up (for one MOS-FET).

Scattering parameters

$V_{DS} = 5\text{ V}$ ;  $V_{G2-S} = 4\text{ V}$ ;  $I_D = 12\text{ mA}$ ;  $T_{amb} = 25\text{ }^\circ\text{C}$ .

f (MHz)	S <sub>11</sub>		S <sub>21</sub>		S <sub>12</sub>		S <sub>22</sub>	
	MAGNITUDE (ratio)	ANGLE (deg)	MAGNITUDE (ratio)	ANGLE (deg)	MAGNITUDE (ratio)	ANGLE (deg)	MAGNITUDE (ratio)	ANGLE (deg)
50	0.991	-3.29	2.95	175.78	0.00060	85.25	0.995	-1.44
100	0.987	-7.12	2.90	171.61	0.00119	84.74	0.994	-2.90
200	0.981	-14.21	2.86	163.45	0.00234	80.85	0.992	-5.70
300	0.969	-21.22	2.83	155.11	0.00339	75.77	0.989	-8.50
400	0.958	-28.14	2.79	147.37	0.00429	72.23	0.987	-11.25
500	0.939	-35.01	2.74	139.04	0.00508	68.24	0.983	-13.96
600	0.921	-41.75	2.68	131.35	0.00565	64.97	0.981	-16.67
700	0.898	-48.51	2.62	123.38	0.00611	61.90	0.976	-19.36
800	0.874	-54.96	2.55	115.74	0.00646	57.77	0.973	-22.04
900	0.847	-61.62	2.49	107.84	0.00662	55.04	0.969	-24.80
1000	0.817	-67.84	2.41	100.24	0.00670	52.16	0.966	-27.45

# Dual N-channel dual gate MOS-FET

BF1204

## PACKAGE OUTLINE

Plastic surface mounted package; 6 leads

SOT363

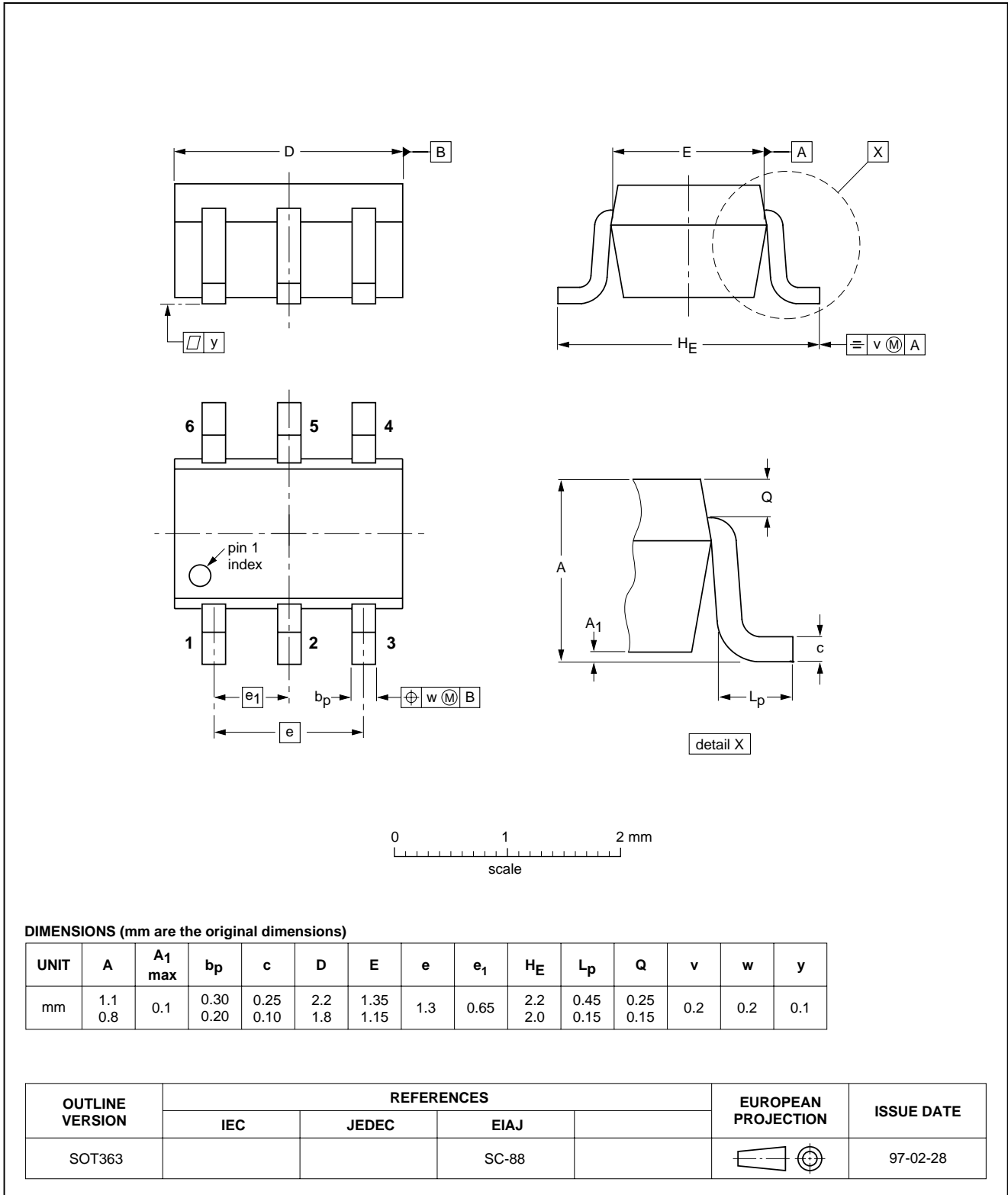

## Dual N-channel dual gate MOS-FET

BF1204

## DATA SHEET STATUS

DATA SHEET STATUS <sup>(1)</sup>	PRODUCT STATUS <sup>(2)</sup>	DEFINITIONS
Objective data	Development	This data sheet contains data from the objective specification for product development. Philips Semiconductors reserves the right to change the specification in any manner without notice.
Preliminary data	Qualification	This data sheet contains data from the preliminary specification. Supplementary data will be published at a later date. Philips Semiconductors reserves the right to change the specification without notice, in order to improve the design and supply the best possible product.
Product data	Production	This data sheet contains data from the product specification. Philips Semiconductors reserves the right to make changes at any time in order to improve the design, manufacturing and supply. Changes will be communicated according to the Customer Product/Process Change Notification (CPCN) procedure SNW-SQ-650A.

## Notes

1. Please consult the most recently issued data sheet before initiating or completing a design.
2. The product status of the device(s) described in this data sheet may have changed since this data sheet was published. The latest information is available on the Internet at URL <http://www.semiconductors.philips.com>.

## DEFINITIONS

**Short-form specification** — The data in a short-form specification is extracted from a full data sheet with the same type number and title. For detailed information see the relevant data sheet or data handbook.

**Limiting values definition** — Limiting values given are in accordance with the Absolute Maximum Rating System (IEC 60134). Stress above one or more of the limiting values may cause permanent damage to the device. These are stress ratings only and operation of the device at these or at any other conditions above those given in the Characteristics sections of the specification is not implied. Exposure to limiting values for extended periods may affect device reliability.

**Application information** — Applications that are described herein for any of these products are for illustrative purposes only. Philips Semiconductors make no representation or warranty that such applications will be suitable for the specified use without further testing or modification.

## DISCLAIMERS

**Life support applications** — These products are not designed for use in life support appliances, devices, or systems where malfunction of these products can reasonably be expected to result in personal injury. Philips Semiconductors customers using or selling these products for use in such applications do so at their own risk and agree to fully indemnify Philips Semiconductors for any damages resulting from such application.

**Right to make changes** — Philips Semiconductors reserves the right to make changes, without notice, in the products, including circuits, standard cells, and/or software, described or contained herein in order to improve design and/or performance. Philips Semiconductors assumes no responsibility or liability for the use of any of these products, conveys no licence or title under any patent, copyright, or mask work right to these products, and makes no representations or warranties that these products are free from patent, copyright, or mask work right infringement, unless otherwise specified.

# Philips Semiconductors – a worldwide company

**Argentina:** see South America

**Australia:** 3 Figtree Drive, HOMEBUSH, NSW 2140,  
Tel. +61 2 9704 8141, Fax. +61 2 9704 8139

**Austria:** Computerstr. 6, A-1101 WIEN, P.O. Box 213,  
Tel. +43 1 60 101 1248, Fax. +43 1 60 101 1210

**Belarus:** Hotel Minsk Business Center, Bld. 3, r. 1211, Volodarski Str. 6,  
220050 MINSK, Tel. +375 172 20 0733, Fax. +375 172 20 0773

**Belgium:** see The Netherlands

**Brazil:** see South America

**Bulgaria:** Philips Bulgaria Ltd., Energoproject, 15th floor,  
51 James Bourchier Blvd., 1407 SOFIA,  
Tel. +359 2 68 9211, Fax. +359 2 68 9102

**Canada:** PHILIPS SEMICONDUCTORS/COMPONENTS,  
Tel. +1 800 234 7381, Fax. +1 800 943 0087

**China/Hong Kong:** 501 Hong Kong Industrial Technology Centre,  
72 Tat Chee Avenue, Kowloon Tong, HONG KONG,  
Tel. +852 2319 7888, Fax. +852 2319 7700

**Colombia:** see South America

**Czech Republic:** see Austria

**Denmark:** Sydhavnsgade 23, 1780 COPENHAGEN V,  
Tel. +45 33 29 3333, Fax. +45 33 29 3905

**Finland:** Sinikalliontie 3, FIN-02630 ESPOO,  
Tel. +358 9 615 800, Fax. +358 9 6158 0920

**France:** 7 - 9 Rue du Mont Valérien, BP317, 92156 SURESNES Cedex,  
Tel. +33 1 4728 6600, Fax. +33 1 4728 6638

**Germany:** Hammerbrookstraße 69, D-20097 HAMBURG,  
Tel. +49 40 2353 60, Fax. +49 40 2353 6300

**Hungary:** Philips Hungary Ltd., H-1119 Budapest, Fehervari ut 84/A,  
Tel: +36 1 382 1700, Fax: +36 1 382 1800

**India:** Philips INDIA Ltd, Band Box Building, 2nd floor,  
254-D, Dr. Annie Besant Road, Worli, MUMBAI 400 025,  
Tel. +91 22 493 8541, Fax. +91 22 493 0966

**Indonesia:** PT Philips Development Corporation, Semiconductors Division,  
Gedung Philips, Jl. Buncit Raya Kav.99-100, JAKARTA 12510,  
Tel. +62 21 794 0040 ext. 2501, Fax. +62 21 794 0080

**Ireland:** Newstead, Clonskeagh, DUBLIN 14,  
Tel. +353 1 7640 000, Fax. +353 1 7640 200

**Israel:** RAPAC Electronics, 7 Kehilat Saloniki St, PO Box 18053,  
TEL AVIV 61180, Tel. +972 3 645 0444, Fax. +972 3 649 1007

**Italy:** PHILIPS SEMICONDUCTORS, Via Casati, 23 - 20052 MONZA (MI),  
Tel. +39 039 203 6838, Fax +39 039 203 6800

**Japan:** Philips Bldg 13-37, Kohnan 2-chome, Minato-ku,  
TOKYO 108-8507, Tel. +81 3 3740 5130, Fax. +81 3 3740 5057

**Korea:** Philips House, 260-199 Itaewon-dong, Yongsan-ku, SEOUL,  
Tel. +82 2 709 1412, Fax. +82 2 709 1415

**Malaysia:** No. 76 Jalan Universiti, 46200 PETALING JAYA, SELANGOR,  
Tel. +60 3 750 5214, Fax. +60 3 757 4880

**Mexico:** 5900 Gateway East, Suite 200, EL PASO, TEXAS 79905,  
Tel. +9-5 800 234 7381, Fax +9-5 800 943 0087

**Middle East:** see Italy

**Netherlands:** Postbus 90050, 5600 PB EINDHOVEN, Bldg. VB,  
Tel. +31 40 27 82785, Fax. +31 40 27 88399

**New Zealand:** 2 Wagener Place, C.P.O. Box 1041, AUCKLAND,  
Tel. +64 9 849 4160, Fax. +64 9 849 7811

**Norway:** Box 1, Manglerud 0612, OSLO,  
Tel. +47 22 74 8000, Fax. +47 22 74 8341

**Pakistan:** see Singapore

**Philippines:** Philips Semiconductors Philippines Inc.,  
106 Valero St. Salcedo Village, P.O. Box 2108 MCC, MAKATI,  
Metro MANILA, Tel. +63 2 816 6380, Fax. +63 2 817 3474

**Poland:** Al.Jerozolimskie 195 B, 02-222 WARSAW,  
Tel. +48 22 5710 000, Fax. +48 22 5710 001

**Portugal:** see Spain

**Romania:** see Italy

**Russia:** Philips Russia, Ul. Usatcheva 35A, 119048 MOSCOW,  
Tel. +7 095 755 6918, Fax. +7 095 755 6919

**Singapore:** Lorong 1, Toa Payoh, SINGAPORE 319762,  
Tel. +65 350 2538, Fax. +65 251 6500

**Slovakia:** see Austria

**Slovenia:** see Italy

**South Africa:** S.A. PHILIPS Pty Ltd., 195-215 Main Road Martindale,  
2092 JOHANNESBURG, P.O. Box 58088 Newville 2114,  
Tel. +27 11 471 5401, Fax. +27 11 471 5398

**South America:** Al. Vicente Pinzon, 173, 6th floor,  
04547-130 SÃO PAULO, SP, Brazil,  
Tel. +55 11 821 2333, Fax. +55 11 821 2382

**Spain:** Balmes 22, 08007 BARCELONA,  
Tel. +34 93 301 6312, Fax. +34 93 301 4107

**Sweden:** Kottbygatan 7, Akalla, S-16485 STOCKHOLM,  
Tel. +46 8 5985 2000, Fax. +46 8 5985 2745

**Switzerland:** Allmendstrasse 140, CH-8027 ZÜRICH,  
Tel. +41 1 488 2741 Fax. +41 1 488 3263

**Taiwan:** Philips Semiconductors, 5F, No. 96, Chien Kuo N. Rd., Sec. 1,  
TAIPEI, Taiwan Tel. +886 2 2134 2451, Fax. +886 2 2134 2874

**Thailand:** PHILIPS ELECTRONICS (THAILAND) Ltd.,  
60/14 MOO 11, Bangna Trad Road KM. 3, Bagna, BANGKOK 10260,  
Tel. +66 2 361 7910, Fax. +66 2 398 3447

**Turkey:** Yukari Dudullu, Org. San. Blg., 2.Cad. Nr. 28 81260 Umraniye,  
ISTANBUL, Tel. +90 216 522 1500, Fax. +90 216 522 1813

**Ukraine:** PHILIPS UKRAINE, 4 Patrice Lumumba str., Building B, Floor 7,  
252042 KIEV, Tel. +380 44 264 2776, Fax. +380 44 268 0461

**United Kingdom:** Philips Semiconductors Ltd., 276 Bath Road, Hayes,  
MIDDLESEX UB3 5BX, Tel. +44 208 730 5000, Fax. +44 208 754 8421

**United States:** 811 East Arques Avenue, SUNNYVALE, CA 94088-3409,  
Tel. +1 800 234 7381, Fax. +1 800 943 0087

**Uruguay:** see South America

**Vietnam:** see Singapore

**Yugoslavia:** PHILIPS, Trg N. Pasica 5/v, 11000 BEOGRAD,  
Tel. +381 11 3341 299, Fax.+381 11 3342 553

**For all other countries apply to:** Philips Semiconductors,  
Marketing Communications, Building BE-p, P.O. Box 218, 5600 MD EINDHOVEN,  
The Netherlands, Fax. +31 40 27 24825

**Internet:** <http://www.semiconductors.philips.com>

© Philips Electronics N.V. 2001

SCA 72

All rights are reserved. Reproduction in whole or in part is prohibited without the prior written consent of the copyright owner.

The information presented in this document does not form part of any quotation or contract, is believed to be accurate and reliable and may be changed without notice. No liability will be accepted by the publisher for any consequence of its use. Publication thereof does not convey nor imply any license under patent- or other industrial or intellectual property rights.

Printed in The Netherlands

613512/02/pp12

Date of release: 2001 Apr 25

Document order number: 9397 750 08297

*Let's make things better.*

**Philips**  
Semiconductors



**PHILIPS**