

Reflexlichtschranke mit VCSEL-Sender
Reflective Interrupter with VCSEL-Emitter
Lead (Pb) Free Product - RoHS Compliant

SFH 9210

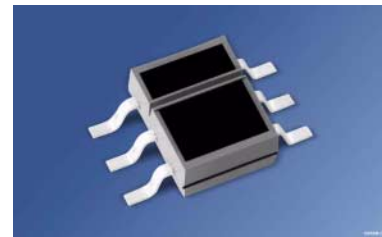

Wesentliche Merkmale

- Großer Arbeitsabstand (2-10mm)
- IR-GaAs-VCSEL (Vertical Cavity Surface Emitting Laser) in Kombination mit einem Si-NPN-Fototransistor
- Enge Strahlverteilung des Senders
- Tageslichtsperrfilter

Features

- Long operating distance (2-10mm)
- IR-GaAs-VCSEL (Vertical Cavity Surface Emitting Laser) in combination with a Silicon NPN phototransistor
- Narrow beam characteristics of the emitter
- Daylight cut-off filter

Anwendungen

- Positionssensor
- Endabschaltung
- Drehzahlüberwachung, -regelung
- Bewegungssensor

Applications

- Position sensor
- End position switch
- Speed monitoring and regulating
- Motion sensor

Typ Type	Bestellnummer Ordering Code	I_{CE} [mA] ($I_F = 8 \text{ mA}$, $V_{CE} = 5 \text{ V}$, $d = 5 \text{ mm}$) (see note on page 5)
SFH 9210	Q65110A2713	1 8

Beim Betrieb dieses Bauteils sind die Sicherheitsvorschriften für die Laserklasse 1M nach IEC 60825-1 Am. 2 zu beachten.

Operating this device the safety instructions for laser class 1M according to IEC 60825-1 Am. 2 have to be observed.



ATTENTION - Observe Precautions For Handling - Electrostatic Sensitive Device

Grenzwerte
Maximum Ratings

Bezeichnung Parameter	Symbol Symbol	Wert Value	Einheit Unit
--------------------------	------------------	---------------	-----------------

Sender (GaAs-VCSEL-Diode)
Emitter (GaAs VCSEL diode)

Sperrspannung Reverse voltage	V_R	3	V
Vorwärtsgleichstrom Forward current	I_F	10	mA
Verlustleistung Power dissipation	P_{tot}	25	mW

Empfänger (Si-Fototransistor)
Detector (silicon phototransistor)

Dauer-Kollektor-Emitter-Sperrspannung Continuous collector-emitter voltage	V_{CE}	16	V
Kollektor-Emitter-Sperrspannung, ($t \leq 2$ min) Collector-emitter voltage, ($t \leq 2$ min)	V_{CE}	30	
Emitter-Kollektor-Sperrspannung Emitter-collector voltage	V_{EC}	7	
Kollektorstrom Collector current	I_C	20	mA
Verlustleistung Total power dissipation	P_{tot}	100	mW

Reflexlichtschranke
Reflective Interrupter

Lagertemperatur Storage temperature range	T_{stg}	- 40 ... + 85	°C
Betriebstemperatur Operating temperature range	T_{OP}	- 40 ... + 85	
Elektrostatistische Entladung Electrostatic discharge	ESD	400	V
Umweltbedingungen / Environment conditions	3 K3 acc. to EN 60721-3-3 (IEC 721-3-3)		

Kennwerte ($T_A = 25\text{ °C}$)

Characteristics

Bezeichnung Parameter	Symbol Symbol	Wert Value	Einheit Unit
--------------------------	------------------	---------------	-----------------

Sender (GaAs-VCSEL-Diode)

Emitter (GaAs-VCSEL diode)

Wellenlänge der Strahlung Wavelength at peak emission $I_F = 8\text{ mA}$, $t_p = 20\text{ ms}$	λ_{peak}	850	nm
Spektrale Bandbreite bei 50% von I_{max} Spectral bandwidth at 50% of I_{max} $I_F = 8\text{ mA}$	$\Delta\lambda$	1	nm
Schwellenstrom ¹⁾ Threshold current ¹⁾	I_{th}	2.6 (<5)	mA
Durchlaßspannung Forward voltage $I_F = 10\text{ mA}$	V_F	1.8 (≤ 2.3)	V
Sperrstrom Reverse current $V_R = 3\text{ V}$	I_R	0.01 (≤ 1)	μA
Kapazität Capacitance $V_R = 0\text{ V}$, $f = 1\text{ MHz}$	C_O	25	pF
Wärmewiderstand ²⁾ Thermal resistance ²⁾	R_{thJA}	1200	K/W

Empfänger (Si-Fototransistor)

Detector (silicon phototransistor)

Kapazität Capacitance $V_{\text{CE}} = 5\text{ V}$, $f = 1\text{ MHz}$	C_{CE}	10	pF
Kollektor-Emitter-Reststrom Collector-emitter leakage current $V_{\text{CE}} = 20\text{ V}$	I_{CEO}	3 (≤ 200)	nA
Fotostrom (Fremdlichtempfindlichkeit) Photocurrent (outside light density) $V_{\text{CE}} = 5\text{ V}$, $E_V = 1000\text{ Lx}$	I_P	3.5	mA
Wärmewiderstand ²⁾ Thermal resistance ²⁾	R_{thJA}	270	K/W

Kennwerte ($T_A = 25\text{ °C}$)

Characteristics (cont'd)

Bezeichnung Parameter	Symbol Symbol	Wert Value	Einheit Unit
--------------------------	------------------	---------------	-----------------

Reflexlichtschranke Reflective Interrupter

Kollektor-Emitterstrom Collector-emitter current Kodak neutral white test card, 90% Reflexion $I_F = 8\text{ mA}$; $V_{CE} = 5\text{ V}$; $d = 5\text{ mm}$ (see note on page 5)	$I_{CE}^{3)}$ -1 -2 -3 -4	1 ... 8 1 ... 2 1.6 ... 3.2 2.5 ... 5 4 ... 8	mA
Kollektor-Emitter-Sättigungsspannung Collector-emitter-saturation voltage Kodak neutral white test card, 90% Reflexion $I_F = 8\text{ mA}$; $d = 5\text{ mm}$; $I_C = 0.3 \times I_{CE\text{ min.}}$ (see note on page 5)	$V_{CE\text{ sat}}$	0.15 (≤ 0.6)	V

- 1) Der VCSEL emittiert nur bei Flusstströmen größer als I_{th}
VCSEL only emits at forward currents higher than I_{th}
- 2) Montage auf PC-Board mit $> 5\text{ mm}^2$ Padgröße
Mounting on pcb with $> 5\text{ mm}^2$ pad size
- 3) Nur eine Gruppe innerhalb einer Verpackungseinheit. Bezug von Einzelgruppen ist nicht möglich.
Only single group within one packing unit. Single bins can not be ordered.

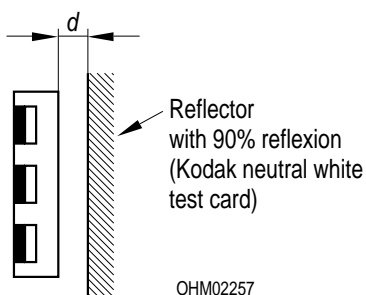

Schaltzeiten ($T_A = 25\text{ °C}$, $V_{CC} = 5\text{ V}$, $I_C = 1\text{ mA}^1$), $R_L = 1\text{ k}\Omega$)

Switching Times

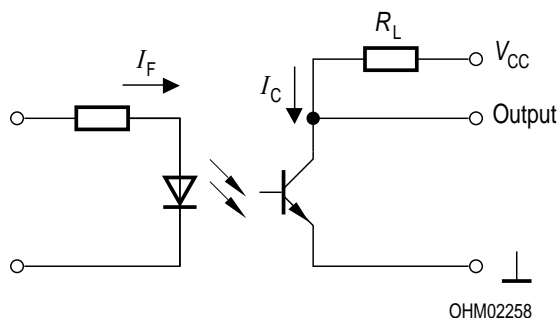

Bezeichnung Parameter	Symbol Symbol	Wert Value	Einheit Unit
Einschaltzeit Turn-on time	t_{ein} t_{on}	65	μs
Anstiegszeit Rise time	t_r	50	μs
Ausschaltzeit Turn-off time	t_{aus} t_{off}	55	μs
Abfallzeit Fall time	t_f	50	μs

¹⁾ I_C eingestellt über den Durchlassstrom der Sendediode, den Reflexionsgrad und den Abstand des Reflektors vom Bauteil (d)

I_C as a function of the forward current of the emitting diode, the degree of reflection and the distance between reflector and component (d)

Anm.:- Es wird empfohlen die Lichtschranke bei dem spezifizierten Arbeitspunkt von ca. 8mA für den Emitter einzusetzen, weil andere Betriebsströme zu einem größeren Streubereich beim Koppelfaktor führen. Der Abgleich erfolgt über den Arbeitswiderstand am Detektor.

Von einem Einsatz der Lichtschranke mit glänzenden oder gar spiegelnden Oberflächen wird abgeraten. Die Abstrahlcharakteristik des Senders ändert sich sowohl über die Temperatur als auch mit dem Flußstrom stärker als bei Standardemittern und führt somit ebenfalls zur Erhöhung des Streubereichs beim Koppelfaktor. Bei diffuser Streuung ist dieser Einfluß jedoch gering, und kann für die meisten Anwendungen vernachlässigt werden.

Note: It is recommended to use the interrupter at the specified emitter current of about 8mA, as other operating currents lead to a larger coupling factor variation. The tuning is done using the operating resistor on the detector side. It is not recommended to use the interrupter in combination with shiny or mirror like surfaces. Changes in temperatures and operating current are having a bigger influence on the radiation characteristic as it is the case for standard emitters. This means a higher variance of the coupling factor. For diffuse surfaces the mentioned influence is low, and can be neglected for most of the applications.

Collector Current $\frac{I_C}{I_{Cmax}} = f(d)$
Kodak 90%

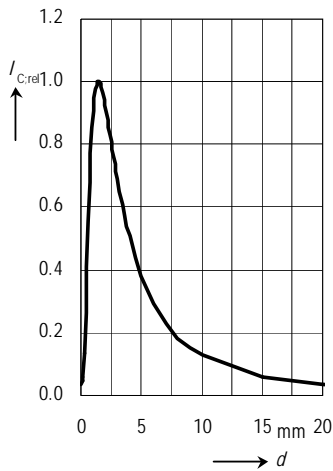

Switching Characteristics $t = f(R_L)$
 $T_A = 25^\circ\text{C}, I_F = 8\text{ mA}$

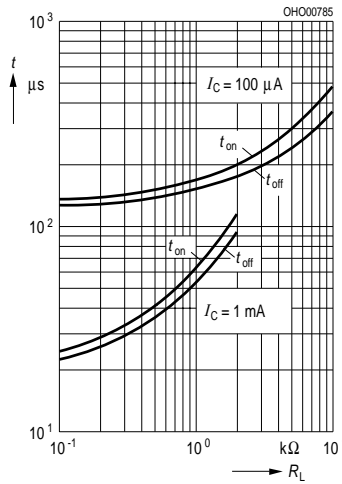

Transistor Capacitance (typ.)
 $C_{CE} = f(V_{CE}), T_A = 25^\circ\text{C}, f = 1\text{ MHz}$

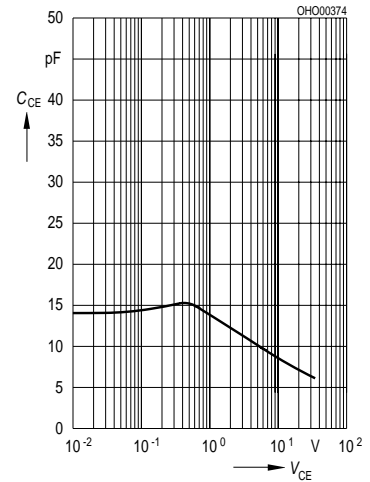

Max. Permissible Forward Current
 $I_F = f(T_A)$

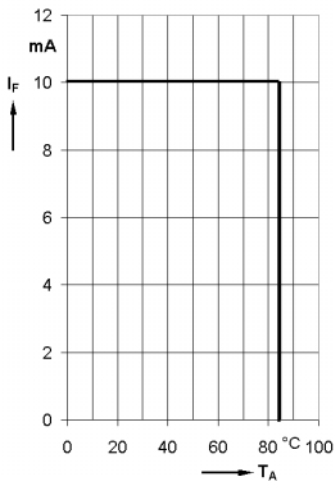

Forward Current
 $I_F = f(V_F)$

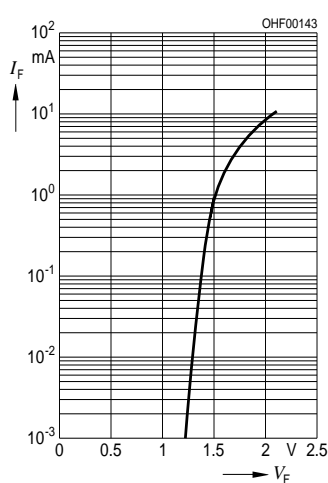

Threshold Current $I_{th} = f(T_A)$

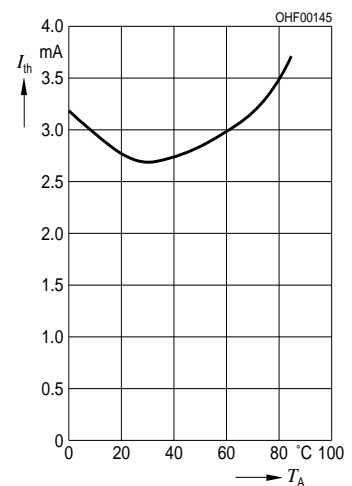

Radiation characteristics $I_{rel} = f(\varphi)$ $I_F = 10\text{ mA}$

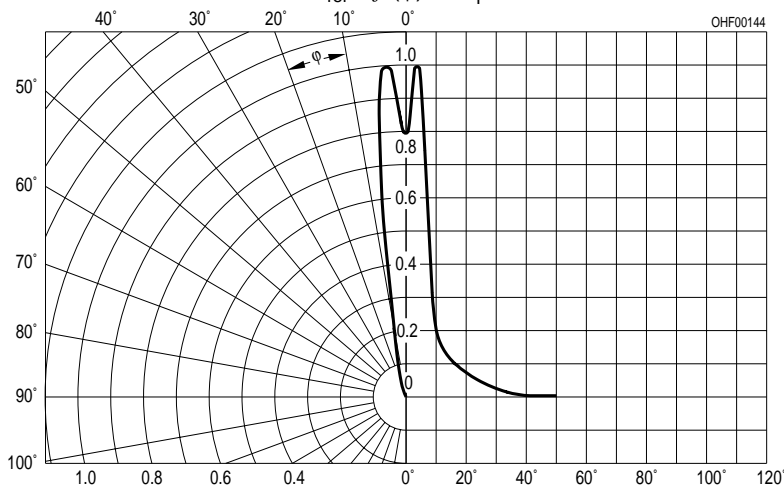

Collector Current $I_C = f(I_F)$
 $d = 5\text{ mm}, \text{Kodak } 90\%$

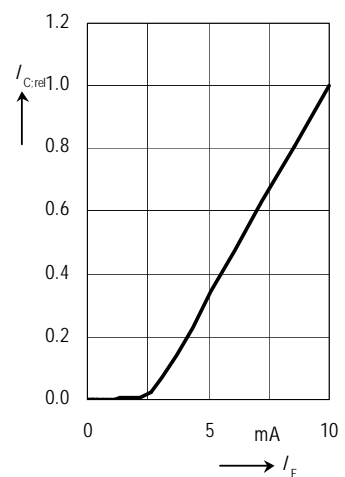

**Maßzeichnung
Package Outlines**

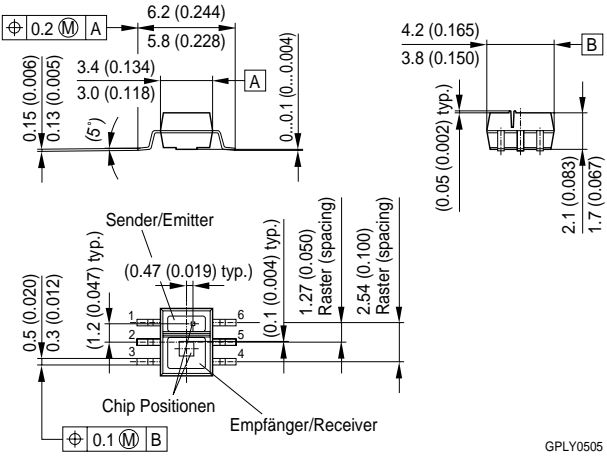

GPLY0505

Type	1	2	3	4	5	6
SFH 9210	Anode	-	Emitter	Collector	-	Cathode

Maße werden wie folgt angegeben: mm (inch) / Dimensions are specified as follows: mm (inch).

Empfohlenes Lötpad Design IR-Reflow Löten
Recommended Solder Pad IR Reflow Soldering

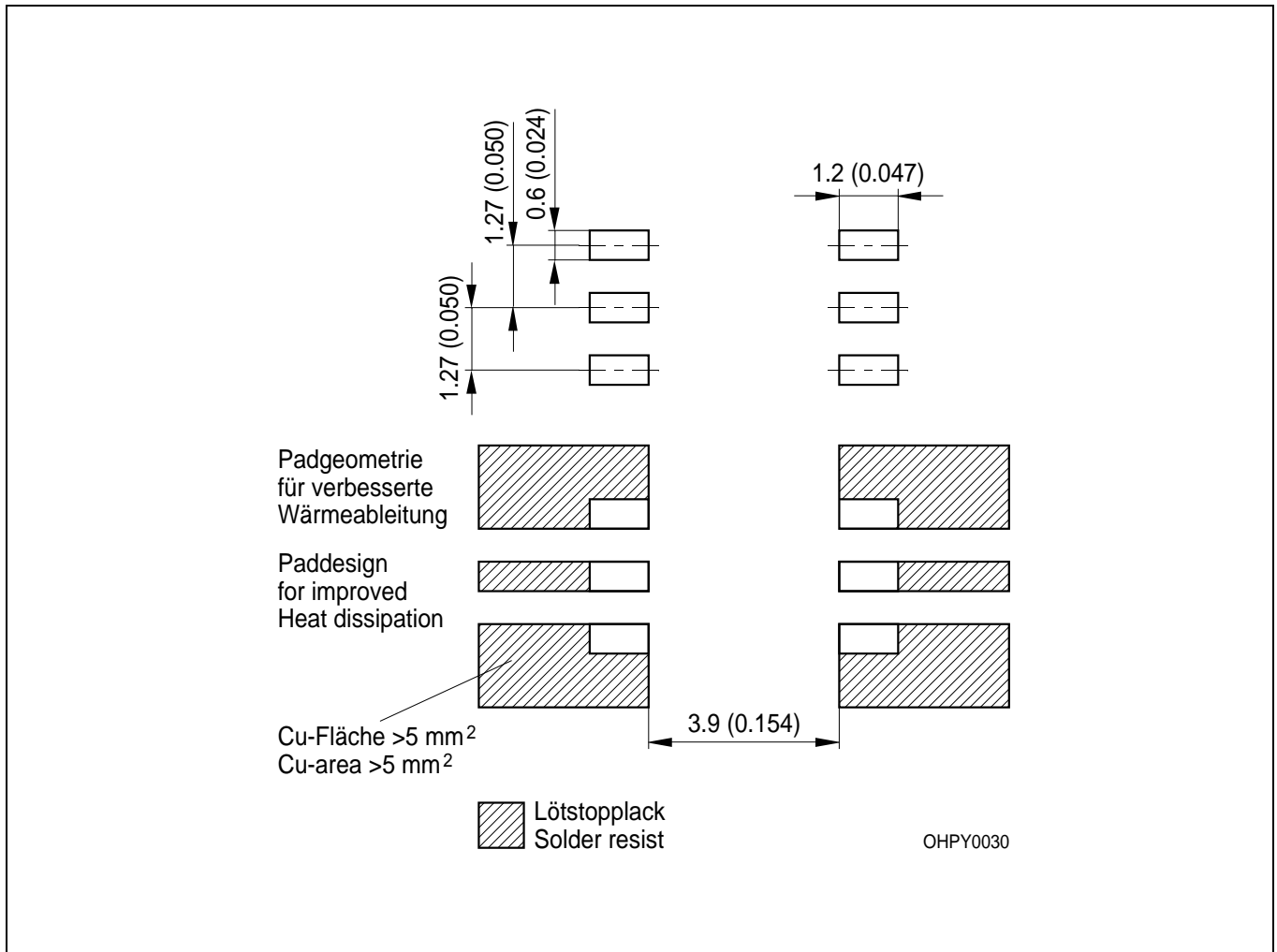

Maße werden wie folgt angegeben: mm (inch) / Dimensions are specified as follows: mm (inch).

**Löthinweise
Soldering Conditions**

Bauform Type	Drypack Level acc. to IPS-stand. 020	Tauch-, Schwallötung Dip, Wave Soldering		Reflowlötung Reflow Soldering		Kolbenlötung Iron Soldering (Iron temp.)
		Peak Temp. (solderbath)	Max. Time in Peak Zone	Peak Temp. (package temp.)	Max. Time in Peak Zone	
SFH 9210	4	n. a.	–	260 °C	20 sec.	n.a.

Bitte Verarbeitungshinweise für SMT-Bauelemente beachten!
Please observe the handling guidelines for SMT devices!

**Lötbedingungen
Soldering Conditions
IR-Reflow Lötprofil für bleifreies Lötén
IR Reflow Soldering Profile for lead free soldering**

Vorbehandlung nach JEDEC Level 4
Preconditioning acc. to JEDEC Level 4 (nach J-STD-020B)
(acc. to J-STD-020B)

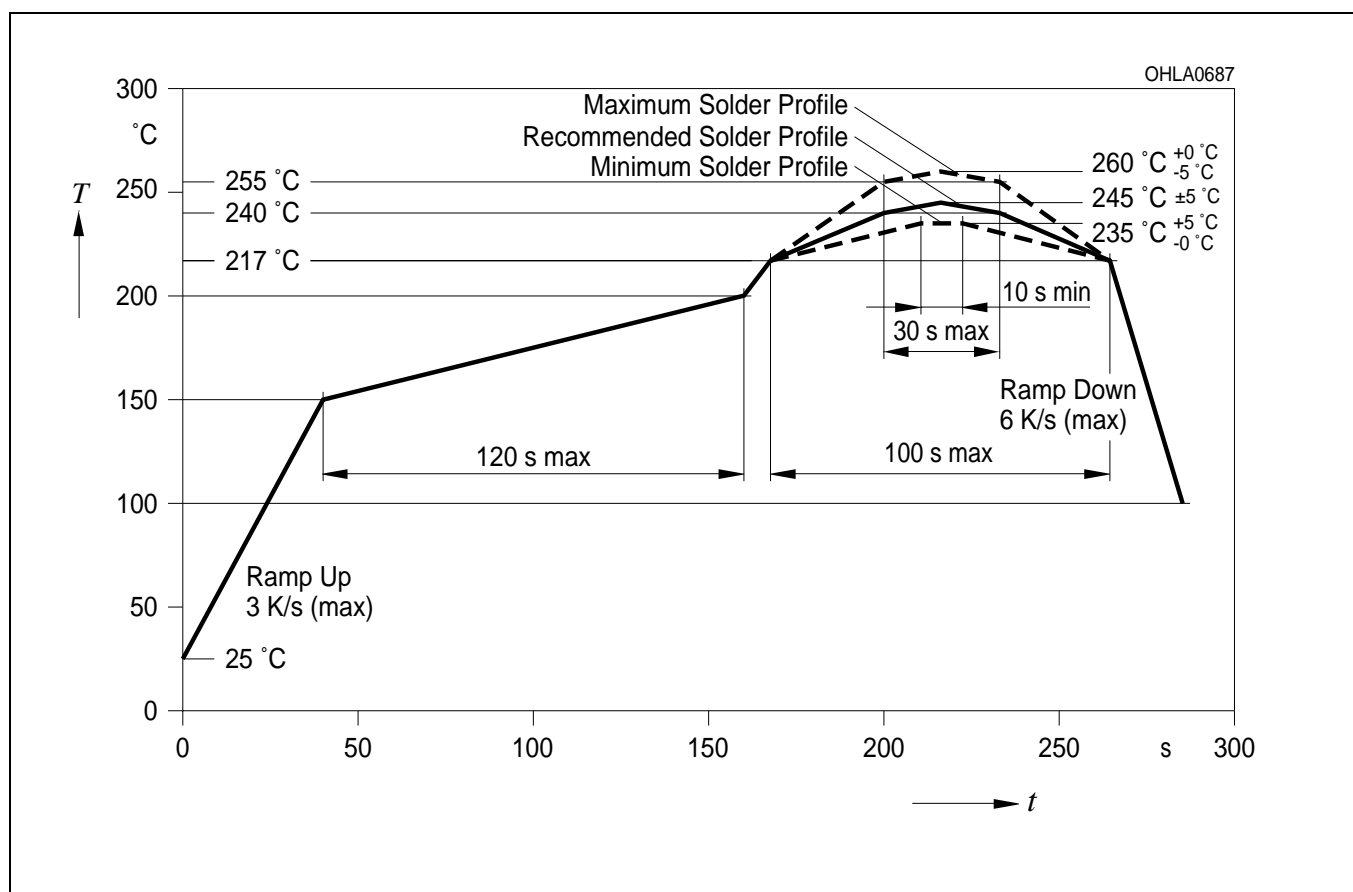

Gurtung / Polarität und Lage

siehe Dokument: Short Form Katalog: Gurtung und
Verpackung - SMT-Bauelemente - Gehäuse:SMT RLS

Methode of Taping / Polarity and Orientation see document: Short Form Catalog: Tape and Reel -
SMT-Components - Package: SMT-RLS

Published by
OSRAM Opto Semiconductors GmbH
Wernerwerkstrasse 2, D-93049 Regensburg
www.osram-os.com

© All Rights Reserved.

The information describes the type of component and shall not be considered as assured characteristics.
Terms of delivery and rights to change design reserved. Due to technical requirements components may contain dangerous substances. For information on the types in question please contact our Sales Organization.

Packing

Please use the recycling operators known to you. We can also help you – get in touch with your nearest sales office. By agreement we will take packing material back, if it is sorted. You must bear the costs of transport. For packing material that is returned to us unsorted or which we are not obliged to accept, we shall have to invoice you for any costs incurred.

Components used in life-support devices or systems must be expressly authorized for such purpose! Critical components¹, may only be used in life-support devices or systems² with the express written approval of OSRAM OS.

¹ A critical component is a component used in a life-support device or system whose failure can reasonably be expected to cause the failure of that life-support device or system, or to affect its safety or effectiveness of that device or system.

² Life support devices or systems are intended (a) to be implanted in the human body, or (b) to support and/or maintain and sustain human life. If they fail, it is reasonable to assume that the health of the user may be endangered