

Lighted Pushbutton Switch

A3C

Cylindrical 12-dia. Series with Superb Operability, High Visibility, and Compact Housing

- Three models of Pushbuttons (round, square, and rectangular), two types of light-emitting elements (LED lamp and incandescent lamp), and two types of Switches (switching standard loads and microloads) available.
- Models that can be used as an indicator also available.
- Requires only 20 mm mounting depth
- Efficiency in wiring improved by terminals arranged on the same surface.
- All LED lamps, incandescent lamps, caps, and legends replaceable without tools.
- UL (E41515) and CSA (LR45258) approved.



Ordering Information

Model Number Legend

When placing your order, specify the individual component part model numbers of the Pushbutton, Lamp (lighted models only), and Switch, as listed in the ordering tables below.

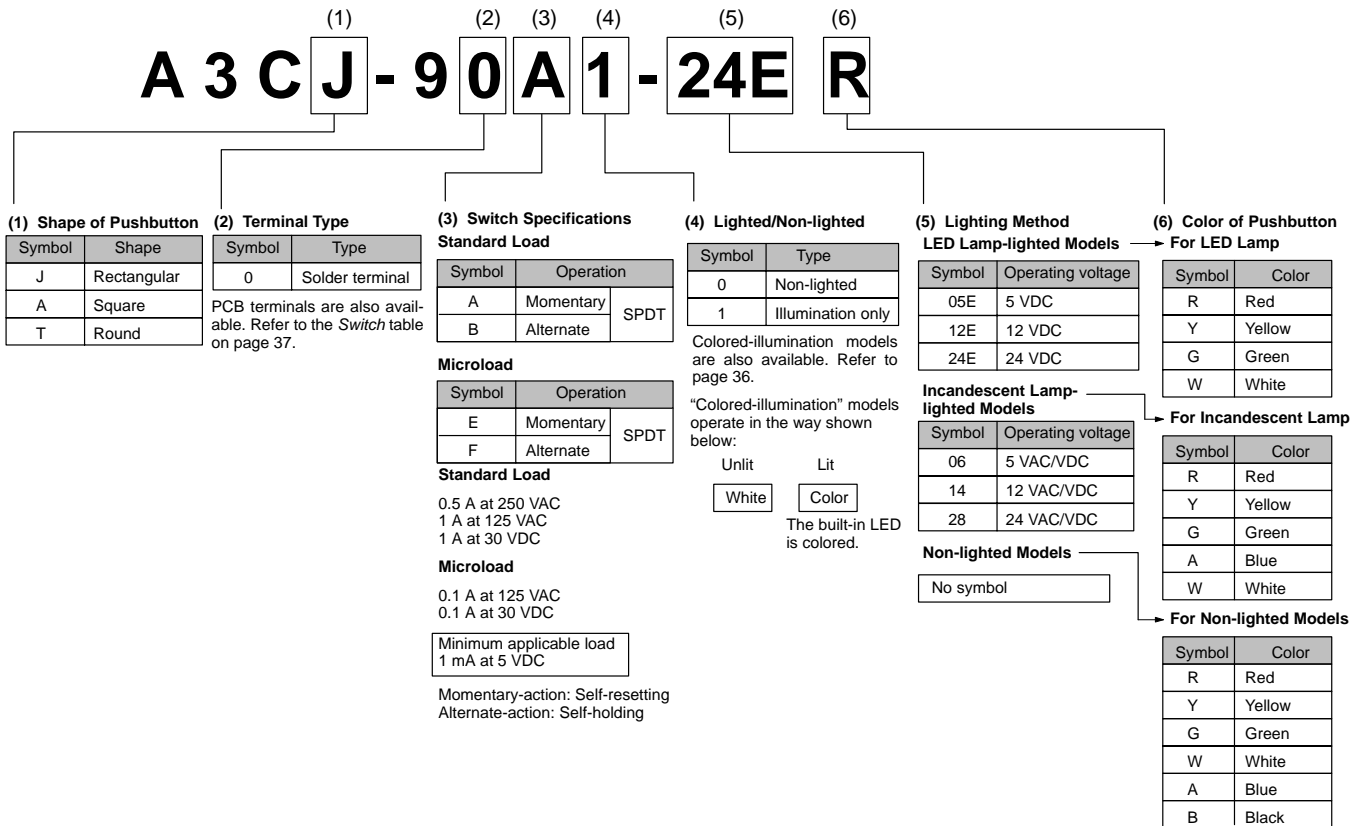

■ Ordering as a Set

The model numbers used to order sets of Units are given in the following tables. One set comprises the Pushbutton, Lamp (lighted models only), and Switch.

Rectangular Models

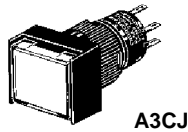

A3CJ

Square Models

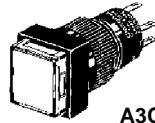

A3CA

Round Models

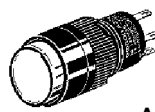

A3CT

Lighted Pushbutton Switches (SPST-NO+SPST-NC Solder Terminals)

| Shape | Contact type Operation Lighting | Standard load | | Microload | Pushbutton color symbol |
|--------------------|---------------------------------------|--|--|--|--|
| | | Momentary operation (Self-resetting) | Alternate operation (Self-holding) | Momentary operation (Self-resetting) | |
| Rectangular (A3CJ) | LED lamp | A3CJ-90A1-05E□ | A3CJ-90B1-05E□ | A3CJ-90E1-05E□ | R: red Y: yellow G: green W: white |
| | | A3CJ-90A1-12E□ | A3CJ-90B1-12E□ | A3CJ-90E1-12E□ | |
| | | A3CJ-90A1-24E□ | A3CJ-90B1-24E□ | A3CJ-90E1-24E□ | |
| | Incandescent lamp | A3CJ-90A1-06□ | --- | | R: red Y: yellow G: green W: white A: blue B: black (See note 3.) |
| | | A3CJ-90A1-14□ | | | |
| | | A3CJ-90A1-28□ | | | |
| | Non-lighted | A3CJ-90A0-□ | A3CJ-90B0-□ | A3CJ-90E0-□ | |
| Square (A3CA) | LED lamp | A3CA-90A1-05E□ | A3CA-90B1-05E□ | A3CA-90E1-05E□ | R: red Y: yellow G: green W: white |
| | | A3CA-90A1-12E□ | A3CA-90B1-12E□ | A3CA-90E1-12E□ | |
| | | A3CA-90A1-24E□ | A3CA-90B1-24E□ | A3CA-90E1-24E□ | |
| | Incandescent lamp | A3CA-90A1-06□ | --- | | R: red Y: yellow G: green W: white A: blue B: black (See note 3.) |
| | | A3CA-90A1-14□ | | | |
| | | A3CA-90A1-28□ | | | |
| | Non-lighted | A3CA-90A0-□ | A3CA-90B0-□ | A3CA-90E0-□ | |
| Round (A3CT) | LED lamp | A3CT-90A1-05E□ | A3CT-90B1-05E□ | A3CT-90E1-05E□ | R: red Y: yellow G: green W: white |
| | | A3CT-90A1-12E□ | A3CT-90B1-12E□ | A3CT-90E1-12E□ | |
| | | A3CT-90A1-24E□ | A3CT-90B1-24E□ | A3CT-90E1-24E□ | |
| | Incandescent lamp | A3CT-90A1-06□ | --- | | R: red Y: yellow G: green W: white A: blue B: black (See note 3.) |
| | | A3CT-90A1-14□ | | | |
| | | A3CT-90A1-28□ | | | |
| | Non-lighted | A3CT-90A0-□ | A3CT-90B0-□ | A3CT-90E0-□ | |

- Note:**
1. Enter the desired color symbol for the Pushbutton in the □ at the end of the model number.
 2. There are also alternate-operation models that can be used for microloads. Refer to the *Switch* table on page 37.
 3. Black ("B") Pushbuttons are only available for non-lighted models.

■ Illumination-only and Colored-illumination LED Models

“Illumination only” describes LED models for which the screen color is the same whether the LED is lit or not. The screen simply becomes brighter when the LED lights.

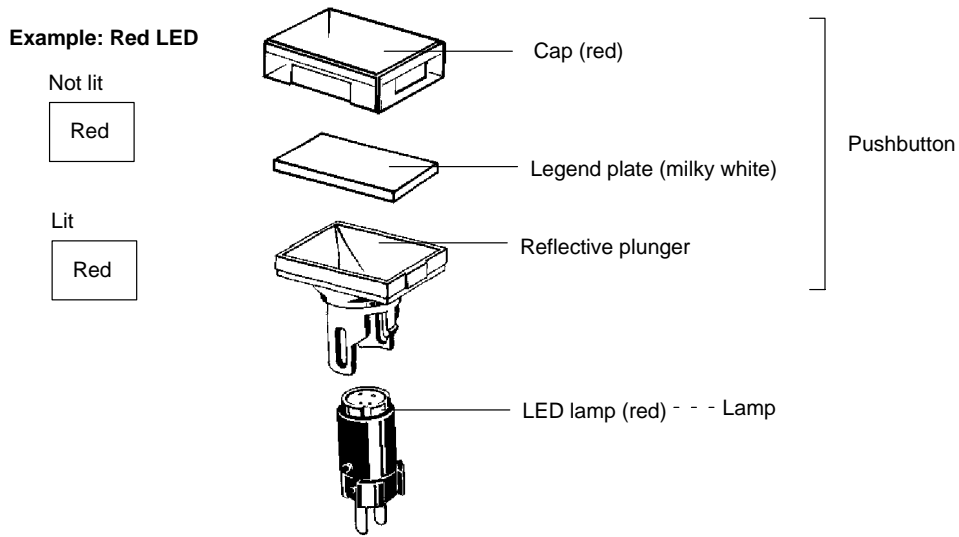

“Colored illumination” describes LED models for which the screen color is white when the LED is not lit and changes to the color of the LED lamp when the LED is lit.

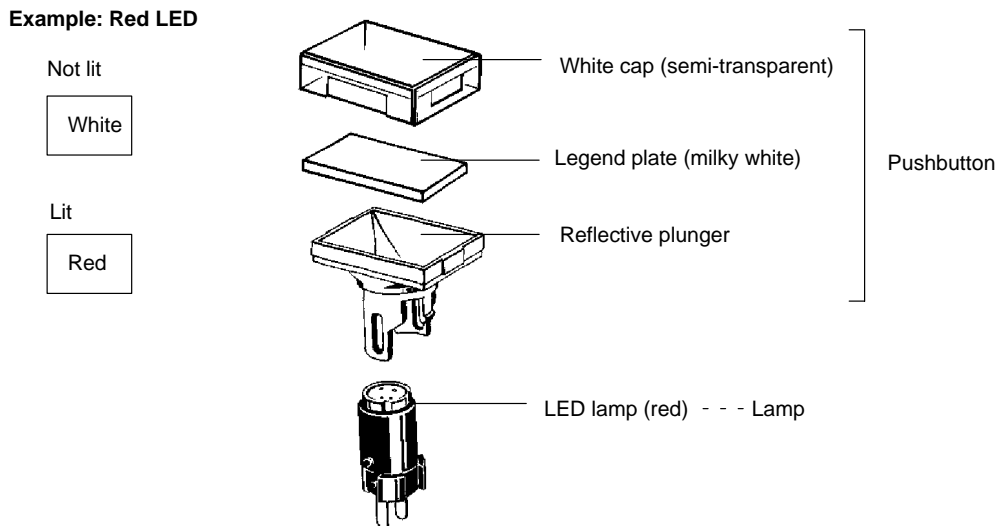

Ordering: With colored-illumination models, order the Pushbutton, Lamp, and Switch as shown in the following table.



| Illuminated color | Pushbutton | Lamp (LED) | | Switch |
|-------------------|---|------------|--|--|
| Red | IP40 A3C□-500W | A16-□DR | Enter one of the following symbols in □. 5: 5 VDC 12: 12 VDC 24: 24 VDC | Refer to the following information. Order the Switch that is appropriate for the Pushbutton. |
| Yellow | Enter one of the following symbols in □. J: Rectangular A: Square T: Round | A16-□DY | | |
| Green | | A16-□DG | | |

■ Ordering Individually

Pushbuttons, Lamps, and Switches can be ordered separately. Combinations that are not available as sets can be created using individual Units. Also, store the parts as spares for maintenance and repairs.

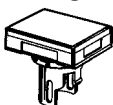

Pushbuttons

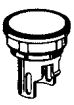
LED Lamp

| Button color | Rectangular | Square | Round |
|---------------|---|---|---|
| |  |  |  |
| Red | A3CJ-500R | A3CA-500R | A3CT-500R |
| Yellow | A3CJ-500Y | A3CA-500Y | A3CT-500Y |
| Green | A3CJ-500GY | A3CA-500GY | A3CT-500GY |
| White | A3CJ-500W | A3CA-500W | A3CT-500W |

Note: The red, yellow, and white Pushbuttons listed above can be used with either LED lamp-lighted models or incandescent lamp-lighted models.

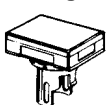
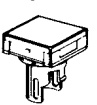
Non-lighted Models

| Button color | Rectangular | Square | Round |
|---------------|---|---|---|
| |  |  |  |
| Red | A3CJ-500R | A3CA-500R | A3CT-500R |
| Yellow | A3CJ-500Y | A3CA-500Y | A3CT-500Y |
| Green | A3CJ-500G | A3CA-500G | A3CT-500G |
| White | A3CJ-500W | A3CA-500W | A3CT-500W |
| Blue | A3CJ-500A | A3CA-500A | A3CT-500A |
| Black | A3CJ-501B | A3CA-501B | A3CT-501B |

Incandescent Lamp

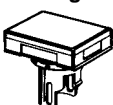
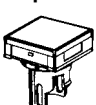
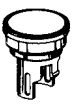
| Button color | Rectangular | Square | Round |
|---------------|---|---|---|
| |  |  |  |
| Red | A3CJ-500R | A3CA-500R | A3CT-500R |
| Yellow | A3CJ-500Y | A3CA-500Y | A3CT-500Y |
| Green | A3CJ-500G | A3CA-500G | A3CT-500G |
| White | A3CJ-500W | A3CA-500W | A3CT-500W |
| Blue | A3CJ-500A | A3CA-500A | A3CT-500A |

Lamps



LED Lamp

| Color | Rated voltage | | |
|---------------|---------------|----------|----------|
| | 5 VDC | 12 VDC | 24 VDC |
| Red | A16-5DR | A16-12DR | A16-24DR |
| Yellow | A16-5DY | A16-12DY | A16-24DY |
| Green | A16-5DG | A16-12DG | A16-24DG |
| White | A16-5DW | A16-12DW | A16-24DW |











Incandescent Lamp

| Rated voltage | 6 VAC/VDC | 14 VAC/VDC | 28 VAC/VDC |
|---------------|-----------|------------|------------|
| Model | A16-5 | A16-12 | A16-24 |

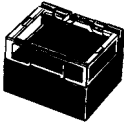
Switches

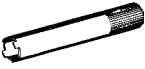
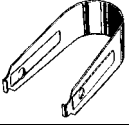
| Configuration | Contact | Switch action | Terminal | Degree of protection: IP40 | | |
|---------------|---------------------|---------------|----------|--|---|---|
| | | | | Rectangular | Square | Round |
| Standard | SPST-NO+ SPST-NC | Momentary | Solder |  |  |  |
| | | Alternate | | A3CJ-7011 | A3CA-7011 | A3CT-7011 |
| Microload | | Momentary | | A3CJ-7021 | A3CA-7021 | A3CT-7021 |
| | | Alternate | | A3CJ-7111 | A3CA-7111 | A3CT-7111 |
| | | | | A3CJ-7121 | A3CA-7121 | A3CT-7121 |

Accessories (Order Separately)

| Name | Appearance | Classification | Model | Remarks |
|------------------|---|--------------------------|-----------|---|
| Socket |  | Wire-wrap terminal | A3C-4101 | Cannot be used with Insulation Cover. |
| |  | PCB terminal | A3C-4102 | |
| |  | Solder terminal | A3C-4103 | |
| Insulation Cover |  | --- | A3C-3002 | Cannot be used with Socket. |
| Switch Guard |  | For rectangular models | A3CJ-5050 | Cannot be used with Dust Cover. |
| | | For square, round models | A3CA-5050 | |
| Dust Cover |  | For rectangular models | A3CJ-5060 | Cannot be used with Switch Guard. |
| Tightening Tool |  | --- | A3C-3004 | The tightening torque is 0.20 to 0.39 N·m. |
| Extractor |  | --- | A3PJ-5080 | --- |
| Legend Plate |  | For rectangular models | A3CJ-5201 | One Legend Plate is supplied per standard Switch. |
| |  | For square models | A3CA-5201 | |
| |  | For round models | A3CT-5201 | |

Specifications

■ Contact Ratings

| Model | Item | |
|----------------------------|------------------------------------|-------------------|
| | AC resistive load | DC resistive load |
| Standard load | 0.5 A at 250 VAC 1 A at 125 VAC | 1 A at 30 VDC |
| Microload (See note 1.) | 0.1 A at 125 VAC | 0.1 A at 30 VDC |

- Note:**
- The minimum permissible load is 1 mA, 5 VDC.
 - The above ratings are for testing under the following conditions:
 - Load: Resistive load
 - Mounting conditions: No vibrations or shock
 - Temperature: 20°C ± 2°C
 - Operation frequency: 20 operations/minute

■ LED Lamp Ratings

| Rated voltage | Rated current | Operating voltage | Internal limiting resistance |
|---------------|---------------|-------------------|------------------------------|
| 5 VDC | 30 mA | 5 VDC±5% | 33 Ω |
| 12 VDC | 15 mA | 12 VDC±5% | 270 Ω |
| 24 VDC | 10 mA | 24 VDC±5% | 1,600 Ω |

■ Incandescent Lamp Ratings

| Rated voltage | Rated current | Operating voltage |
|---------------|---------------|-------------------|
| 6 VAC/VDC | 60 mA | 5 VAC/VDC |
| 14 VAC/VDC | 40 mA | 12 VAC/VDC |
| 28 VAC/VDC | 24 mA | 24 VAC/VDC |

■ Characteristics

| | |
|--|--|
| Operating frequency | Mechanical: Momentary-action models: 120 operations/minute max. Alternate-action models: 60 operations/minute max. (See note 1.) Electrical: 20 operations/minute max. |
| Insulation resistance | 100 MΩ min. (at 500 VDC) |
| Dielectric strength | 1,000 VAC, 50/60 Hz for 1 minute between terminals of same polarity and between lamp terminals (See note 2.) 2,000 VAC, 50/60 Hz for 1 minute between terminals of different polarity and also between each terminal and ground |
| Vibration | Malfunction: 10 to 55 Hz, 1.5-mm double amplitude (No malfunctions for more than 1 s.) |
| Shock | Destruction: 500 m/s ² Malfunction: 150 m/s ² (No malfunctions for more than 1 s.) |
| Life expectancy | Mechanical: Momentary-action models: 1,000,000 operations min. Alternate-action models: 100,000 operations min. (See note 1.) Electrical: 100,000 operations min. |
| Weight | Approx. 5 g (See note 3.) |
| Ambient operating temperature | -10°C to 55°C (with no icing or condensation) |
| Ambient operating humidity | 35% to 85% |
| Ambient storage temperature | -25°C to 65°C |
| Degree of protection | IP40 |
| Electric shock protection class | Class II |
| PTI (proof tracking index) | 175 |
| Pollution degree | 3 (IEC947-5-1) |

- Note:**
1. With alternate-operation models, one operation cycle consists of set and reset operations.
 2. The figure given above for the dielectric strength between lamp terminals is for when there is no LED lamp or incandescent lamp mounted.
 3. The weight indicated here applies to the lighted models (SPST-NO+SPST-NC).

■ Operating Characteristics

| | |
|---------------------------------|----------------|
| OF max. | 2.45 N |
| RF min. | 0.29 N |
| TT | Approx. 3.5 mm |
| LTA min. (See note.) | 0.5 mm |
| PT max. | 2.5 mm |

Note: The value for LTA min. applies to alternate-operation models only.

■ Approved by Standards

UL (File No. E41515)
CSA (File No. LR45258-31)

Rating Standard

1 A at 125 VAC
0.5 A at 250 VAC
1 A at 30 VDC

Microload

0.1 A at 125 VAC
0.1 A at 30 VDC

■ Contact Form

| Contact name | Contact form |
|--------------|--------------|
| SPDT | |

Nomenclature

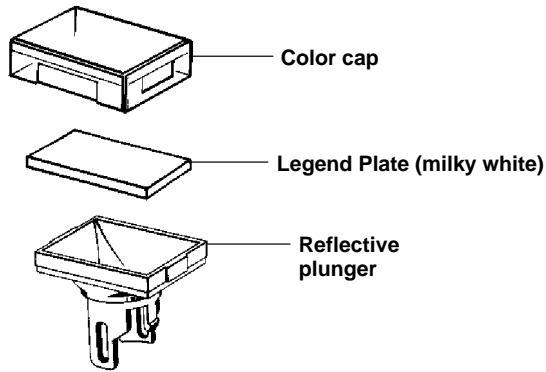

Pushbutton

Shape of Pushbutton

Rectangular (A3CJ)



Square (A3CA)



Round (A3CT)

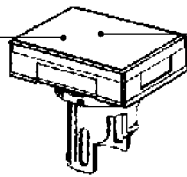

Color of Pushbutton

- LED lamp-lighted Models:
Red, yellow, green, white
- Incandescent lamp-lighted Models:
Red, yellow, green, white, blue
- Non-lighted Models:
Red, yellow, green, white, blue, black

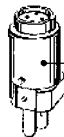

Lamp
LED Lamp



Incandescent Lamp

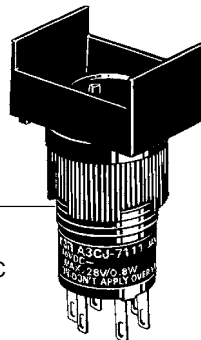

Switch

- Standard load:
0.5 A at 250 VAC
1 A at 125 VAC
1 A at 30 VDC
- Microload:
0.1 A at 125 VAC,
0.1 A at 30 VDC
Minimum applicable load: 1 mA at 5 VDC

Note: The A3CJ model is shown here as a representative example.

Dimensions

The following dimensions apply to the Switch with SPST-NO+SPST-NC contact configuration, with solder terminals.

Rectangular Models A3CJ

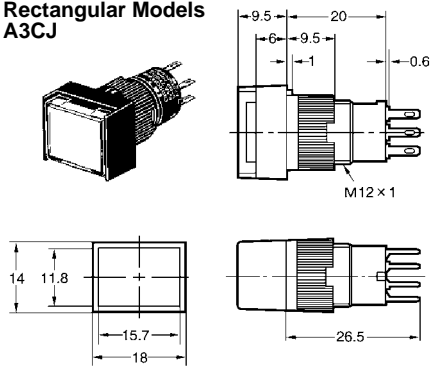

Square Models A3CA

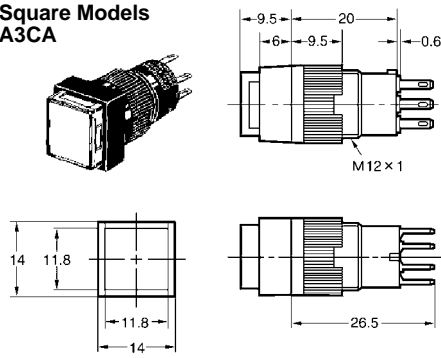

Round Models A3CT

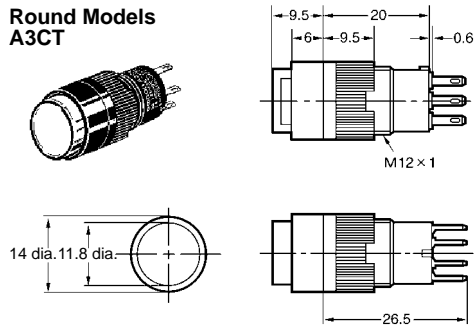

■ Accessory Mounting Dimensions Dimensions with Socket Mounted

The diagrams below show the external dimensions for rectangular models as representative models.

**Wire-wrap Terminal
A3C-4101**

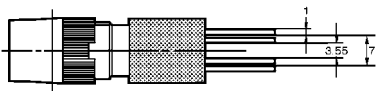
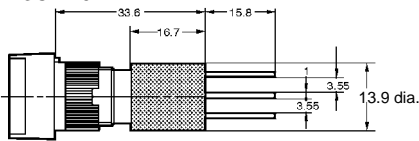

**PCB Terminal
A3C-4102**

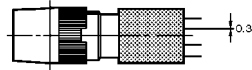
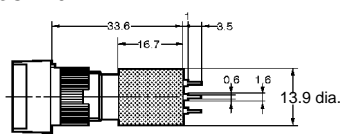

PCB Cutout (bottom view)

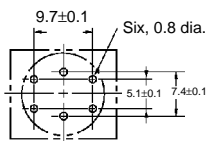

**Solder Terminal
A3C-4103**

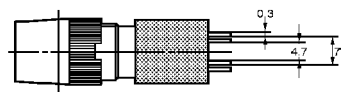
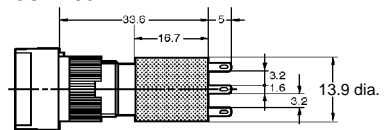

Terminal Hole Dimensions

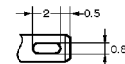

Switch Guard

**Rectangular
A3CJ-5050**

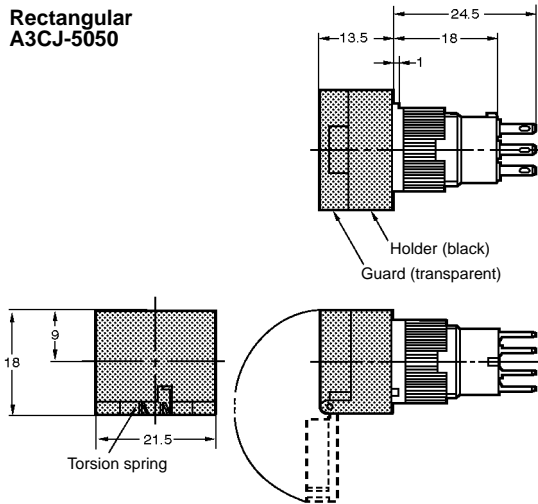

**Square/Round
A3CA-5050**

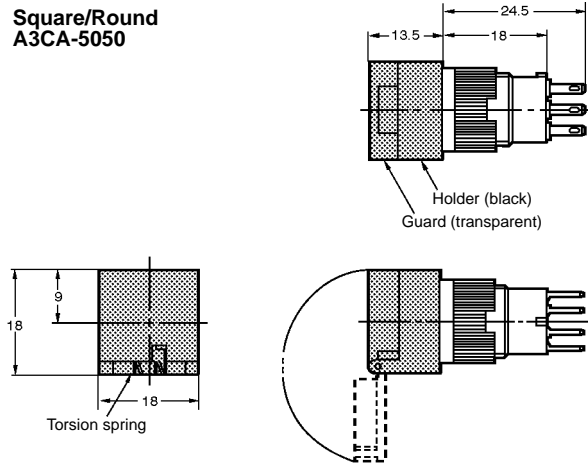

**Dust Cover
A3CJ-5060**

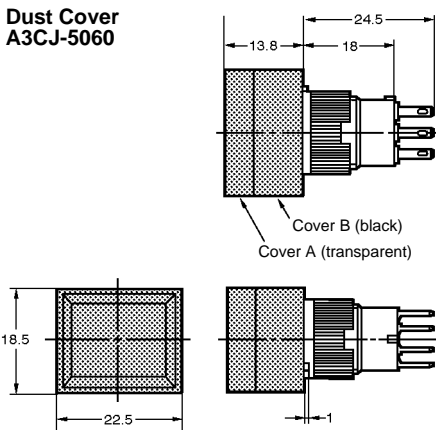

Legend Plate

Rectangular

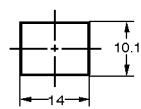

Square

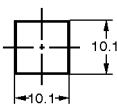

Round

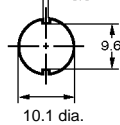

- Note:**
1. The thickness is 0.8 mm.
 2. Since the Legend Plate is made of polycarbonate, use alcohol-based paints such as melanin, phthalic acid, or acryl paint when marking the legend.

**Insulation Cover
A3C-3002**

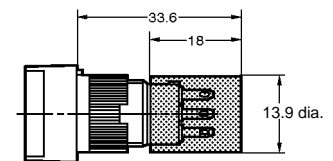

■ Panel Cutout (Top View)

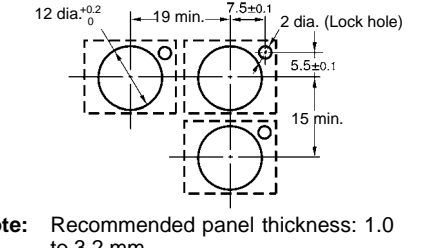
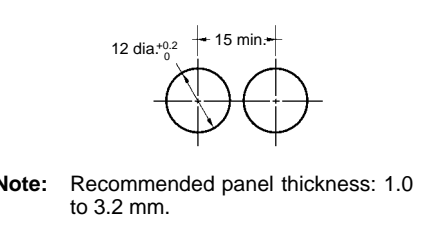
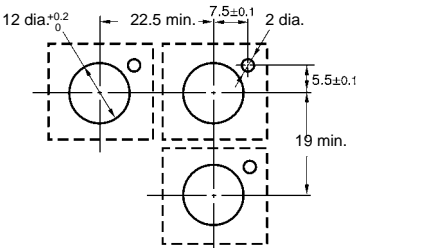
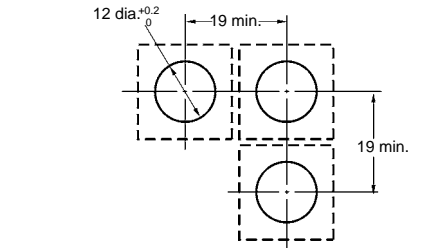
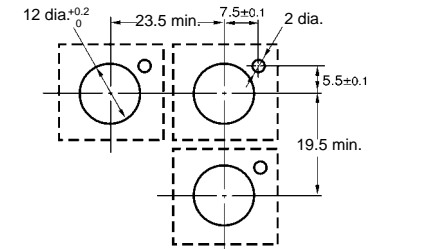
| Accessories used | Rectangular/A3CJ | Square/A3CA, Round/A3CT |
|-------------------|---|---|
| Switch only |  <p>Note: Recommended panel thickness: 1.0 to 3.2 mm.</p> |  <p>Note: Recommended panel thickness: 1.0 to 3.2 mm.</p> |
| With Switch Guard |  <p>Note: Recommended panel thickness: 1.0 to 3.2 mm.</p> |  <p>Note: Recommended panel thickness: 1.0 to 3.2 mm.</p> |
| With Dust Cover |  <p>Note: Recommended panel thickness: 1.0 to 3.2 mm.</p> | <p>---</p> |

Note: If the panel is to be finished (e.g., coated), make sure that the panel meets the specified dimensions after the coating.

Operation

■ Terminal Connections

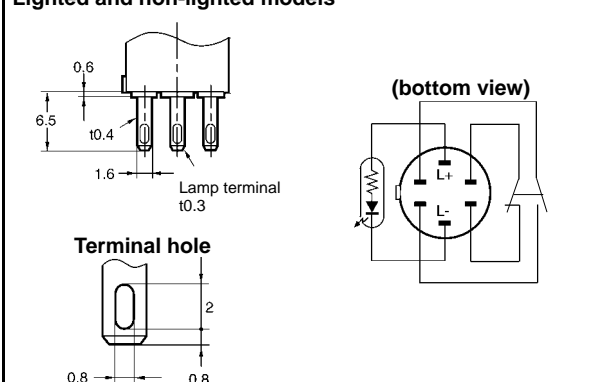
| Terminal | Type |
|-----------------|--|
| | SPST-NO+SPST-NC |
| Solder terminal | <p>Lighted and non-lighted models</p>  |

Installation

Mounting and Replacing the Pushbutton

Mounting Direction for the Pushbutton/Display and Lamp

Lighted Pushbutton Switch

- Insert the Lamp (incandescent lamp or LED lamp) into the Pushbutton so that the lamp guide fits into the wider gap between the projections on the Pushbutton.

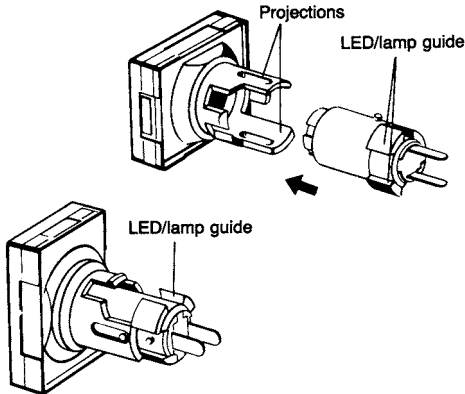

Indicator

- With Indicators, the Lamp is inserted facing the opposite direction (i.e., at 180°) to that for Lighted Pushbutton Switches.

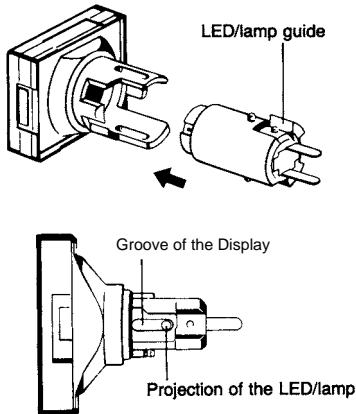

- Note:**
1. Push the projections on the Lamp into the grooves on the Pushbutton/Display.
 2. The Lamp for Lighted Pushbutton Switches moves, but the Lamp for Indicators is fixed.

Mounting Direction for the Pushbutton/Display and Switch

Insert the Pushbutton/Display into the Switch so that the lamp guide is aligned with the non-projecting part of the Switch.

Apply a pressure between 9.8 and 24.5 N.

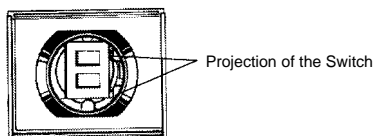

- Note:**
1. The mounting direction for Indicators is 180° to that for Lighted Pushbutton Switches. Be sure to insert the Legend Plate and other parts with the correct orientation.

2. If the terminals of the Lamp become bent, it may be impossible to fit them into the lamp terminal holes. Ensure that the terminals are straight when they are inserted.
3. Take particular care about the mounting direction with the round models (A3CT).

Removing the Pushbutton/Display

Hold the recessed portions on the cap of the Pushbutton and pull.

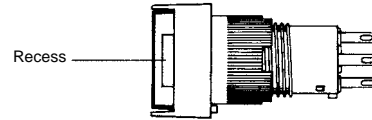

Note: Do not use tools such as pliers to remove the Pushbutton as this may damage the cap.

Panel Mounting

Insert the Switch from the front of the panel. Mount the mounting nut from the terminal end of the Switch and tighten it.

There are projections on the terminal end of the Switch which may, depending on the orientation, block the nut. In this case, turn the nut until it is possible to mount it. Tighten the nut to a torque between 0.20 and 0.39 N·m.

If soldering is used, mount the mounting nut first. Lead wires and mounds of solder may make it impossible to mount the nut after soldering.

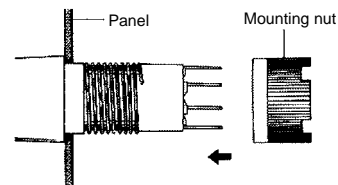

Socket Mounting

After securing the Switch to the panel using the mounting nut, insert the Socket into the Switch.

Align the positioning holes of the Socket with the projections of the Switch before inserting the Socket.

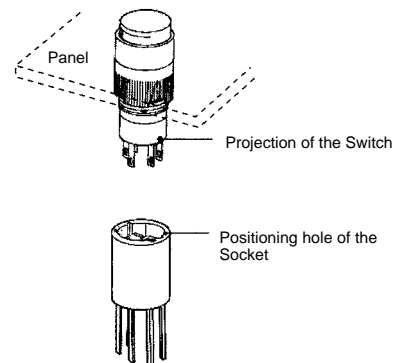

Mounting the Insulation Cover

After securing the Switch to the panel using the mounting nut, pass the lead wires through the holes in the Insulation Cover and then perform wiring. Hold the Insulation Cover so that the cylindrical hole is facing the Switch, and insert the lead wires from the end with the barriers.

After wiring is completed, mount the Insulation Cover by pushing it into the Switch.

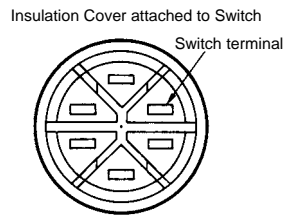

Mounting the Dust Cover

1. The Dust Cover separates into 2 parts: the cap and the mounting frame.
2. Insert the Switch into the mounting frame. (Align the lock projection with the recess on the mounting frame.)
3. Insert the Switch in the state described in step 2 into the panel. (Align the lock protrusion on the mounting frame with the hole in the panel.)
4. Mount the mounting nut from the back of the panel and tighten it.
5. Insert the cap into the mounting frame. Ensure that the entire perimeter of the cap is properly inserted into the mounting frame by pressing down on the cap from different directions.

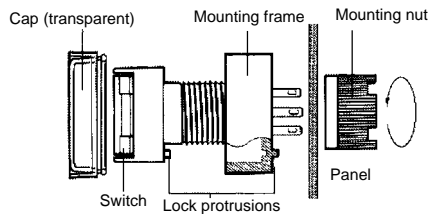

Mounting the Switch Guard

1. Insert the Switch into the Switch Guard.
2. Insert the Switch into the panel in the state described in step 1.
3. Mount the mounting nut from the back of the panel and tighten it.

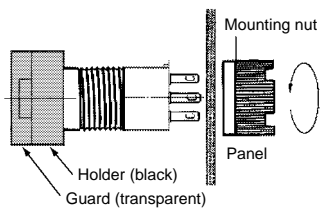

Precautions

Caution

Do not apply a voltage higher than the maximum rated operating voltage between the lamp terminals, as there is a risk that the incandescent lamp or LED lamp will be damaged, and the Pushbutton will be ejected.

When replacing the incandescent lamp, first turn OFF the power supply, and then wait 10 minutes before performing replacement, as the lamp is still hot immediately after the power is turned OFF, so there is a risk of burns.

Refer to the *Common Precautions* for Pushbutton Switches on page 14.

Correct Use

Mounting

To prevent electric shock or a fire, always make sure that the power is turned OFF before mounting, removing, or wiring the Switch, or performing maintenance.

Do not tighten the mounting ring excessively using pliers or a similar tool. Excessive tightening may damage the mounting ring. (Tightening torque: 0.20 to 0.39 N·m)

Wiring

When wiring, use wires of a size appropriate for the applied voltage and carry current. Perform soldering correctly under the conditions given below. Using the Switch with the wires soldered incorrectly may cause the terminals to become abnormally hot and cause a fire.

1. Hand soldering: At 30 W within 5 seconds.
2. Dip soldering: At 240°C within 3 seconds.

Wait for one minute after soldering before exerting any external force on the solder.

Use a non-corrosive rosin liquid for the flux.

Perform wiring so that the wire sheaths do not come into contact with the Switch. If this is unavoidable, use wires that can withstand temperatures of 100°C min.

After wiring to the Switch has been completed, ensure an appropriate insulation distance.

Operating Environment

Do not use in locations that are subject to dust, oil, or metal filings as these may penetrate the interior of the Switch and cause malfunction.

Using Microloads

Using a standard load switch for opening and closing a microload circuit may cause wear on the contacts. Use the switch within the operating range. (Refer to the diagram below.) Even when using microload models within the operating range shown below, if inrush current occurs when the contact is opened or closed, it may cause the contact surface to become rough, and so decrease life expectancy. Therefore, insert a contact protection circuit where necessary. The minimum applicable load is the N-level reference value. This value indicates the malfunction reference level for the reliability level of 60% ($\lambda 60$) (conforming to JIS C5003). The equation, $\lambda 60 = 0.5 \times 10^{-4}$ times indicates that the estimated malfunction rate is less than 1/2,000,000 with a reliability level of 60%.

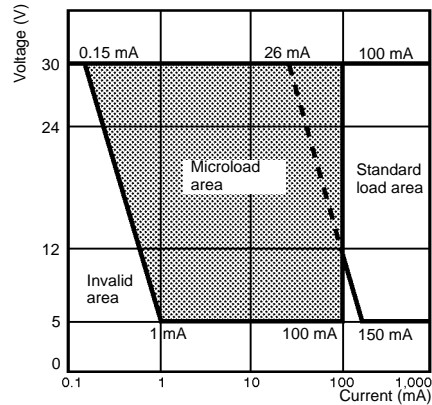

LED

Resistance to limit the LED current is provided internally and so an external resistance is not required.

| Rated voltage | Internal limiting resistance |
|---------------|------------------------------|
| 5 VDC | 33 Ω |
| 12 VDC | 270 Ω |
| 24 VDC | 1600 Ω |

ALL DIMENSIONS SHOWN ARE IN MILLIMETERS.
 To convert millimeters into inches, multiply by 0.03937. To convert grams into ounces, multiply by 0.03527.