

DESCRIPTION: HIGH DENSITY MALE - SOLDER CUP

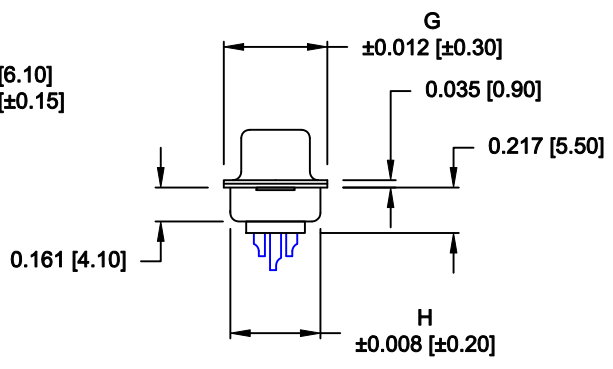
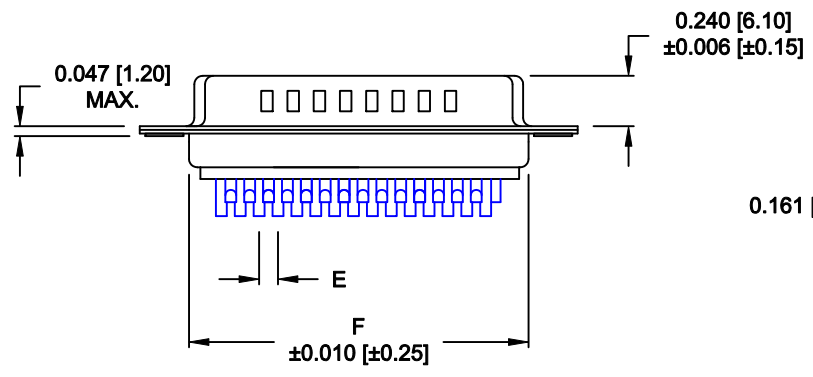
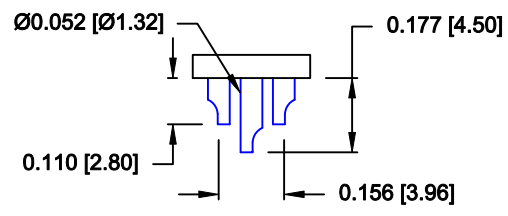
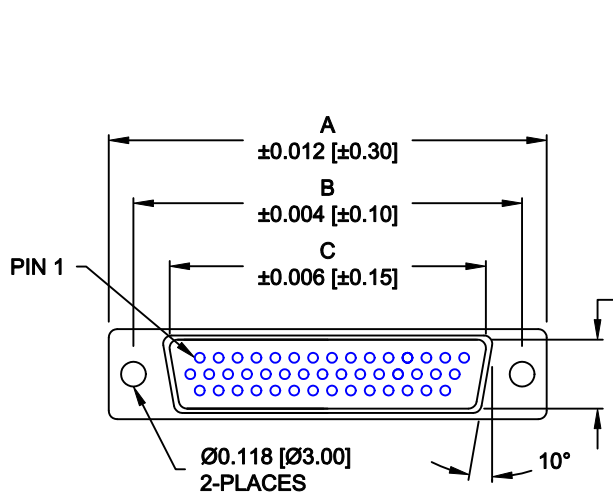

No. OF PINS	DIMENSIONS							
	A	B	C	D	E	F	G	H
15	1.213	0.984	0.666	0.329	0.090	0.756	0.496	0.429
	30.80	24.99	16.92	8.36	2.29	19.20	12.60	10.90
26	1.543	1.312	0.978	0.329	0.090	1.091	0.496	0.429
	39.20	33.32	25.25	8.36	2.29	27.70	12.60	10.90
44	2.087	1.852	1.534	0.329	0.090	1.618	0.496	0.429
	53.00	47.04	38.85	8.36	2.29	41.10	12.60	10.90
62	2.732	2.500	2.181	0.329	0.095	2.256	0.496	0.429
	69.40	63.50	55.40	8.36	2.41	57.30	12.60	10.90
78	2.638	2.406	2.079	0.445	0.095	2.169	0.606	0.526
	67.00	61.10	52.80	11.30	2.41	55.10	15.40	13.35

4 ROWS

180-YYY-10YLYY1

- SERIES _____
- POSITIONS _____
- 015 _____
- 026 _____
- 044 _____
- 062 _____
- 078 _____
- GENDER _____
- 1 = MALE
- TERMINATION _____
- 0 = SOLDER CUP
- SHELL PLATING _____
- 2 = TIN
- 3 = NICKEL (GROUND INDENTS)
- RoHS COMPLIANT (230°C) _____
- HARDWARE OPTIONS _____
- 00 = NO HARDWARE
- 01 = .098" CLINCH NUT (BOARD SIDE)
- 02 = .236" CLINCH NUT (BOARD SIDE)
- 03 = .236" CLINCH NUT (MATING SIDE)
- PLATING OPTIONS _____
- 1 = GOLD FLASH
- 2 = 30u" GOLD

MATERIAL:

- SHELL: STEEL, TIN OR NICKEL PLATED
- INSULATOR: PBT, UL 94V-O RATED, +30% FIBER-GLASS OR NYLON-66
- CONTACT: BRASS, GOLD PLATED OVER NICKEL

ELECTRICAL:

- CURRENT RATING: 5 AMPS
- CONTACT RESISTANCE: 15 mOhms Max.
- INSULATION RESISTANCE: 1,000 MOhms min.
- VOLTAGE: 500VAC FOR 1 MINUTE
- TEMPERATURE: -50° C TO 100° C

NOTE: WILL ACCEPT UP TO 24 AWG WIRE

DO NOT SCALE FROM DRAWING

RoHS COMPLIANT

	THESE DRAWINGS AND SPECIFICATIONS ARE THE PROPERTY OF NorComp AND SHALL NOT BE REPRODUCED, COPIED OR USED AS THE BASIS FOR THE MANUFACTURE OF SALE OF APPARATUS WITHOUT WRITTEN PERMISSION.		DRAWN: WAYNE ROBBINS	DATE: 11-29-05
			CHECKED:	DATE:
<h1>NorComp</h1>		SCALE: 1 : 1	SHEET 1 OF 2	REV 12
		DWG NO. 180-YYY-10YLYY1		

ALL CLINCH-NUTS ARE 4-40 INTERNAL THREADS

01X 0.098" (BOARD SIDE) - CN1

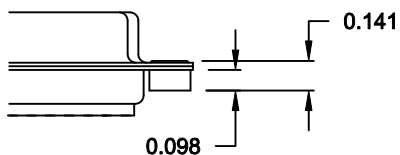

02X 0.236" (BOARD SIDE) - CN2

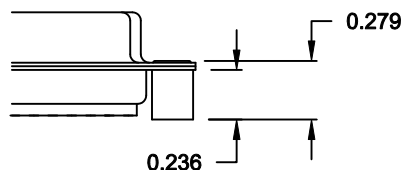

03X..... 0.236" (MATING SIDE) - CN8

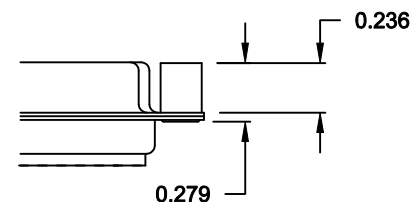

DO NOT SCALE FROM DRAWING

	THESE DRAWINGS AND SPECIFICATIONS ARE THE PROPERTY OF NorComp AND SHALL NOT BE REPRODUCED, COPIED OR USED AS THE BASIS FOR THE MANUFACTURE OF SALE OF APPARATUS WITHOUT WRITTEN PERMISSION.		DRAWN: C. SMITH	DATE: 03-08-06	
			CHECKED:	DATE:	
NorComp			SCALE: FULL	SHEET 2 OF 2	REV 12
			DWG NO. 180-YYY-10YLYY1		

RoHS COMPLIANT