

SF2137E-1

**869.00 MHz
SAW Filter**

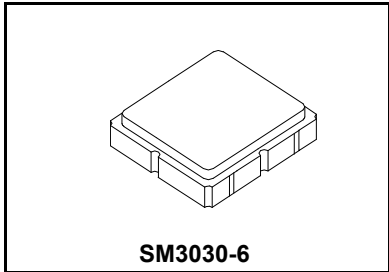

- Steep Roll-off SAW Filter for 869.00 MHz Unlicensed Band
- Complies with Directive 2002/95/EC (RoHS)
- No Matching Required for Operation in 50Ω Environment



Absolute Maximum Ratings

Rating	Value	Units
Input Power Level	14	dBm
DC Voltage on any Non-ground Terminal	5	V
Operating Temperature Range	-30 to +65	°C
Storage Temperature Range in Tape and Reel	-40 to +85	°C
Soldering Profile Maximum Temperature, 5 cycles/10 s maximum	265	°C

Electrical Characteristics

Characteristic	Sym	Notes	Min	Typ	Max	Units
Center Frequency	f_c			869.00		MHz
Insertion Loss, 868 to 870 MHz	IL			2.7	3.5	dB
Amplitude Ripple, 868 to 870 MHz				0.2	1.5	dB _{P-P}
Attenuation Referenced to 0 dB:						
DC to 828 MHz			45	51		dB
828 to 849 MHz			30	40		
881 to 890 MHz			10	18		
890 to 925 MHz			22	38		
925 to 1200 MHz			40	49		
1200 to 1740 MHz			36	49		
Source Impedance	Z_S			50		Ω
Load Impedance	Z_L			50		Ω

Case Style	SM3030-6 3.0 x 3.0 mm Nominal Footprint		
Lid Symbolization, Y=year, WW=week, S=shift, Dot=pin 1 indicator	994, YWWS		
Standard Reel Quantity	Reel Size 7 Inch	500 Pieces/Reel	
	Reel Size 13 Inch	3000 Pieces/Reel	

Electrical Connections

Connection	Terminals
Port 1	2
Port 2	5
Case Ground	All others



CAUTION: Electrostatic Sensitive Device. Observe precautions for handling.

NOTES:

1. Unless noted otherwise, all specifications apply over the operating temperature range with filter soldered to the specified demonstration board with impedance matching to 50 Ω and measured with 50 Ω network analyzer.
2. Unless noted otherwise, all frequency specifications are referenced to the nominal center frequency, f_c .
3. Rejection is measured as attenuation below the minimum IL point in the passband. Rejection in final user application is dependent on PCB layout and external impedance matching design. See Application Note No. 42 for details.
4. The design, manufacturing process, and specifications of this filter are subject to change.
5. US and international patents may apply.
6. Murata, stylized Murata logo, and Murata N.A., Inc. are registered trademarks of Murata Manufacturing Co., Ltd.

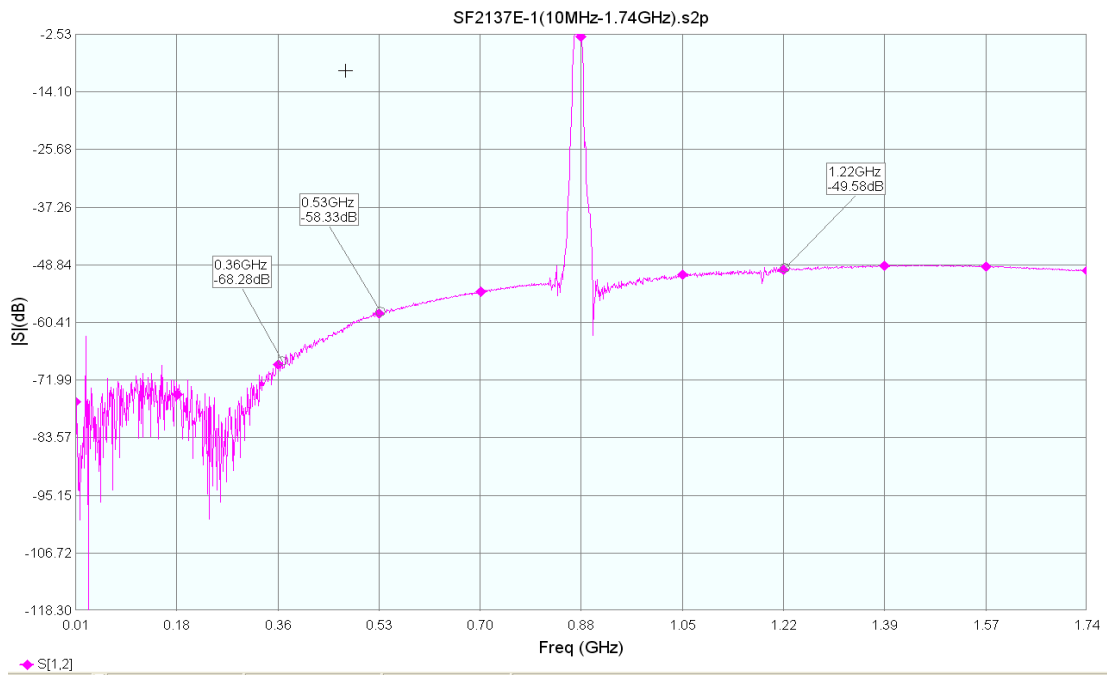
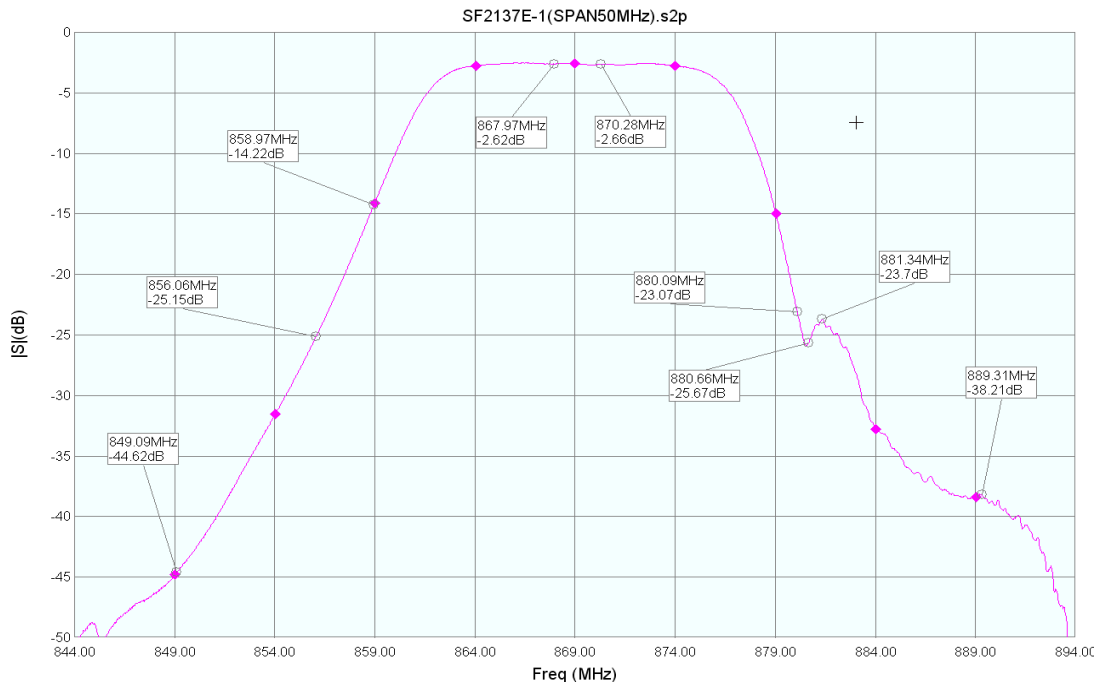

SM3030-6 Case

6-Terminal Ceramic Surface-Mount Case 3.0 X 3.0 mm Nominal Footprint

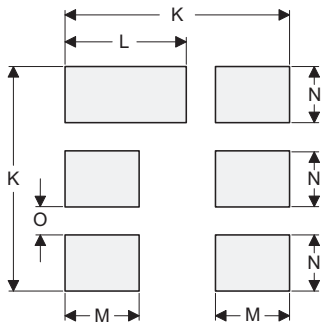
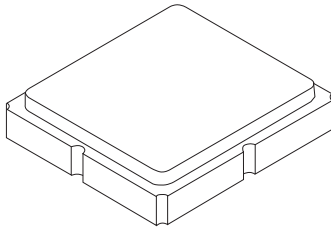

PCB Footprint Top View

Case and PCB Footprint Dimensions

Dimension	mm			Inches		
	Min	Nom	Max	Min	Nom	Max
A	2.87	3.00	3.13	0.113	0.118	0.123
B	2.87	3.00	3.13	0.113	0.118	0.123
C	1.12	1.25	1.40	0.044	0.049	0.055
D	0.77	0.90	1.03	0.030	0.035	0.040
E	2.67	2.80	2.93	0.105	0.110	0.115
F	1.47	1.60	1.73	0.058	0.063	0.068
G	0.72	0.85	0.98	0.028	0.033	0.038
H	1.37	1.50	1.63	0.054	0.059	0.064
I	0.47	0.60	0.73	0.019	0.024	0.029
J	1.17	1.30	1.43	0.046	0.051	0.056
K		3.20			0.126	
L		1.70			0.067	
M		1.05			0.041	
N		0.81			0.032	
O		0.38			0.015	

Case Materials

Materials	
Solder Pad Plating	0.3 to 1.0 μm Gold over 1.27 to 8.89 μm Nickel
Lid Plating	2.0 to 3.0 μm Nickel
Body	Al_2O_3 Ceramic
Pb Free	

Top View

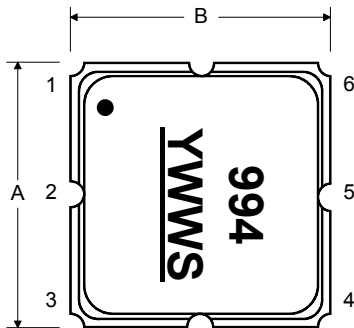

Bottom View

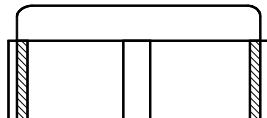
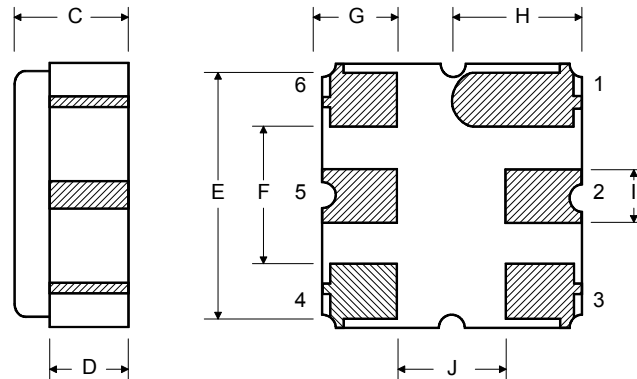

Typical Solder Reflow Profile

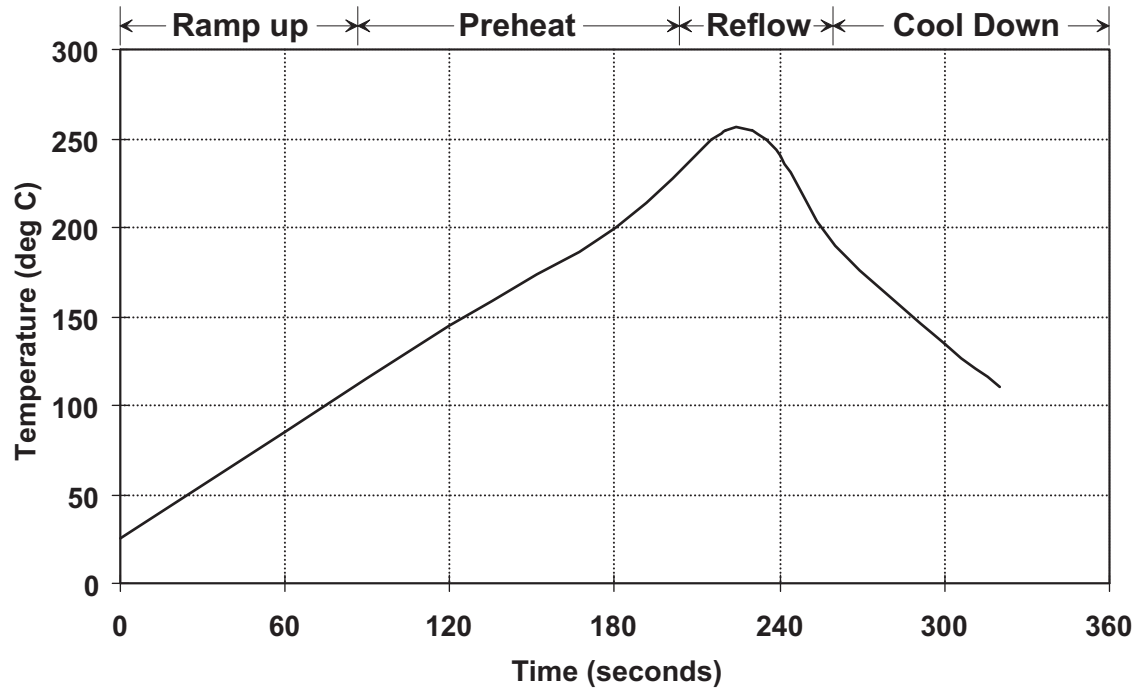

Mouser Electronics

Authorized Distributor

Click to View Pricing, Inventory, Delivery & Lifecycle Information:

[Murata:](#)

[SF2137E-1](#)