

3950X SERIES
3.50mm HEADERS

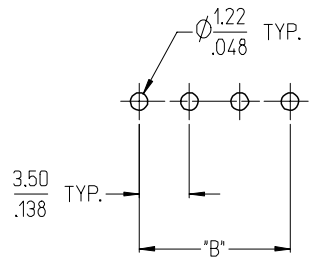

3952X & 3954X SERIES
5.00mm HEADERS
5.00mm 10 AMP FIXED

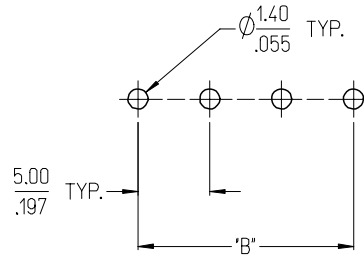

3953X SERIES
5.08mm HEADERS

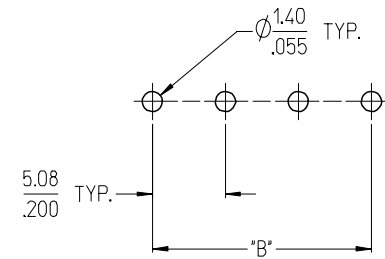

3951X SERIES
3.81mm HEADERS

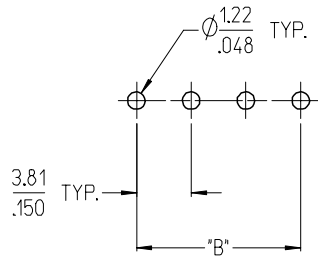

3954X SERIES
5.00mm 15 AMP FIXED

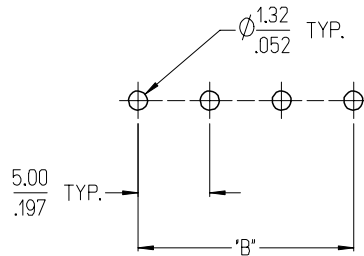

3954X SERIES
5.08mm 15 AMP FIXED

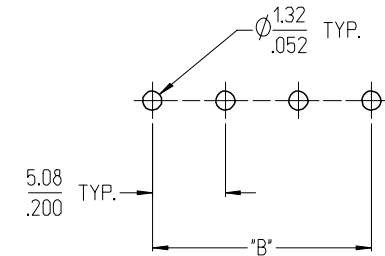

NOTES:

- REFER TO INDIVIDUAL PRODUCT SALES DRAWINGS FOR "B" DIMENSION.
- DOES NOT APPLY TO DUAL LEVEL HEADERS, SERIES 39528 AND 39538.
- TYP. = TYPICAL.

INITIAL RELEASE
EC NO: ETC2007-0096
DRWN: CLYORK 2006/10/02
CHKD: JMACNEIL 2006/10/04
APPR: JMACNEIL 2006/10/04

QUALITY SYMBOLS
 =0
 =0

GENERAL TOLERANCES (UNLESS SPECIFIED)	
	MM/INCH
4 PLACES	± --- ± ---
3 PLACES	± --- ± .005
2 PLACES	± 0.13 ± .01
1 PLACE	± 0.3 ± ---
ANGULAR ± 2 °	
DRAFT WHERE APPLICABLE MUST REMAIN WITHIN DIMENSIONS	

DIMENSION STYLE	
MM/IN	
DRAWN BY	DATE
C. YORK	2006/08/25
CHECKED BY	DATE
J. MACNEIL	2006/08/25
APPROVED BY	DATE
J. MACNEIL	2006/08/25
MATERIAL NO.	
--	

SCALE	DESIGN UNITS	THIRD ANGLE PROJECTION
3:1	INCH	
TITLE		
RECOMMENDED PCB LAYOUT FOR ESE TERMINAL BLOCKS		
APPROVED BY		
J. MACNEIL		
DATE		
2006/08/25		
MATERIAL NO.		
SD-39501-002		
DOCUMENT NO.		SHEET NO.
SD-39501-002		1 OF 1

10 9 8 7 6 5 4 3 2 1

F
E
D
C
B
A

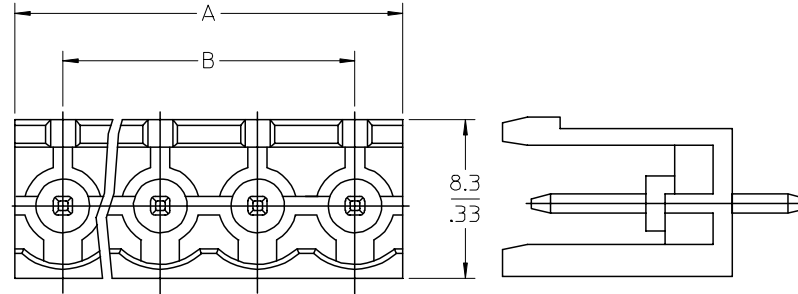
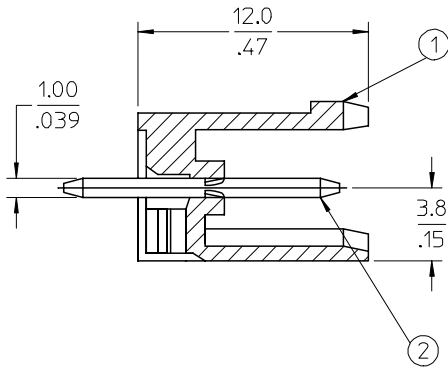
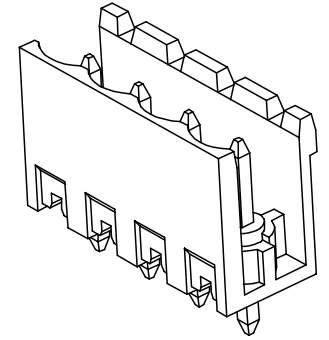
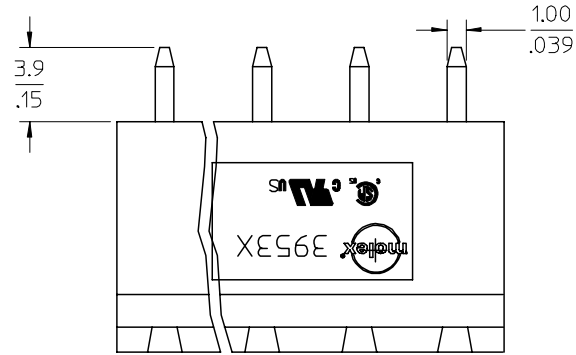

SPECIFICATIONS:

1. Material:
 - (1). Body: PA66
 - (2). Pin: Brass
2. Wire range: N/A
3. Electrical rating: 300V, 15A.
4. Wire strip length: N/A
5. Operating temperature: -40C to +105C.
6. Max torque: N/A
7. Insulation resistance: DC 500V, 500M.
8. Dielectric withstand: AC 2500V for 1 minute.
9. Breakdown voltage: 4000V.
10. A = (N x P)
11. B = (N - 1) x P
12. P (PITCH) = 5.08mm (.200").
13. N = Number of positions available 2 through 24.

ENTER DESCRIPTION EC NO: NEO2006-0310 DRWN: LROTHAUS 2006/01/09 CHKD: CYORK 2006/01/09 APPR: JPAMLIK 2006/01/10	QUALITY SYMBOLS ▽=0 ▽=0	GENERAL TOLERANCES (UNLESS SPECIFIED)		DIMENSION STYLE MM/IN		SCALE 4:1	DESIGN UNITS INCH	THIRD ANGLE PROJECTION	
			mm	INCH	DRAWN BY LROTHAUS	DATE 12/6/05	TITLE 5.08MM, EURO HEADER, VERTICAL, OPEN END		
		4 PLACES	± ---	±.0015	CHECKED BY C. YORK	DATE 01/06/06			
		3 PLACES	±0.038	±.005	APPROVED BY	DATE	MOLEX INCORPORATED		
2 PLACES	±0.13	±.01	MATERIAL NO. SEE CHART		DOCUMENT NO. SD-39531-003		SHEET NO. 1 OF 1		
1 PLACE	±0.3	± ---	DRAFT WHERE APPLICABLE MUST REMAIN WITHIN DIMENSIONS		THIS DRAWING CONTAINS INFORMATION THAT IS PROPRIETARY TO MOLEX INCORPORATED AND SHOULD NOT BE USED WITHOUT WRITTEN PERMISSION				
ANGULAR ± 2 °									

9 8 7 6 5 4 3 2 1

10 9 8 7 6 5 4 3 2 1

Description	Circuit size	Material Numbers												Dimensional Information			
		Black						Green									
		100% Tin			30 u" Gold			100% Tin			30 u" Gold			Dim. A	Dim B		
		Printing Options			Printing Options			Printing Options			Printing Options						
None	10AV	11AV	None	10AV	11AV	None	10AV	11AV	None	10AV	11AV	None	10AV	11AV	mm	inch	
5.08mm, Euro Header, Vertical, Open End	2	395310002	395310302	395310402	395310502	395310602	395310902	395315002	395315302	395315402	395315502	395315802	395315902	10.16	0.400	5.08	0.200
5.08mm, Euro Header, Vertical, Open End	3	395310003	395310303	395310403	395310503	395310603	395310903	395315003	395315303	395315403	395315503	395315803	395315903	15.24	0.600	10.16	0.400
5.08mm, Euro Header, Vertical, Open End	4	395310004	395310304	395310404	395310504	395310604	395310904	395315004	395315304	395315404	395315504	395315804	395315904	20.32	0.800	15.24	0.600
5.08mm, Euro Header, Vertical, Open End	5	395310005	395310305	395310405	395310505	395310605	395310905	395315005	395315305	395315405	395315505	395315805	395315905	25.40	1.000	20.32	0.800
5.08mm, Euro Header, Vertical, Open End	6	395310006	395310306	395310406	395310506	395310606	395310906	395315006	395315306	395315406	395315506	395315806	395315906	30.48	1.200	25.40	1.000
5.08mm, Euro Header, Vertical, Open End	7	395310007	395310307	395310407	395310507	395310607	395310907	395315007	395315307	395315407	395315507	395315807	395315907	35.56	1.400	30.48	1.200
5.08mm, Euro Header, Vertical, Open End	8	395310008	395310308	395310408	395310508	395310608	395310908	395315008	395315308	395315408	395315508	395315808	395315908	40.64	1.600	35.56	1.400
5.08mm, Euro Header, Vertical, Open End	9	395310009	395310309	395310409	395310509	395310609	395310909	395315009	395315309	395315409	395315509	395315809	395315909	45.72	1.800	40.64	1.600
5.08mm, Euro Header, Vertical, Open End	10	395310010	395310310	395310410	395310510	395310610	395310910	395315010	395315310	395315410	395315510	395315810	395315910	50.80	2.000	45.72	1.800
5.08mm, Euro Header, Vertical, Open End	11	395310011	395310311	395310411	395310511	395310611	395310911	395315011	395315311	395315411	395315511	395315811	395315911	55.88	2.200	50.80	2.000
5.08mm, Euro Header, Vertical, Open End	12	395310012	395310312	395310412	395310512	395310612	395310912	395315012	395315312	395315412	395315512	395315812	395315912	60.96	2.400	55.88	2.200
5.08mm, Euro Header, Vertical, Open End	13	395310013	395310313	395310413	395310513	395310613	395310913	395315013	395315313	395315413	395315513	395315813	395315913	66.04	2.600	60.96	2.400
5.08mm, Euro Header, Vertical, Open End	14	395310014	395310314	395310414	395310514	395310614	395310914	395315014	395315314	395315414	395315514	395315814	395315914	71.12	2.800	66.04	2.600
5.08mm, Euro Header, Vertical, Open End	15	395310015	395310315	395310415	395310515	395310615	395310915	395315015	395315315	395315415	395315515	395315815	395315915	76.20	3.000	71.12	2.800
5.08mm, Euro Header, Vertical, Open End	16	395310016	395310316	395310416	395310516	395310616	395310916	395315016	395315316	395315416	395315516	395315816	395315916	81.28	3.200	76.20	3.000
5.08mm, Euro Header, Vertical, Open End	17	395310017	395310317	395310417	395310517	395310617	395310917	395315017	395315317	395315417	395315517	395315817	395315917	86.36	3.400	81.28	3.200
5.08mm, Euro Header, Vertical, Open End	18	395310018	395310318	395310418	395310518	395310618	395310918	395315018	395315318	395315418	395315518	395315818	395315918	91.44	3.600	86.36	3.400
5.08mm, Euro Header, Vertical, Open End	19	395310019	395310319	395310419	395310519	395310619	395310919	395315019	395315319	395315419	395315519	395315819	395315919	96.52	3.800	91.44	3.600
5.08mm, Euro Header, Vertical, Open End	20	395310020	395310320	395310420	395310520	395310620	395310920	395315020	395315320	395315420	395315520	395315820	395315920	101.60	4.000	96.52	3.800
5.08mm, Euro Header, Vertical, Open End	21	395310021	395310321	395310421	395310521	395310621	395310921	395315021	395315321	395315421	395315521	395315821	395315921	106.68	4.200	101.60	4.000
5.08mm, Euro Header, Vertical, Open End	22	395310022	395310322	395310422	395310522	395310622	395310922	395315022	395315322	395315422	395315522	395315822	395315922	111.76	4.400	106.68	4.200
5.08mm, Euro Header, Vertical, Open End	23	395310023	395310323	395310423	395310523	395310623	395310923	395315023	395315323	395315423	395315523	395315823	395315923	116.84	4.600	111.76	4.400
5.08mm, Euro Header, Vertical, Open End	24	395310024	395310324	395310424	395310524	395310624	395310924	395315024	395315324	395315424	395315524	395315824	395315924	121.92	4.800	116.84	4.600

SEE SHEET 1 EC NO: NEC2006-0310 DRWNL:ROTHAUS 2006/01/09 CHKDC:YORK 2006/01/09 APPR:JPA:ML CK 2006/01/10	QUALITY SYMBOLS ▽=0 ▽=0	GENERAL TOLERANCES (UNLESS SPECIFIED)		DIMENSION STYLE		SCALE	DESIGN UNITS	THIRD ANGLE PROJECTION	
				MM/IN		4:1	INCH		
				DRAWN BY DATE		TITLE			
				CHECKED BY DATE		MATERIAL NO.		DOCUMENT NO.	
		APPROVED BY DATE		SEE CHART		SD-39531-003			
		ANGULAR ± 2 °		DRAFT WHERE APPLICABLE MUST REMAIN WITHIN DIMENSIONS		SHEET NO. 2 OF 2			
				THIS DRAWING CONTAINS INFORMATION THAT IS PROPRIETARY TO MOLEX INCORPORATED AND SHOULD NOT BE USED WITHOUT WRITTEN PERMISSION					

9 8 7 6 5 4 3 2 1