

R13-502

Screw Type

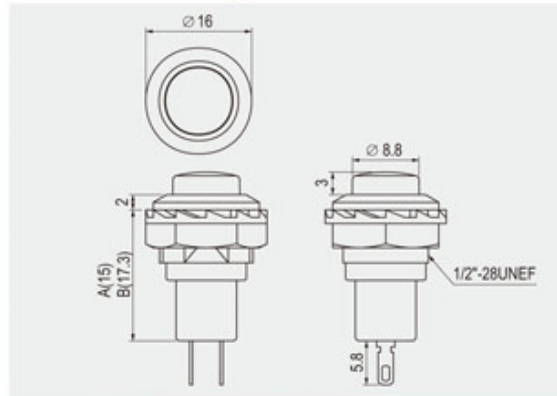

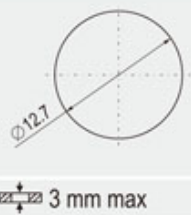





Rating	3A 125V AC 1.5A 250V AC
Contact resistance	50mΩ Max
Insulation resistance	DC 500V 100MΩ Min
Dielectric strength	AC 1000V 1 minute
Cut-out	

FEATURES

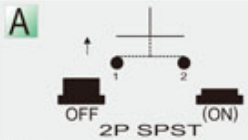
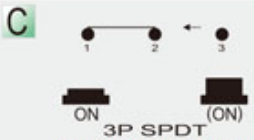
- * MATERIAL: Actuator and Frame are nylon (UL flame: 94V-2). Terminals are silver plated brass. Base is PBT.
- * M types are metal frames, nickel plated brass.
- * Mounted by nut.

R13-502

BODY	FUNCTION		TERMINAL
 Plastic Body 	A 	C 	0 5  SO
 Metal Body 	B 	(Only for R13-502MC) * () = momentary	

