

Cell Type CR17335SE Specifications

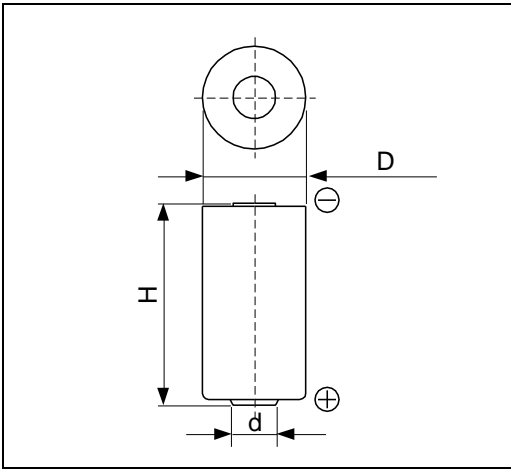

Nominal Voltage (V)		3
Nominal Capacity (mAh) *1		1800
Standard Discharge Current (mA)		0.5
Operating Temperature Range (°C) *2		-40 ~ +85
Max. Dimensions (mm)	Diameter (D)	17.0
	Height (H)	33.5
Approx. Weight (g)		17

*1 Nominal capacity is determined at an end voltage of 2.0V when the battery is allowed to discharge at a standard current level at +23°C.

*2 Consult FDK when using batteries at temperatures exceeding the -20°C to +60°C range.

Typical Characteristics

Discharge Characteristics of CR17335SE

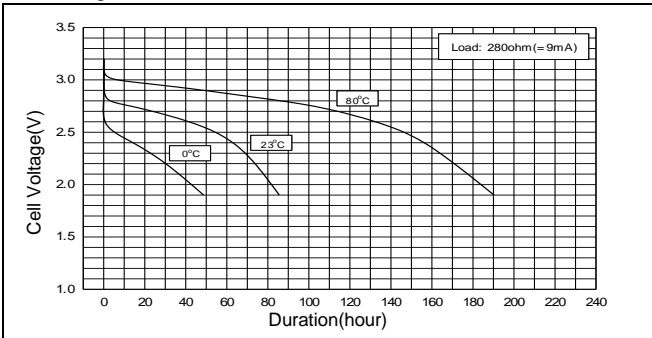

Discharge Characteristics of CR17335SE

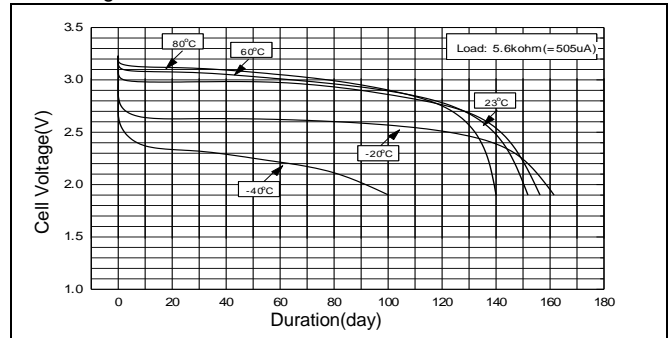

Discharge Characteristics of CR17335SE

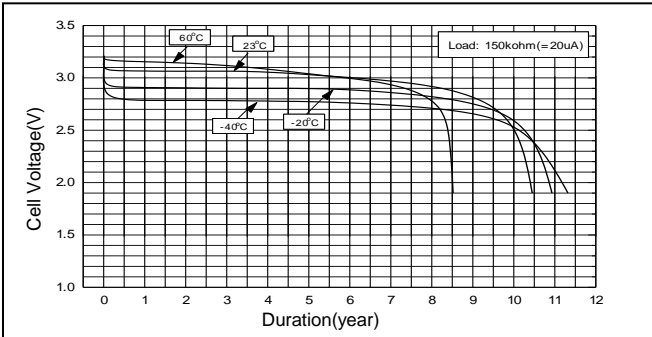

Discharge Load vs. Capacity of CR17335SE

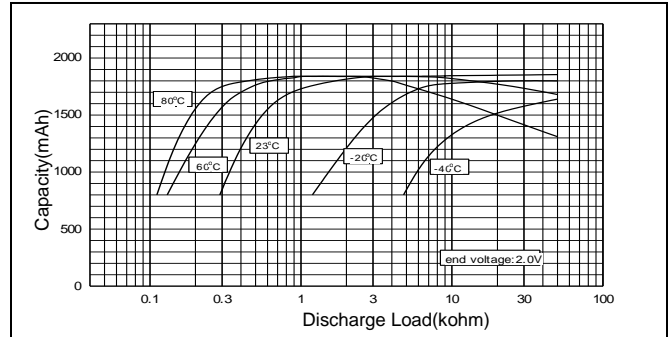

Discharge Load vs. Operating Voltage of CR17335SE

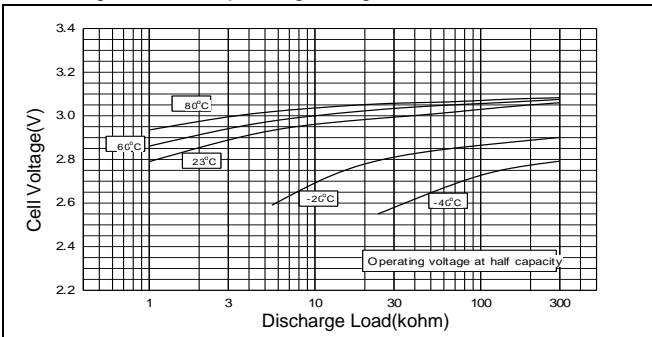

Discharge Characteristics of CR17335SE

