

## Resonant Mode Combi IGBT®

The Thunderbolt HS™ IGBT used in this resonant mode combi is based on thin wafer non-punch through (NPT) technology similar to the Thunderbolt® series, but trades higher  $V_{CE(ON)}$  for significantly lower turn-on energy  $E_{off}$ . The low switching losses enable operation at switching frequencies over 100kHz, approaching power MOSFET performance but lower cost.

An extremely tight parameter distribution combined with a positive  $V_{CE(ON)}$  temperature coefficient make it easy to parallel Thunderbolts HS™ IGBT's. Controlled slew rates result in very good noise and oscillation immunity and low EMI. The short circuit duration rating of 10 $\mu$ s make these IGBT's suitable for motor drive and inverter applications. Reliability is further enhanced by avalanche energy ruggedness. Combi versions are packaged with a high speed, soft recovery DL series diode.

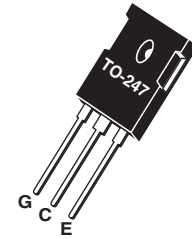

Single die IGBT with separate DL

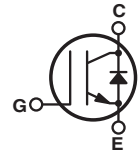

### Features

- Fast Switching with low EMI
- Very Low  $E_{OFF}$  for Maximum Efficiency
- Short circuit rated
- Low Gate Charge
- RoHS Compliant
- Tight parameter distribution
- Easy paralleling
- Low Forward Diode Voltage (VF)
- Ultrasoft Recovery Diode

### Typical Applications

- ZVS Phase Shifted Bridge
- Resonant Mode Switching
- Phase Shifted Bridge
- Welding
- Induction heating
- High Frequency SMPS

### Absolute Maximum Ratings

Symbol	Parameter	Rating	Unit
$I_{C1}$	Continuous Collector Current $T_C = @ 25^\circ C$	54	A
$I_{C2}$	Continuous Collector Current $T_C = @ 100^\circ C$	30	
$I_{CM}$	Pulsed Collector Current <sup>①</sup>	113	
$V_{GE}$	Gate-Emitter Voltage	$\pm 30V$	V
SSOA	Switching Safe Operating Area	113	
$t_{SC}$	Short Circuit Withstand Time <sup>③</sup>	10	$\mu s$

### Thermal and Mechanical Characteristics

Symbol	Parameter	Min	Typ	Max	Unit
$P_D$	Total Power Dissipation $T_C = @ 25^\circ C$	-	-	250	W
$R_{\theta JC}$	Junction to Case Thermal Resistance	IGBT	-	0.50	$^\circ C/W$
		Diode		1.0	
$R_{\theta CS}$	Case to Sink Thermal Resistance, Flat Greased Surface	-	0.11	-	
$T_J, T_{STG}$	Operating and Storage Junction Temperature Range	-55	-	150	$^\circ C$
$T_L$	Soldering Temperature for 10 Seconds (1.6mm from case)	-	-	300	
$W_T$	Package Weight	-	0.22	-	oz
		-	5.9	-	g

**CAUTION:** These Devices are Sensitive to Electrostatic Discharge. Proper Handling Procedures Should be Followed.

**Static Characteristics**
 **$T_J = 25^\circ\text{C}$  unless otherwise specified**
**APT30GS60BRDL(G)**

Symbol	Parameter	Test Conditions	Min	Typ	Max	Unit	
$V_{BR(CES)}$	Collector-Emitter Breakdown Voltage	$V_{GE} = 0V, I_C = 250\mu A$	600	-	-	V	
$\Delta V_{BR(CES)}/\Delta T_J$	Breakdown Voltage Temperature Coeff	Reference to $25^\circ\text{C}, I_C = 250\mu A$	-	0.60	-	V/ $^\circ\text{C}$	
$V_{CE(ON)}$	Collector-Emitter On Voltage <sup>④</sup>	$V_{GE} = 15V$ $I_C = 30A$	$T_J = 25^\circ\text{C}$	-	2.8	3.15	V
			$T_J = 125^\circ\text{C}$	-	3.25	-	
$V_{GE(th)}$	Gate-Emitter Threshold Voltage	$V_{GE} = V_{CE}, I_C = 1mA$	3	4	5	mV/ $^\circ\text{C}$	
$\Delta V_{GE(th)}/\Delta T_J$	Threshold Voltage Temp Coeff		-	6.7	-		
$I_{CES}$	Zero Gate Voltage Collector Current	$V_{CE} = 600V,$ $V_{GE} = 0V$	$T_J = 25^\circ\text{C}$	-	-	50	$\mu A$
			$T_J = 125^\circ\text{C}$	-	-	1000	
$I_{GES}$	Gate-Emitter Leakage Current	$V_{GE} = \pm 20V$	-	-	$\pm 100$	nA	

**Dynamic Characteristics**
 **$T_J = 25^\circ\text{C}$  unless otherwise specified**

Symbol	Parameter	Test Conditions	Min	Typ	Max	Unit
$g_{fs}$	Forward Transconductance	$V_{CE} = 50V, I_C = 30A$	-	18	-	S
$C_{ies}$	Input Capacitance	$V_{GE} = 0V, V_{CE} = 25V$ $f = 1MHz$	-	1600	-	pF
$C_{oes}$	Output Capacitance		-	140	-	
$C_{res}$	Reverse Transfer Capacitance		-	90	-	
$C_{o(cr)}$	Reverse Transfer Capacitance Charge Related <sup>⑤</sup>	$V_{GE} = 0V$ $V_{CE} = 0$ to $400V$	-	130	-	pF
$C_{o(er)}$	Reverse Transfer Capacitance Current Related <sup>⑥</sup>		-	95	-	
$Q_g$	Total Gate Charge	$V_{GE} = 0$ to $15V$ $I_C = 30A, V_{CE} = 300V$	-	145	-	nC
$Q_{ge}$	Gate-Emitter Charge		-	12	-	
$G_{gc}$	Gate-Collector Charge		-	65	-	
$t_{d(on)}$	Turn-On Delay Time	Inductive Switching IGBT and Diode:  $T_J = 25^\circ\text{C}, V_{CC} = 400V,$ $I_C = 30A$ $R_G = 9.1\Omega$ <sup>⑦</sup> , $V_{GG} = 15V$	-	16	-	ns
$t_r$	Rise Time		-	29	-	
$t_{d(off)}$	Turn-Off Delay Time		-	360	-	
$t_f$	Fall Time		-	27	-	
$E_{on1}$	Turn-On Switching Energy <sup>⑧</sup>	Inductive Switching IGBT and Diode:  $T_J = 125^\circ\text{C}, V_{CC} = 400V,$ $I_C = 30A$ $R_G = 9.1\Omega$ <sup>⑦</sup> , $V_{GG} = 15V$	-	TBD	-	$\mu J$
$E_{on2}$	Turn-On Switching Energy <sup>⑨</sup>		-	800	-	
$E_{off}$	Turn-Off Switching Energy <sup>⑩</sup>		-	570	-	
$t_{d(on)}$	Turn-On Delay Time	Inductive Switching IGBT and Diode:  $T_J = 125^\circ\text{C}, V_{CC} = 400V,$ $I_C = 30A$ $R_G = 9.1\Omega$ <sup>⑦</sup> , $V_{GG} = 15V$	-	16	-	ns
$t_r$	Rise Time		-	29	-	
$t_{d(off)}$	Turn-Off Delay Time		-	390	-	
$t_f$	Fall Time		-	22	-	
$E_{on1}$	Turn-On Switching Energy <sup>⑧</sup>	Inductive Switching IGBT and Diode:  $T_J = 125^\circ\text{C}, V_{CC} = 400V,$ $I_C = 30A$ $R_G = 9.1\Omega$ <sup>⑦</sup> , $V_{GG} = 15V$	-	TBD	-	$\mu J$
$E_{on2}$	Turn-On Switching Energy <sup>⑨</sup>		-	1185	-	
$E_{off}$	Turn-Off Switching Energy <sup>⑩</sup>		-	695	-	

**TYPICAL PERFORMANCE CURVES**

**APT30GS60BRDL(G)**

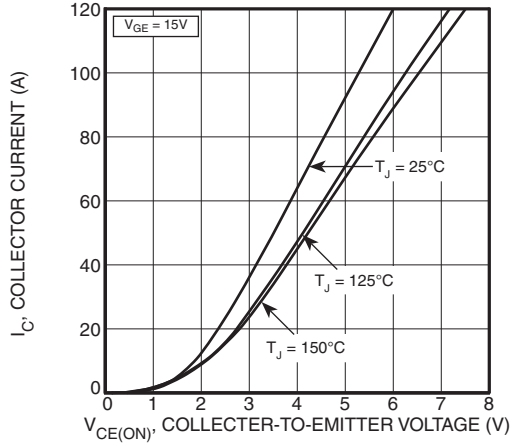

**FIGURE 1, Output Characteristics**

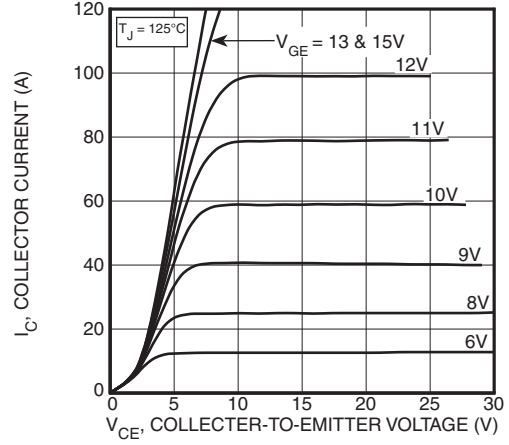

**FIGURE 2, Output Characteristics**

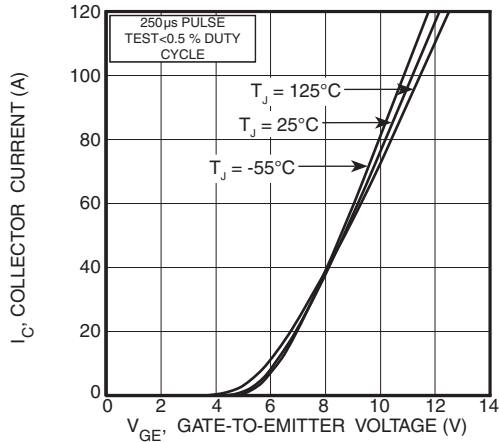

**FIGURE 3, Transfer Characteristics**

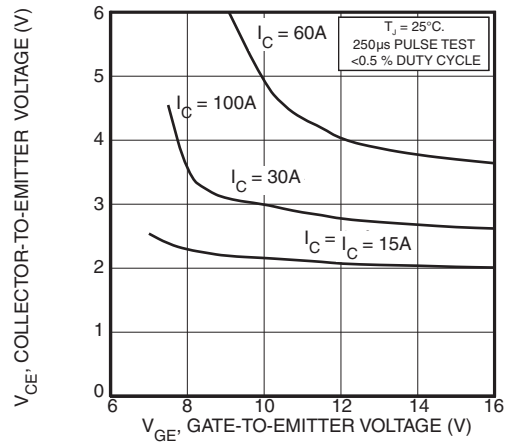

**FIGURE 4, On State Voltage vs Gate-to-Emitter Voltage**

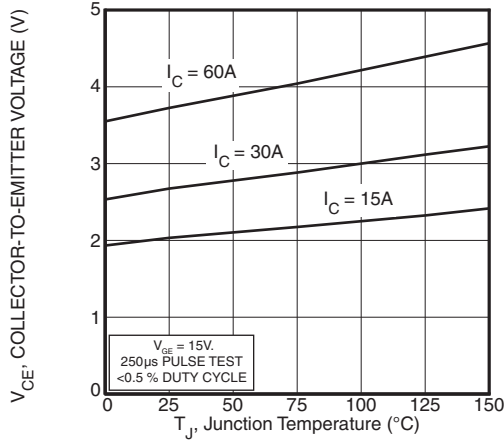

**FIGURE 5, On State Voltage vs Junction Temperature**

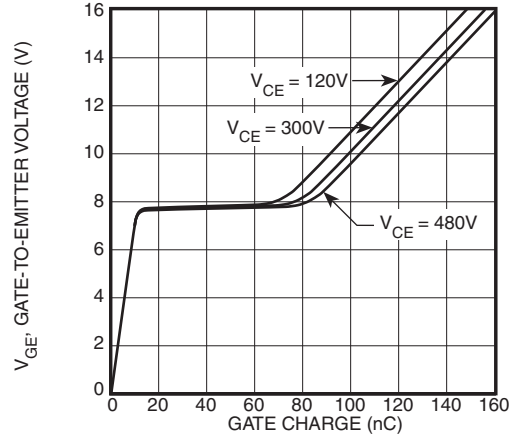

**FIGURE 6, Gate Charge**

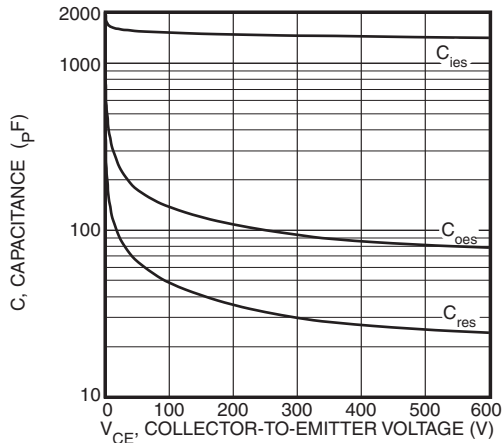

**FIGURE 7, Capacitance vs Collector-To-Emitter Voltage**

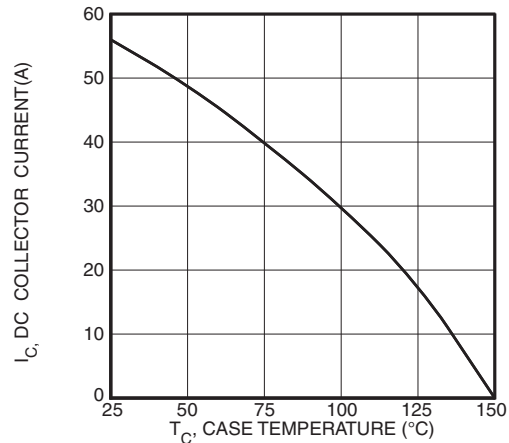

**FIGURE 8, DC Collector Current vs Case Temperature**

**TYPICAL PERFORMANCE CURVES**

**APT30GS60BRDL(G)**

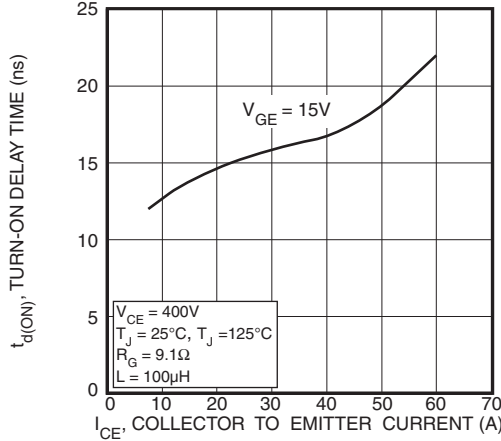

**FIGURE 9, Turn-On Delay Time vs Collector Current**

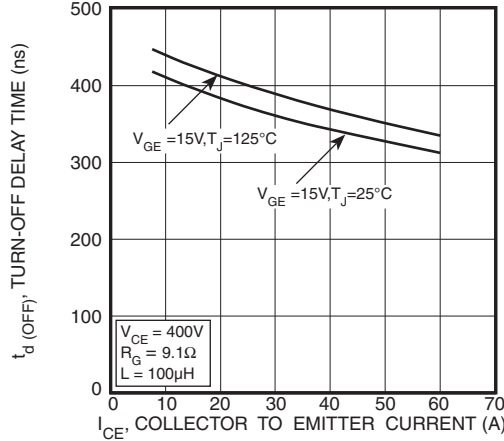

**FIGURE 10, Turn-Off Delay Time vs Collector Current**

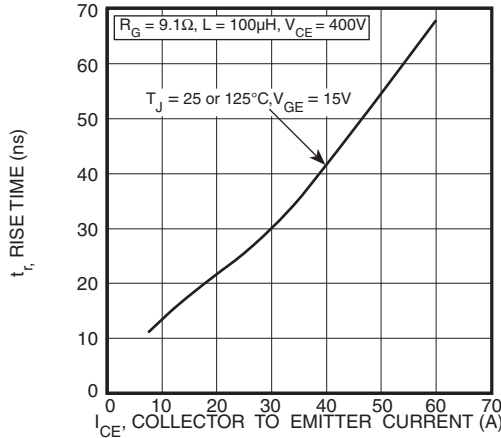

**FIGURE 11, Current Rise Time vs Collector Current**

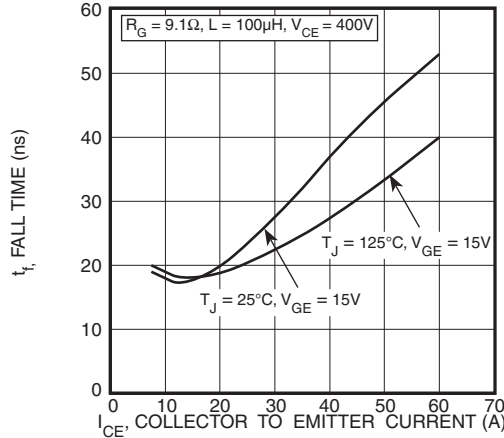

**FIGURE 12, Current Fall Time vs Collector Current**

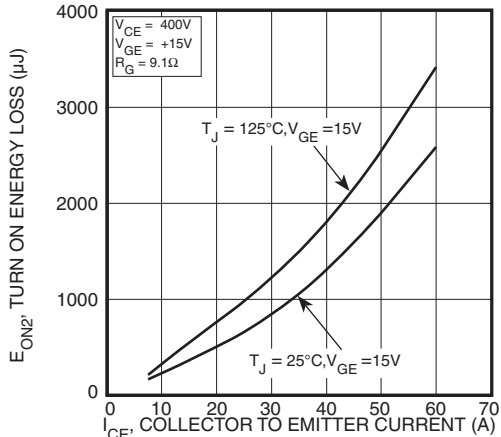

**FIGURE 13, Turn-On Energy Loss vs Collector Current**

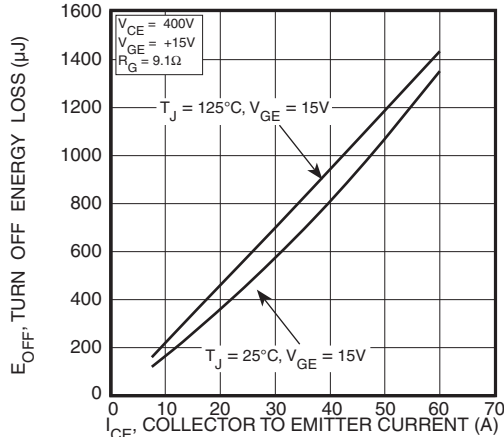

**FIGURE 14, Turn Off Energy Loss vs Collector Current**

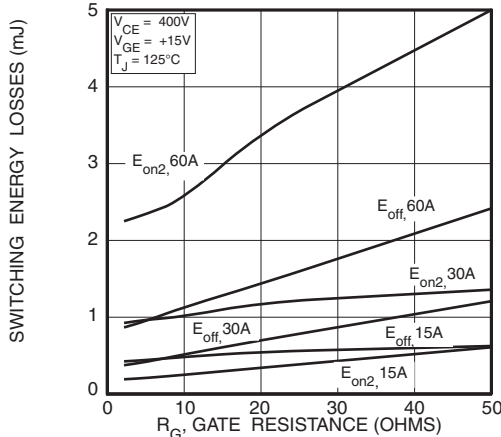

**FIGURE 15, Switching Energy Losses vs. Gate Resistance**

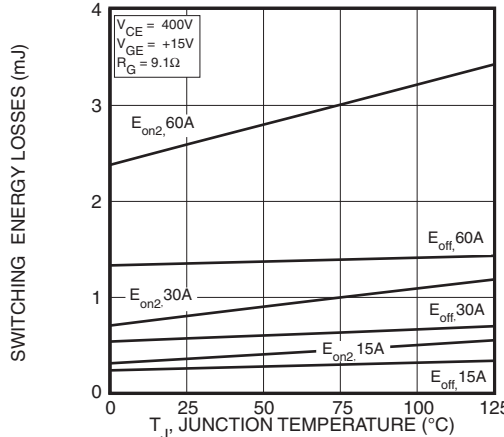

**FIGURE 16, Switching Energy Losses vs Junction Temperature**

TYPICAL PERFORMANCE CURVES

APT30GS60BRDL(G)

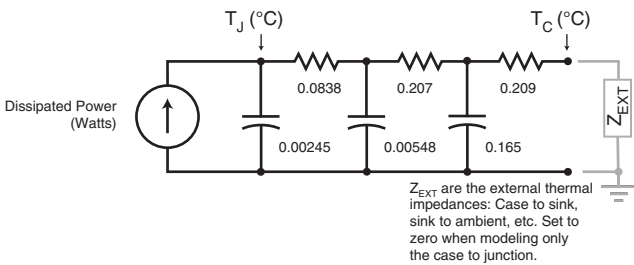
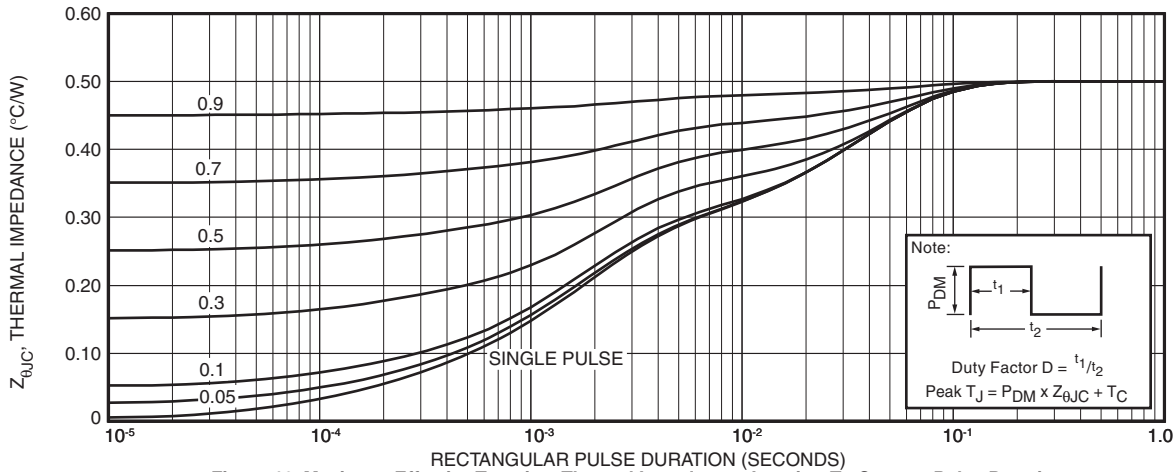
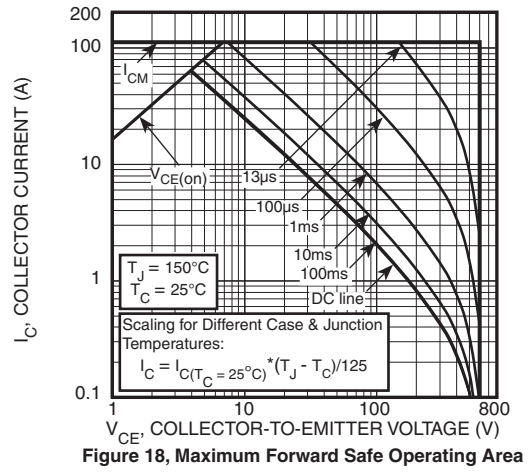
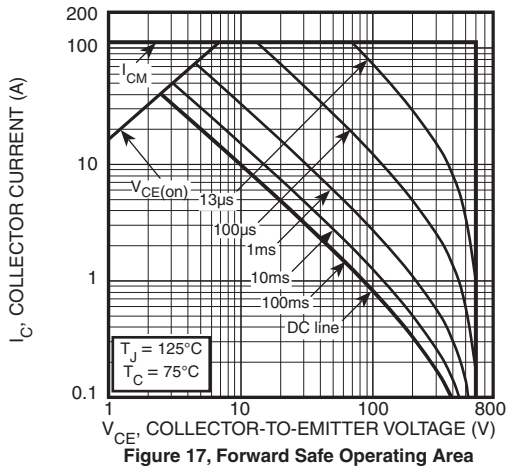

Figure 20, Transient Thermal Impedance Model

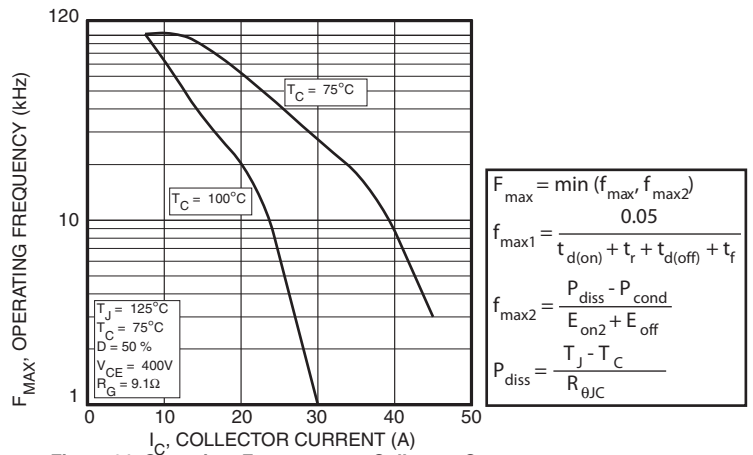

Figure 21, Operating Frequency vs Collector Current

$$F_{max} = \min(f_{max1}, f_{max2})$$

$$f_{max1} = \frac{0.05}{t_{d(on)} + t_r + t_{d(off)} + t_f}$$

$$f_{max2} = \frac{P_{diss} - P_{cond}}{E_{on2} + E_{off}}$$

$$P_{diss} = \frac{T_J - T_C}{R_{\theta JC}}$$

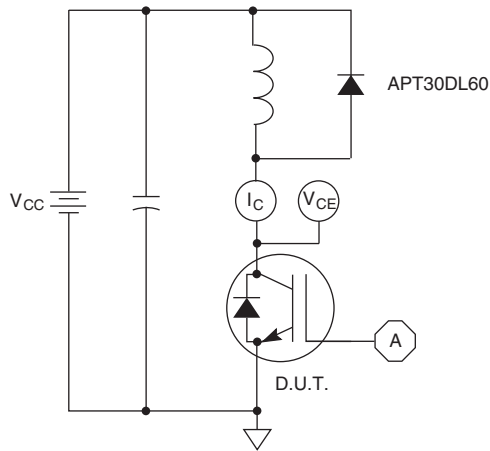

Figure 22, Inductive Switching Test Circuit

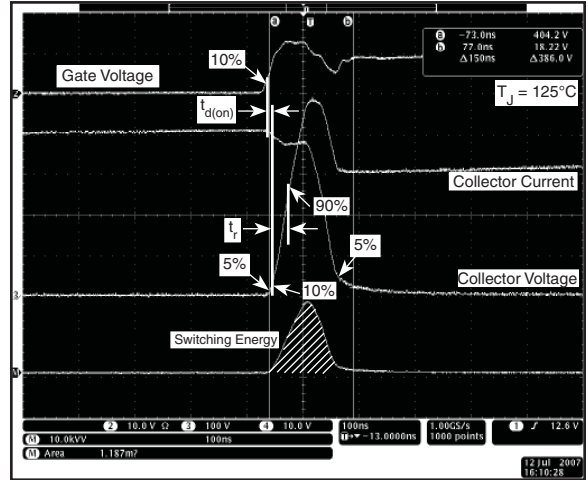

Figure 23, Turn-on Switching Waveforms and Definitions

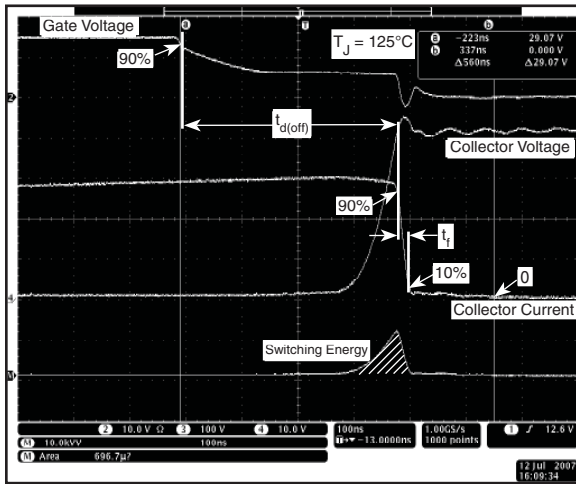

Figure 24, Turn-off Switching Waveforms and Definitions

FOOT NOTE:

- ① Repetitive Rating: Pulse width and case temperature limited by maximum junction temperature.
- ③ Short circuit time:  $V_{GE} = 15V, V_{CC} \leq 600V, T_J \leq 150^\circ C$
- ④ Pulse test: Pulse width  $< 380\mu s$ , duty cycle  $< 2\%$
- ⑤  $C_{o(cr)}$  is defined as a fixed capacitance with the same stored charge as  $C_{oes}$  with  $V_{CE} = 67\%$  of  $V_{(BR)CES}$ .
- ⑥  $C_{o(er)}$  is defined as a fixed capacitance with the same stored energy as  $C_{oes}$  with  $V_{CE} = 67\%$  of  $V_{(BR)CES}$ . To calculate  $C_{o(er)}$  for any value of  $V_{CE}$  less than  $V_{(BR)CES}$ , use this equation:  $C_{o(er)} = -1.40E-7/V_{DS}^2 + 1.47E-8/V_{DS} + 5.95E-11$ .
- ⑦  $R_G$  is external gate resistance, not including internal gate resistance or gate driver impedance (MIC4452).
- ⑧  $E_{on1}$  is the inductive turn-on energy of the IGBT only, without the effect of a commutating diode reverse recovery current adding to the IGBT turn-on switching loss. It is measured by clamping the inductance with a Silicon Carbide Schottky diode.
- ⑨  $E_{on2}$  is the inductive turn-on energy that includes a commutating diode reverse recovery current in the IGBT turn-on energy.
- ⑩  $E_{off}$  is the clamped inductive turn-off energy measured in accordance with JEDEC standard JESD24-1.

Microsemi reserves the right to change, without notice, the specifications and information contained herein.

# ULTRAFAST SOFT RECOVERY ANTI-PARALLEL DIODE

**MAXIMUM RATINGS**

All Ratings:  $T_C = 25^\circ\text{C}$  unless otherwise specified.

Symbol	Characteristic / Test Conditions	APT30GS60BRDL(G)		UNIT
$I_F(\text{AV})$	Maximum Average Forward Current ( $T_C = 126^\circ\text{C}$ , Duty Cycle = 0.5)	30		Amps
$I_F(\text{RMS})$	RMS Forward Current (Square wave, 50% duty)	51		
$I_{\text{FSM}}$	Non-Repetitive Forward Surge Current ( $T_J = 45^\circ\text{C}$ , 8.3ms)	320		

**STATIC ELECTRICAL CHARACTERISTICS**

Symbol	Characteristic / Test Conditions	MIN	TYP	MAX	UNIT	
$V_F$	Forward Voltage		$I_F = 30\text{A}$	1.25	1.6	Volts
			$I_F = 60\text{A}$	2.0		
			$I_F = 30\text{A}, T_J = 125^\circ\text{C}$	1.25		

**DYNAMIC CHARACTERISTICS**

Symbol	Characteristic	Test Conditions	MIN	TYP	MAX	UNIT
$t_{\text{rr}}$	Reverse Recovery Time	$I_F = 1\text{A}, di_F/dt = -100\text{A}/\mu\text{s}, V_R = 30\text{V}, T_J = 25^\circ\text{C}$	-	64		ns
$t_{\text{rr}}$	Reverse Recovery Time	$I_F = 30\text{A}, di_F/dt = -200\text{A}/\mu\text{s}, V_R = 400\text{V}, T_C = 25^\circ\text{C}$	-	317		
$Q_{\text{rr}}$	Reverse Recovery Charge		-	962		nC
$I_{\text{RRM}}$	Maximum Reverse Recovery Current		-	7	-	Amps
$t_{\text{rr}}$	Reverse Recovery Time	$I_F = 30\text{A}, di_F/dt = -200\text{A}/\mu\text{s}, V_R = 400\text{V}, T_C = 125^\circ\text{C}$	-	561		ns
$Q_{\text{rr}}$	Reverse Recovery Charge		-	2244		nC
$I_{\text{RRM}}$	Maximum Reverse Recovery Current		-	9	-	Amps
$t_{\text{rr}}$	Reverse Recovery Time	$I_F = 30\text{A}, di_F/dt = -1000\text{A}/\mu\text{s}, V_R = 400\text{V}, T_C = 125^\circ\text{C}$	-	264		ns
$Q_{\text{rr}}$	Reverse Recovery Charge		-	3191		nC
$I_{\text{RRM}}$	Maximum Reverse Recovery Current		-	26		Amps

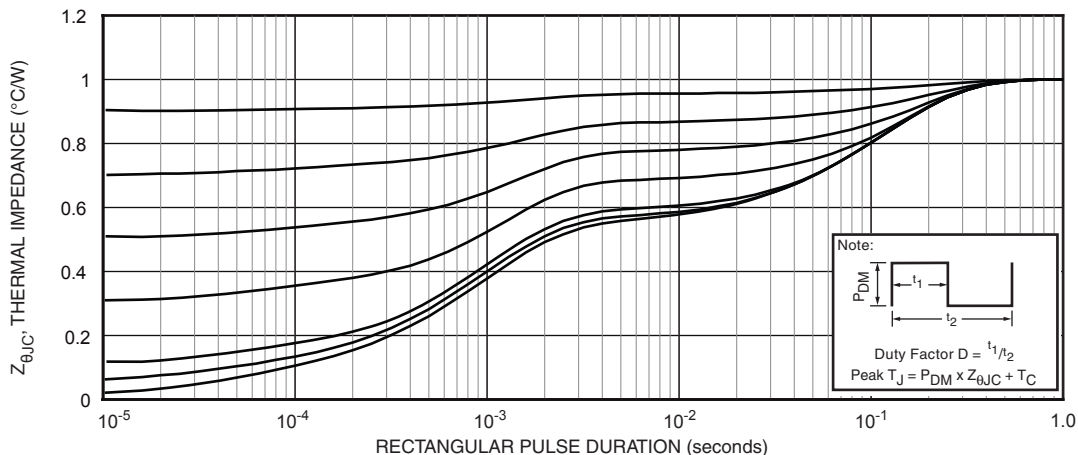

FIGURE 1a. MAXIMUM EFFECTIVE TRANSIENT THERMAL IMPEDANCE, JUNCTION-TO-CASE vs. PULSE DURATION

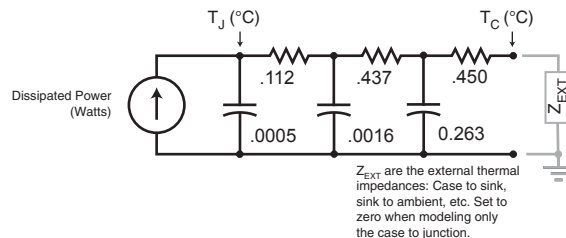
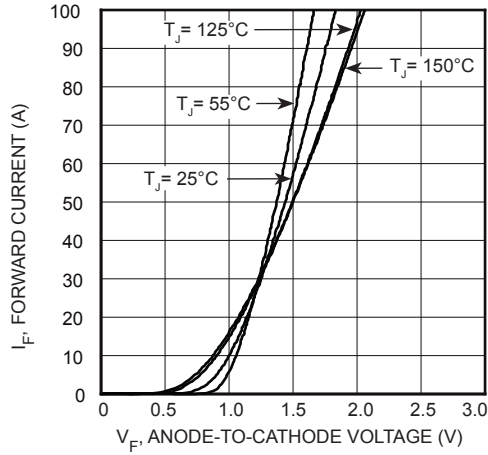

FIGURE 1b, TRANSIENT THERMAL IMPEDANCE MODEL

**TYPICAL PERFORMANCE CURVES**

**APT30GS60BRDL(G)**



**FIGURE 2, Forward Current vs. Forward Voltage**

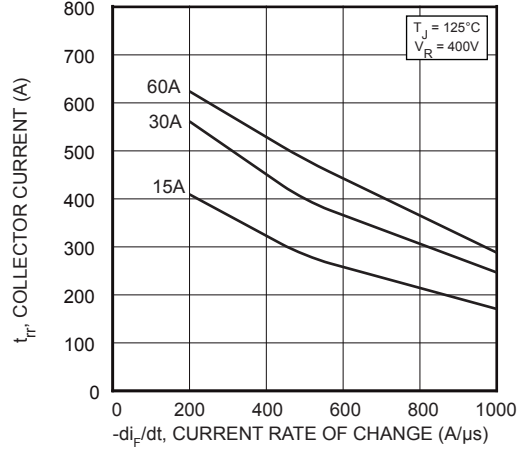

**FIGURE 3, Reverse Recovery Time vs. Current Rate of Change**

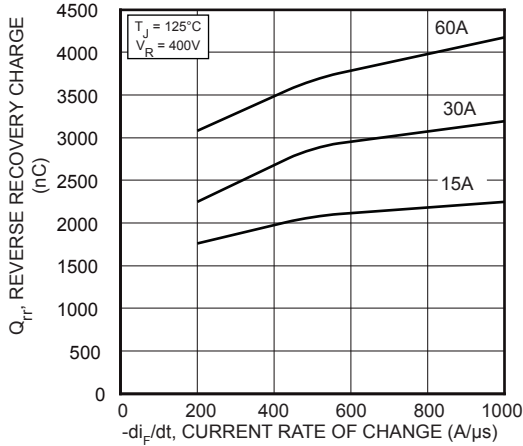

**FIGURE 4, Reverse Recovery Charge vs. Current Rate of Change**

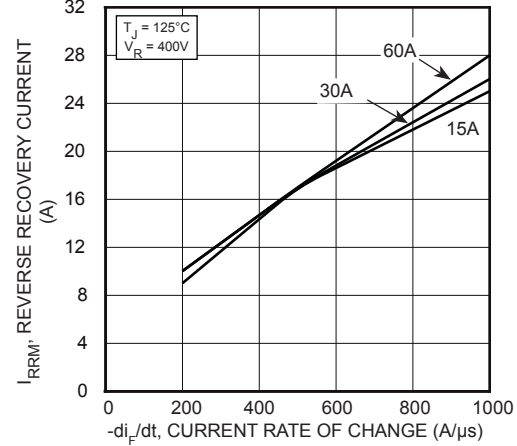

**FIGURE 5, Reverse Recovery Current vs. Current Rate of Change**

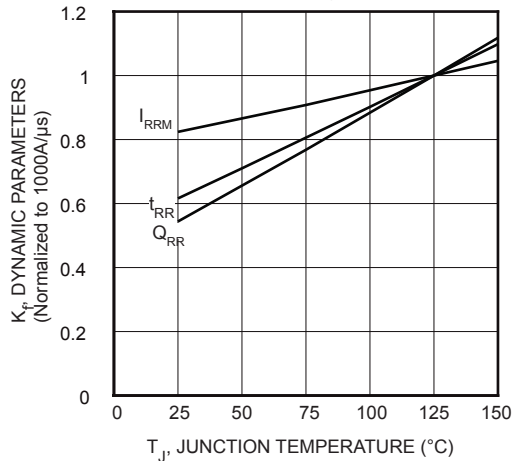

**FIGURE 6, Dynamic Parameters vs. Junction Temperature**

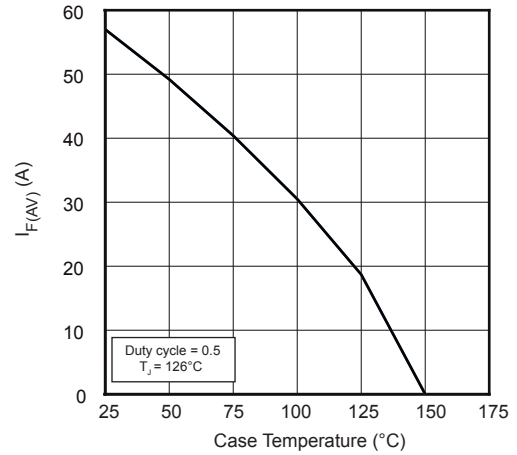

**FIGURE 7, Maximum Average Forward Current vs. Case Temperature**

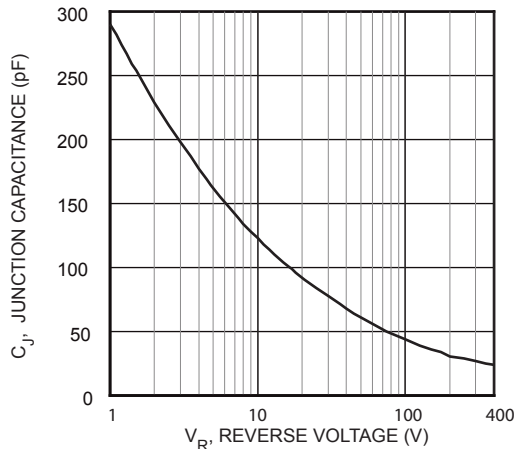

**FIGURE 8, Junction Capacitance vs. Reverse Voltage**

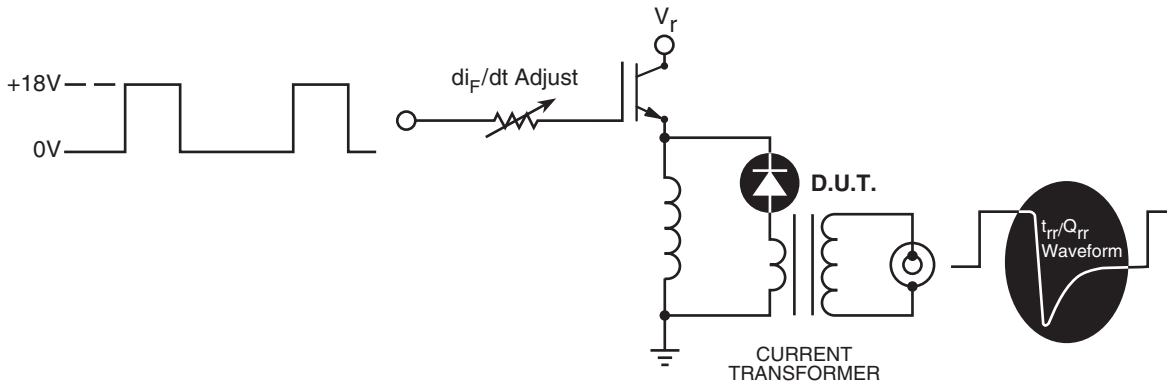

Figure 9. Diode Test Circuit

- 1  $I_F$  - Forward Conduction Current
- 2  $di_F/dt$  - Rate of Diode Current Change Through Zero Crossing.
- 3  $I_{RRM}$  - Maximum Reverse Recovery Current.
- 4  $t_{rr}$  - Reverse Recovery Time, measured from zero crossing where diode current goes from positive to negative, to the point at which the straight line through  $I_{RRM}$  and  $0.25 \cdot I_{RRM}$  passes through zero.
- 5  $Q_{rr}$  - Area Under the Curve Defined by  $I_{RRM}$  and  $t_{rr}$ .
- 6  $di_M/dt$  - Maximum Rate of Current Increase During the Trailing Portion of  $t_{rr}$ .

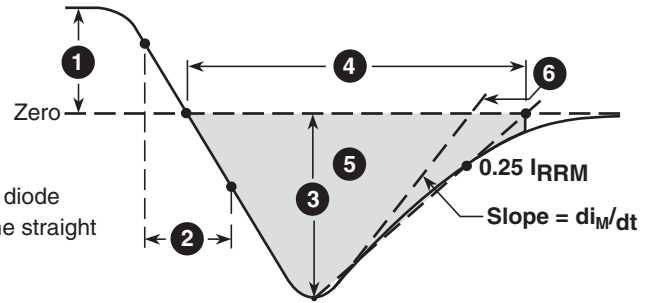
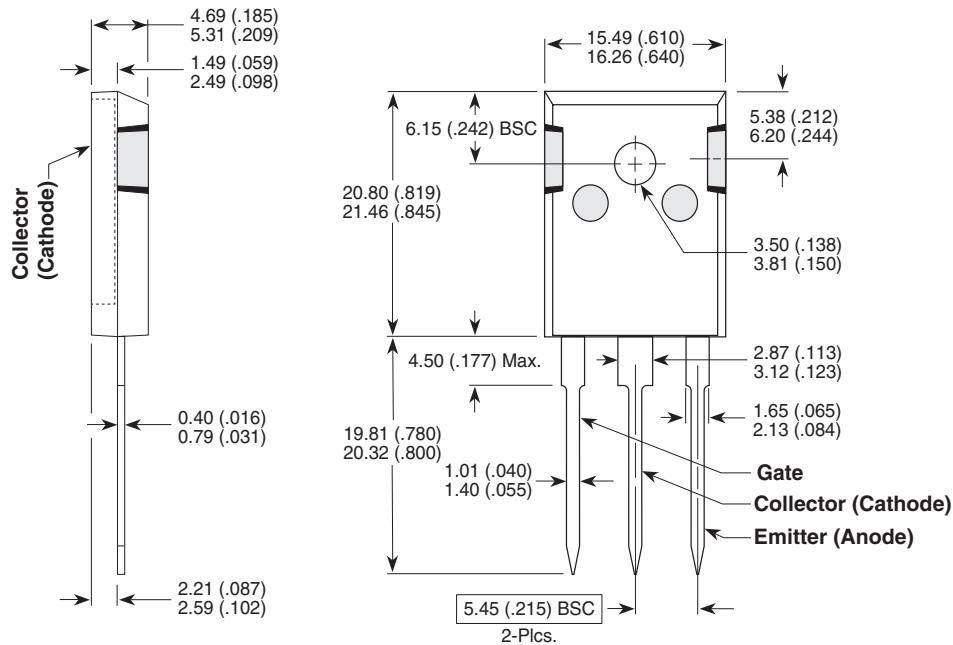

Figure 10, Diode Reverse Recovery Waveform and Definitions

### TO-247 (B) Package Outline



Dimensions in Millimeters and (Inches)