

Features

- Constant Power mode output
- Metal housing design with functional Ground
- Built-in active PFC function
- Class 2 power unit
- No load / Standby power consumption <0.5W
- IP67 rating for indoor or outdoor installations
- Function options: output adjustable via potentiometer
3 in 1 dimming function (Dim to off and Isolation design)
- Typical lifetime>50000 hours
- 5 years warranty

Applications

- LED street lighting
- LED architectural lighting
- LED bay lighting
- LED floodlighting
- Type “HL” for use in Class I, Division 2 hazardous (Classified) location.

Description

XLG-25 series is a 25W AC/DC LED driver featuring the constant power mode output. XLG-25 operates from 90~305VAC. Thanks to the high efficiency up to 88%, The entire series is able to operate between -40°C ~85°C wide case temperature range with air convection. The design of metal housing and Ip67 ingress protection level allows this series to fit both indoor and outdoor applications. XLG-25 is equipped with various function options, such as dimming methodologies, so as to provide the optimal design flexibility for LED lighting system. XLG-25 series comply with the latest version of IEC61347/GB7000.1 -2015 and UL8750 international safety regulations. The output and dimming circuit are also completely in accordance with the new regulations with isolation to ensure the safety of both user and luminaire system during installation.

Model Encoding

XLG - 25 I - A

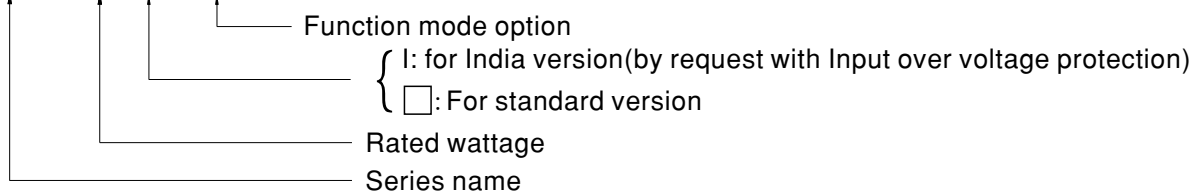

Type	IP Level	Function	Note
A	IP67	Io adjustable through built in potentiometer.	In Stock
AB	IP67	Io adjustable through built in potentiometer 3 in 1 dimming function (0~10Vdc, 10V PWM signal and resistance)	In Stock

SPECIFICATION

MODEL		XLG-25□-□		
OUTPUT	RATED CURRENT	700mA		
	CONSTANT CURRENT REGION <small>Note.2</small>	22 ~54V		
	RATED POWER	90VAC ~ 305VAC		
		25W		
	CURRENT RIPPLE	5.0% max. @rated current		
	OPEN CIRCUIT VOLTAGE (max.)	57V		
	CURRENT ADJ. RANGE	0.25 ~ 1.05A		
	SETUP, RISE TIME <small>Note.3</small>	500ms, 100ms/115VAC, 230VAC		
INPUT	VOLTAGE RANGE <small>Note.4</small>	90 ~ 305VAC 127 ~ 431VDC (Please refer to "STATIC CHARACTERISTIC" section)		
	FREQUENCY RANGE	47 ~ 63Hz		
	POWER FACTOR	PF ≥ 0.97/115VAC, PF ≥ 0.95/230VAC, PF ≥ 0.92/277VAC@full load (Please refer to "POWER FACTOR (PF) CHARACTERISTIC" section)		
	TOTAL HARMONIC DISTORTION	THD < 10% (@load ≥ 50%/115VAC, 230VAC; @load ≥ 75%/277VAC) (Please refer to "TOTAL HARMONIC DISTORTION(THD)" section)		
	EFFICIENCY (Typ.) <small>Note.10</small>	88%		
	AC CURRENT	0.29A / 115VAC 0.15A / 230VAC 0.13A/277VAC		
	INRUSH CURRENT(Typ.)	COLD START 50A(twidth=350μs measured at 50% Ipeak) at 230VAC; Per NEMA 410		
	MAX. No. of PSUs on 16A CIRCUIT BREAKER	5 units (circuit breaker of type B) / 8 units (circuit breaker of type C) at 230VAC		
	LEAKAGE CURRENT	<0.75mA / 277VAC		
	NO LOAD / STANDBY POWER CONSUMPTION	No load power consumption <0.5W for A, <0.75W for I series Standby power consumption <0.5W for AB-Type(Dimming OFF)		
PROTECTION	OVER POWER	110-150% Over Power Protection, recovers automatically after fault condition is removed		
	OVER CURRENT	Constant current limiting, recovers automatically after fault condition is removed		
	SHORT CIRCUIT	Constant current limiting, recovers automatically after fault condition is removed		
	OVER TEMPERATURE	Hiccup mode, recovers automatically after fault condition is removed		
	INPUT OVER VOLTAGE <small>Note.8</small>	320 ~ 370VAC (Shut down output voltage when the input voltage exceeds protection voltage, recovers automatically after fault condition is removed) Can survive input voltage stress of 440Vac for 48 hours @ tc 75°C max		
ENVIRONMENT	WORKING TEMP.	Tcase=-40 ~ +85°C (Please refer to " OUTPUT LOAD vs TEMPERATURE" section)		
	MAX. CASE TEMP.	Tcase=+85°C		
	WORKING HUMIDITY	20 ~ 95% RH non-condensing		
	STORAGE TEMP.	-40 ~ +80°C		
	TEMP. COEFFICIENT	±0.03%/°C (0 ~ 60°C)		
	VIBRATION	10 ~ 500Hz, 5G 12min./1cycle, period for 72min. each along X, Y, Z axes		
SAFETY & EMC	SAFETY STANDARDS <small>Note.8</small>	UL8750(type"HL"), CSA C22.2 No. 250.13-12; ENEC AS/NZS IEC EN61347-1, AS/NZS EN61347-2-13 independent, EN62384;IP67; GB19510.1, GB19510.14, EAC TP TC 004, J61347-1(H29), J61347-2-13(H29), KC61347-1, KC61347-2-13, IS15885(Part2/Sec13)(for XLG-25I type only); NOM-058-SCFI-2017 approved		
	WITHSTAND VOLTAGE	I/P-O/P:3.75KVAC I/P-FG:2.0KVAC O/P-FG:1.5KVAC		
	ISOLATION RESISTANCE	I/P-O/P, I/P-FG, O/P-FG:100M Ohms / 500VDC / 25°C / 70% RH		
	EMC EMISSION	Parameter	Standard	Test Level/Note
		Conducted	EN55015(CISPR15) ,GB/T17743	-----
		Radiated	EN55015(CISPR15) ,GB/T17743	-----
		Harmonic Current	EN61000-3-2 ,GB/T17625.1	Class C @load ≥ 50%
	EMC IMMUNITY	Voltage Flicker	EN61000-3-3	-----
		Parameter	Standard	Test Level/Note
		ESD	EN61000-4-2	Level 3, 8KV air ; Level 2, 4KV contact
Radiated		EN61000-4-3	Level 3	
EFT/Burst		EN61000-4-4	Level 3	
Surge		EN61000-4-5	4KV/Line-Line 6KV/Line-Earth	
Conducted		EN61000-4-6	Level 3	
Magnetic Field	EN61000-4-8	Level 4		
Voltage Dips and Interruptions	EN61000-4-11	>95% dip 0.5 periods, 30% dip 25 periods, >95% interruptions 250 periods		
OTHERS	MTBF	1305.62 K hrs min. Telcordia SR-332 (Bellcore) 399.88Khrs min. MIL-HDBK-217F (25°C)		
	DIMENSION	105*63*30mm (L*W*H)		
	PACKING	0.41Kg;24pcs/ 10.5Kg/0.68CUFT for A-type 0.42Kg;24pcs/ 11Kg/0.68CUFT for AB-type		
NOTE	<ol style="list-style-type: none"> All parameters NOT specially mentioned are measured at 230VAC input, rated current and 25°C of ambient temperature. Please refer to "DRIVING METHODS OF LED MODULE". Length of set up time is measured at first cold start. Turning ON/OFF the driver may lead to increase of the set up time. De-rating may be needed under low input voltages. Please refer to "STATIC CHARACTERISTIC" sections for details. The driver is considered as a component that will be operated in combination with final equipment. Since EMC performance will be affected by the complete installation, the final equipment manufacturers must re-qualify EMC Directive on the complete installation again. This series meets the typical life expectancy of >50,000 hours of operation when Tcase, particularly (C) point (or TMP, per DLC), is about 80°C or less. Please refer to the warranty statement on MEAN WELL's website at http://www.meanwell.com Input over voltage only for XLG-25 I series ,and I series without UL/CSA certificate. The ambient temperature derating of 3.5°C/1000m with fanless models and of 5°C/1000m with fan models for operating altitude higher than 2000m(6500ft). Only for XLG-25-A Products sourced from the Americas regions may not have the CCC/PSE/BIS/KC logo. Please contact your MEAN WELL sales for more information. For any application note and IP water proof function installation caution, please refer our user manual before using. https://www.meanwell.com/Upload/PDF/LED_EN.pdf Ripple & noise are measured at 20MHz of bandwidth by using a 12" twisted pair-wire terminated with a 0.1uf & 47uf parallel capacitor. To fulfill requirements of the latest ErP regulation for lighting fixture, this LED driver can only be used behind a switch without permanently connected to the mains. If you need the NOM (Mexico) certificate, Please contact MEAN WELL sales representative for details. 			
<p>⊗ Product Liability Disclaimer : For detailed information, please refer to https://www.meanwell.com/serviceDisclaimer.aspx File Name:XLG-25-SPEC_2021-05-17</p>				

■ Block Diagram

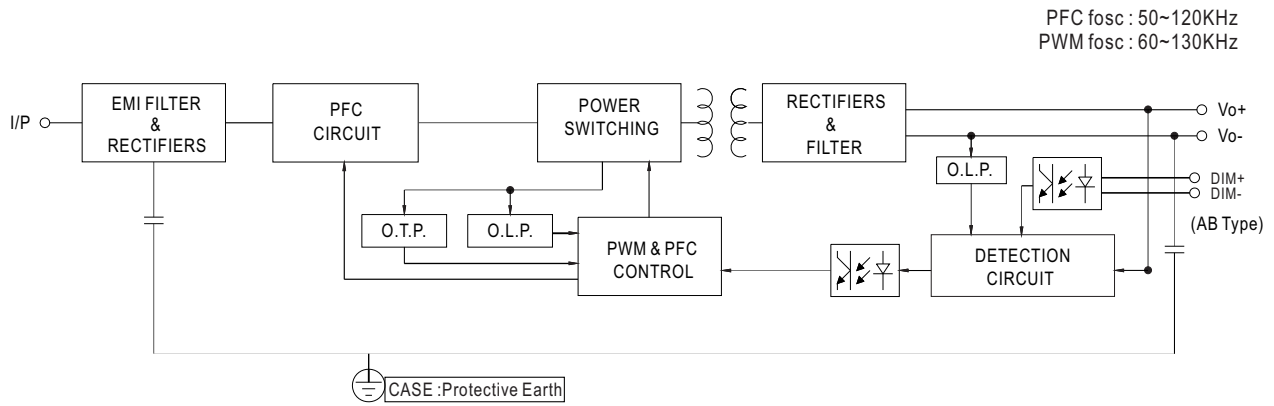

■ DRIVING METHODS OF LED MODULE

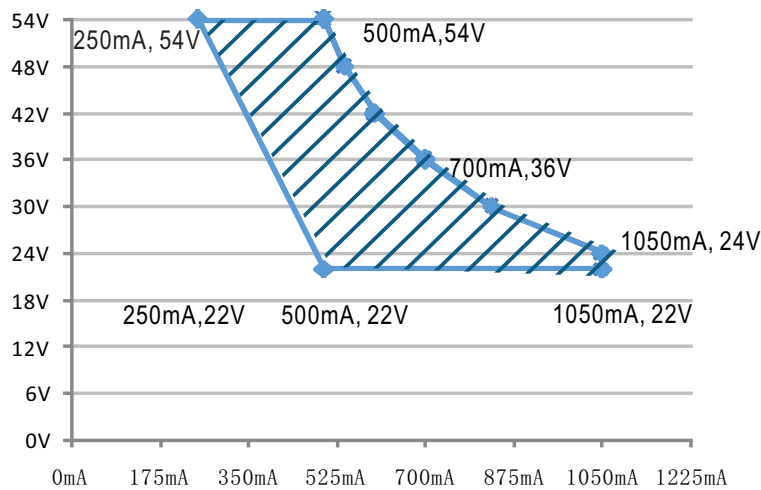

Recommend Performance Region

■ DIMMING OPERATION

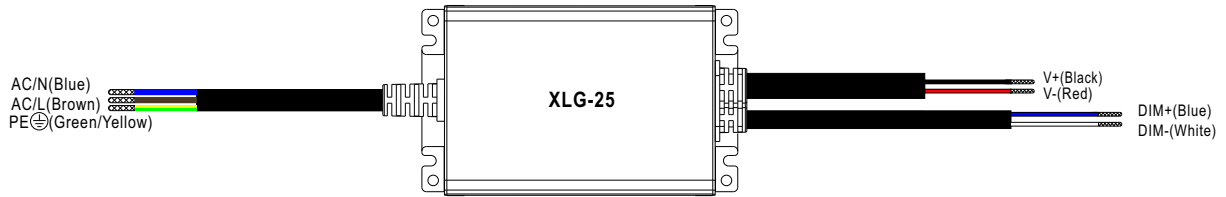

※ **3 in 1 dimming function (for AB-Type)**

- Output constant current level can be adjusted by applying one of the three methodologies between DIM+ and DIM-: 0 ~ 10VDC, or 10V PWM signal or resistance.
- Direct connecting to LEDs is suggested. It is not suitable to be used with additional drivers.
- Dimming source current from power supply: 100 μ A (typ.)

◎ Applying additive 0 ~ 10VDC

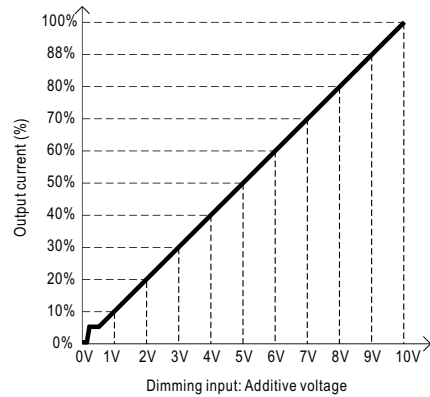
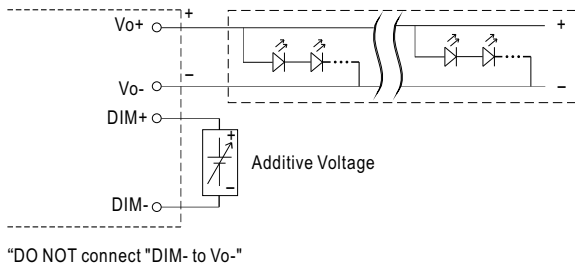

◎ Applying additive 10V PWM signal (frequency range 100Hz ~ 3KHz):

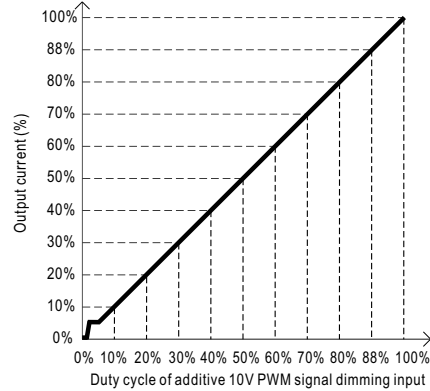

◎ Applying additive resistance:

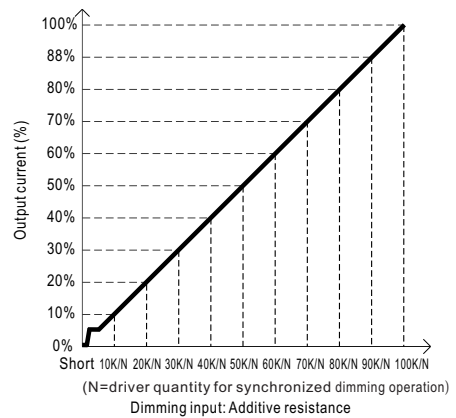
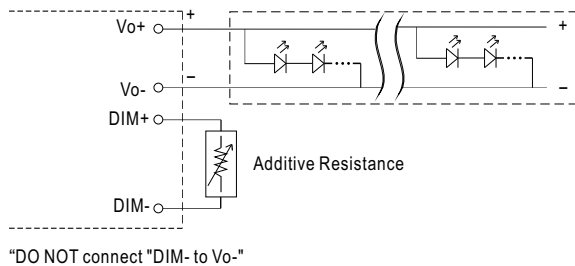

Note : 1. Min. dimming level is about 8% and the output current is not defined when 0% < Iout < 8%.
 2. The output current could drop down to 0% when dimming input is about 0k Ω or 0Vdc, or 10V PWM signal with 0% duty cycle.

OUTPUT LOAD vs TEMPERATURE

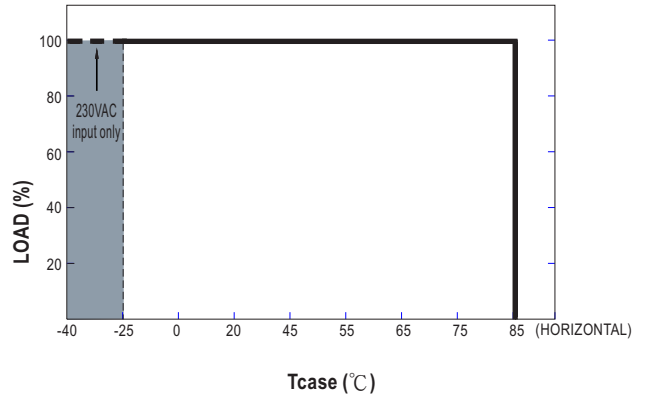
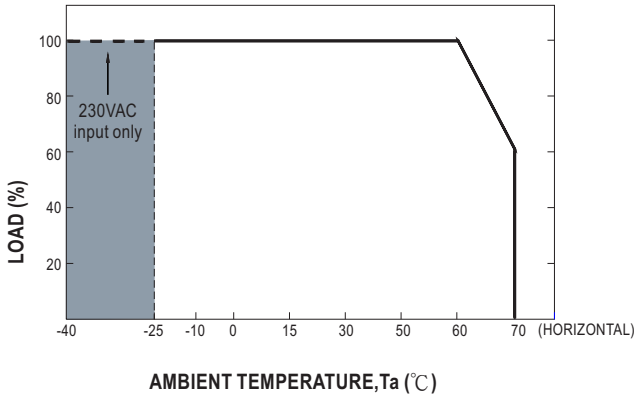

STATIC CHARACTERISTIC

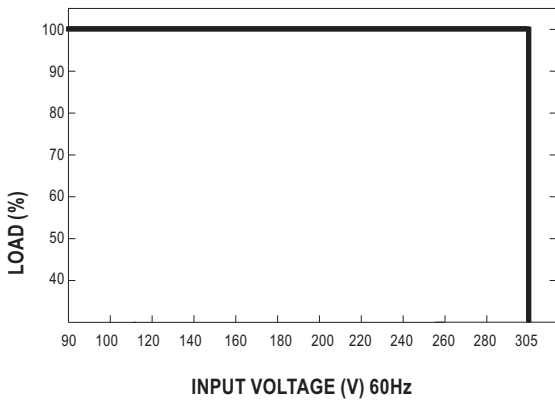

POWER FACTOR (PF) CHARACTERISTIC

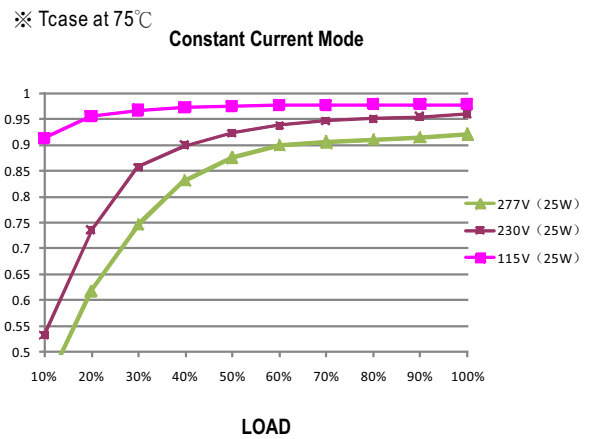

TOTAL HARMONIC DISTORTION (THD)

※ 50V Model, Tcase at 75°C

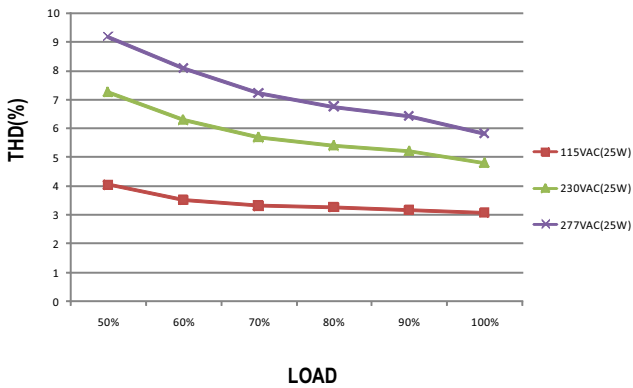

EFFICIENCY vs LOAD

XLG-25 series possess superior working efficiency that up to 88% can be reached in field applications.

※ 50V Model, Tcase at 75°C

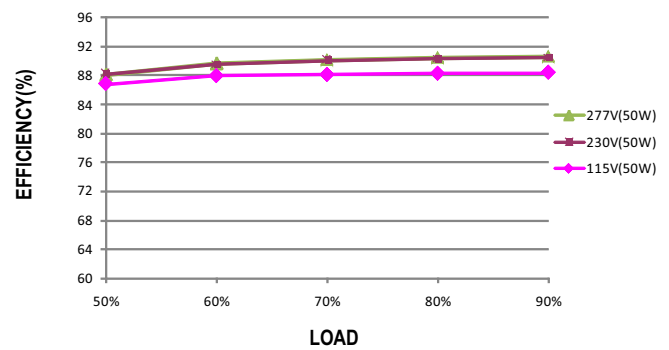



■ LIFE TIME

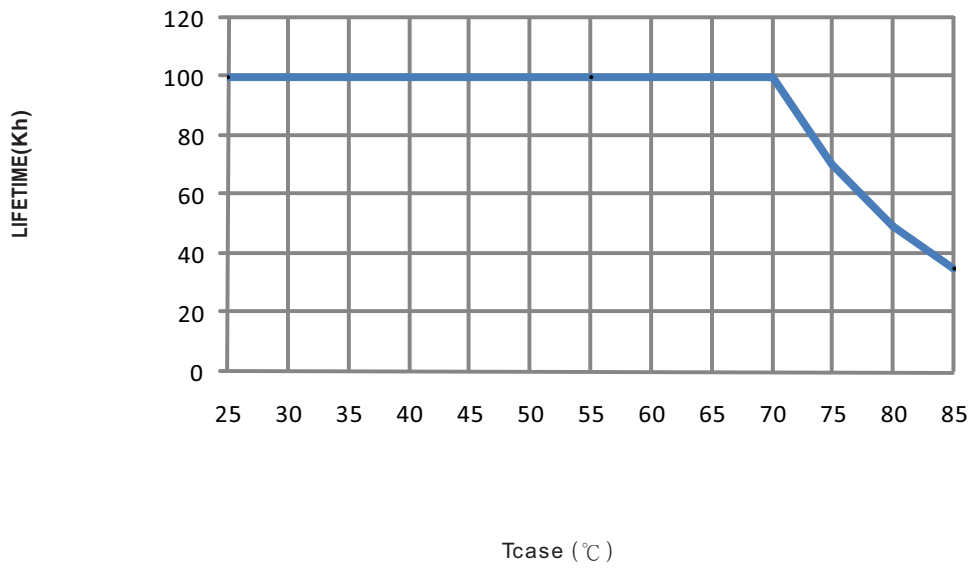

■ Mechanical Specification

※ A-Type

CASE NO.: 268A

Unit:mm

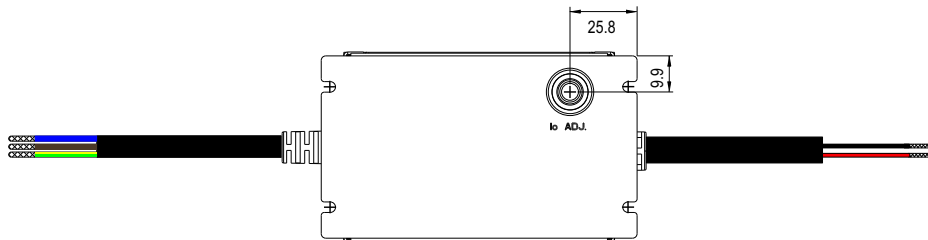
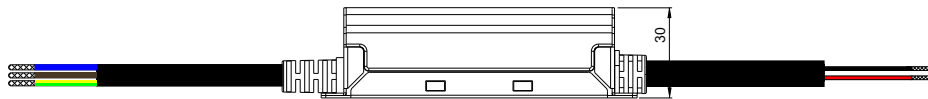
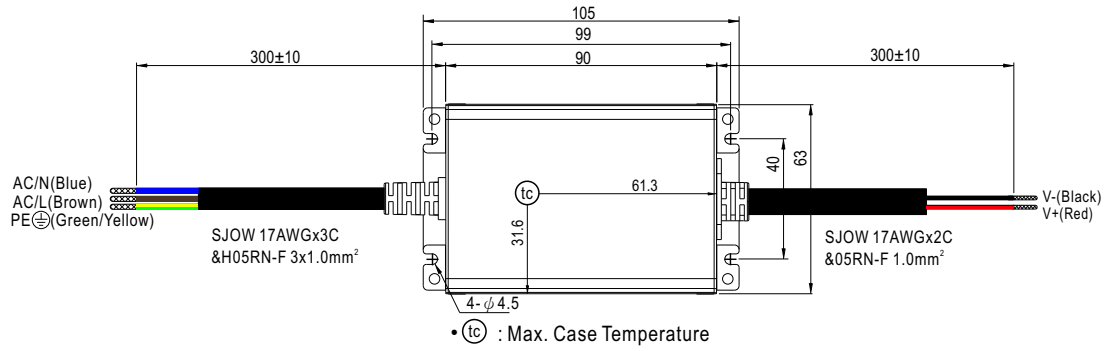

※ AB-Type

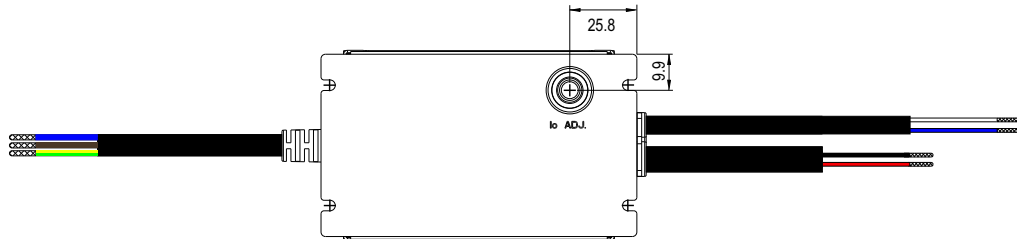
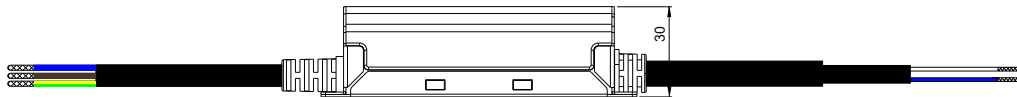
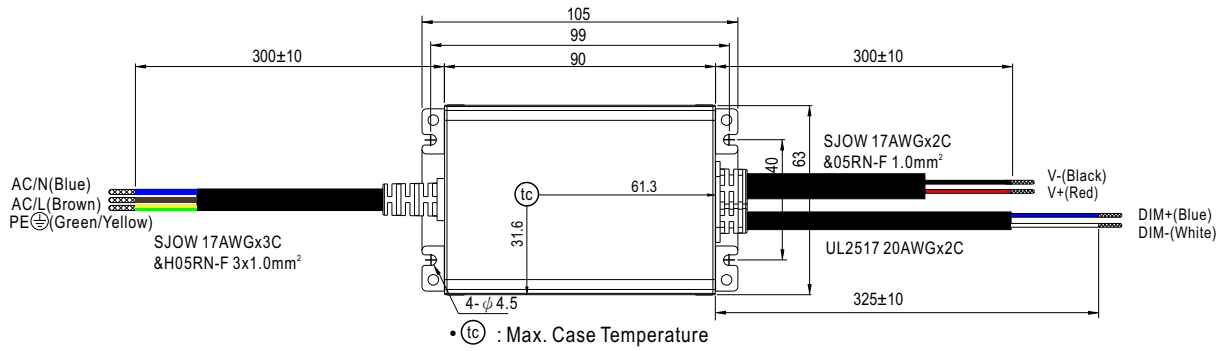

■ Installation Manual

Please refer to : <http://www.meanwell.com/manual.html>