



Micro Commercial Components

Micro Commercial Components
 20736 Marilla Street Chatsworth
 CA 91311
 Phone: (818) 701-4933
 Fax: (818) 701-4939

FR201 THRU FR207

Features

- Case Material: Molded Plastic. UL Flammability Classification Rating 94V-0 and MSL rating1
- High Current Capability
- Fast Switching Speed For High Efficiency
- Lead Free Finish/RoHS Compliant (Note1) ("P" Suffix designates Compliant. See ordering information)

2 Amp Fast Recovery Rectifier 50 to 1000 Volts

Maximum Ratings

- Operating Temperature: -55°C to +150°C
- Storage Temperature: -55°C to +150°C

Microsemi Catalog Number	Device Marking	Maximum Recurrent Peak Reverse Voltage	Maximum RMS Voltage	Maximum DC Blocking Voltage
FR201	FR201	50V	35V	50V
FR202	FR202	100V	70V	100V
FR203	FR203	200V	140V	200V
FR204	FR204	400V	280V	400V
FR205	FR205	600V	420V	600V
FR206	FR206	800V	560V	800V
FR207	FR207	1000V	700V	1000V

DO-15

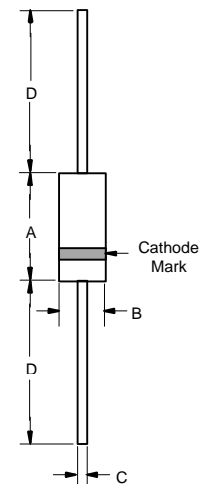

Electrical Characteristics @ 25°C Unless Otherwise Specified

Average Forward Current	$I_{F(AV)}$	2 A	$T_A = 55^\circ\text{C}$
Peak Forward Surge Current	I_{FSM}	60A	8.3ms, half sine
Maximum Instantaneous Forward Voltage	V_F	1.3V	$I_{FM} = 2.0\text{A};$ $T_A = 25^\circ\text{C}$
Maximum DC Reverse Current At Rated DC Blocking Voltage	I_R	5.0 μA 100 μA	$T_A = 25^\circ\text{C}$ $T_A = 100^\circ\text{C}$
Maximum Reverse Recovery Time	T_{rr}	150ns 250ns 500ns	$I_F=0.5\text{A}, I_R=1.0\text{A},$ $I_{rr}=0.25\text{A}$
FR201-204 FR205 FR206-207			
Typical Junction Capacitance	C_J	40pF	Measured at 1.0MHz, $V_R=4.0\text{V}$

DIM	DIMENSIONS				NOTE
	INCHES		MM		
A	.230	.300	5.80	7.60	
B	.104	.140	2.60	3.60	
C	.026	.034	.70	.90	
D	1.000	---	25.40	---	

Note: 1. High Temperature Solder Exemption Applied, see EU Directive Annex 7.

FR201 thru FR207

Figure 1
Typical Forward Characteristics

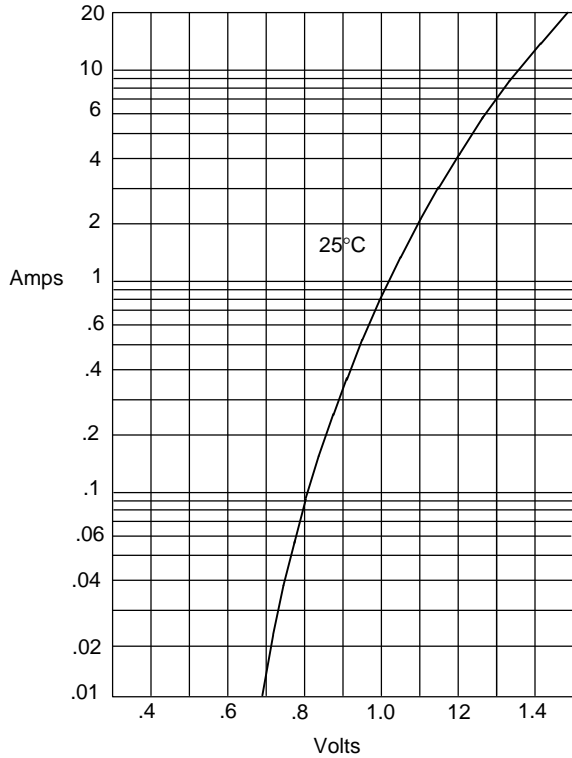

Instantaneous Forward Current - Amperes *versus*
Instantaneous Forward Voltage - Volts

Figure 2
Forward Derating Curve

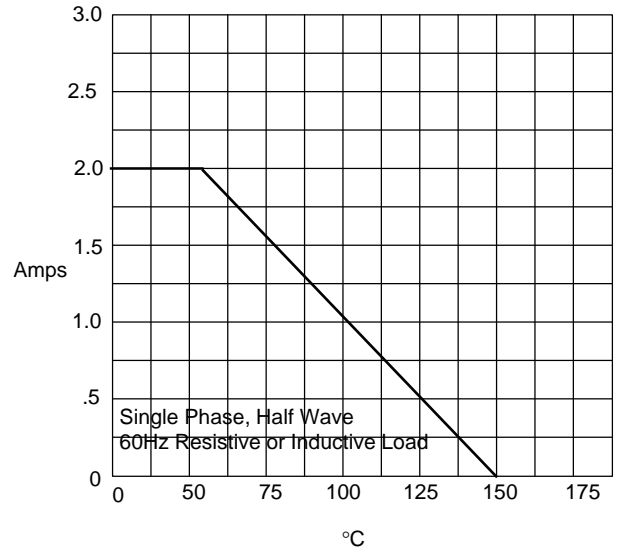

Average Forward Rectified Current - Amperes *versus*
Ambient Temperature - °C

Figure 3
Junction Capacitance

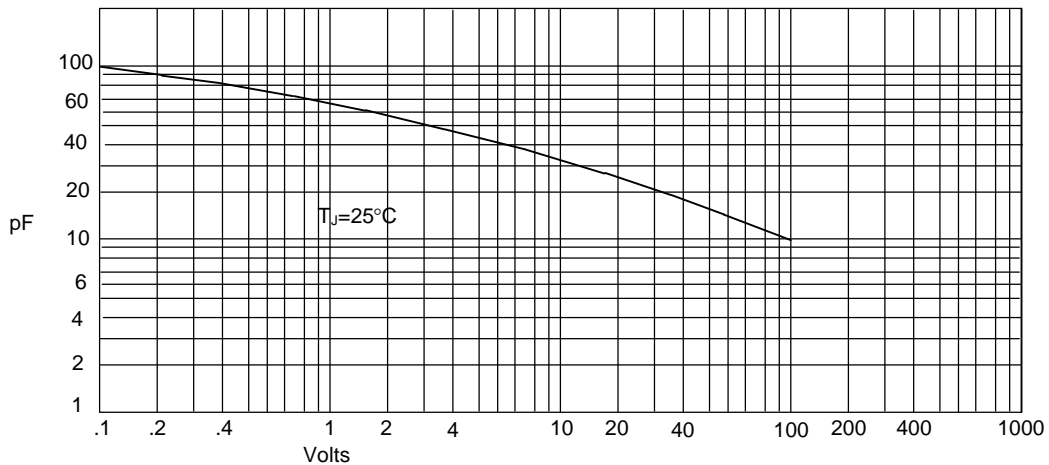

Junction Capacitance - pF *versus*
Reverse Voltage - Volts

Figure 4
Maximum Non-Repetitive Forward Surge Current

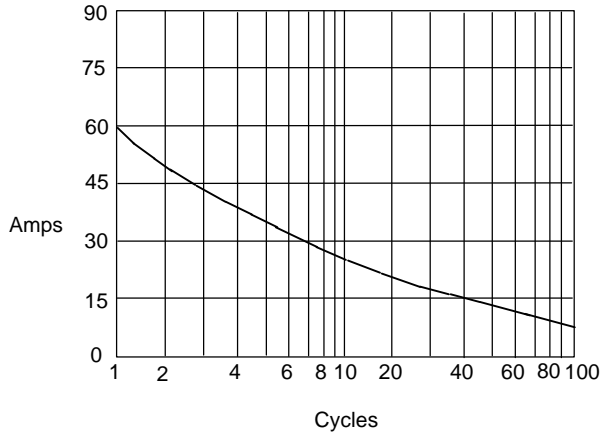

Peak Forward Surge Current - Amperes versus
Number Of Cycles At 60Hz - Cycles

Figure 5
Reverse Recovery Time Characteristic And Test Circuit Diagram

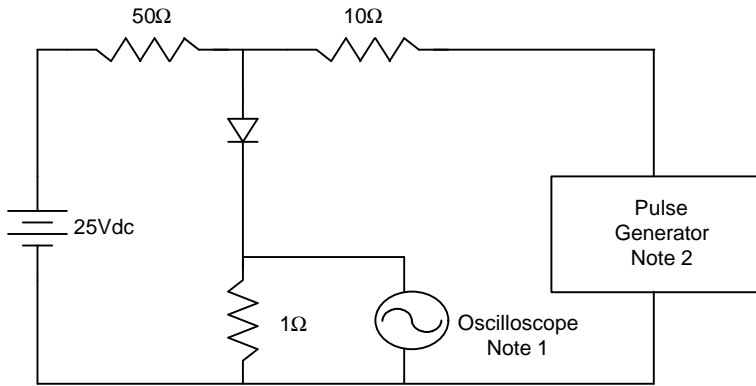

- Notes:
1. Rise Time = 7ns max.
Input impedance = 1 megohm, 22pF
 2. Rise Time = 10ns max.
Source impedance = 50 ohms
 3. Resistors are non-inductive

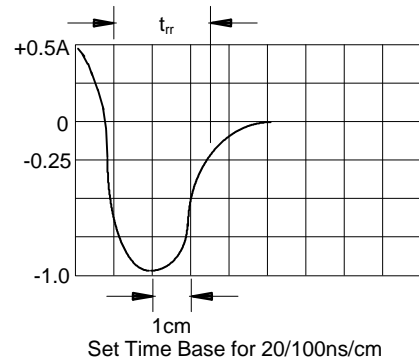



Micro Commercial Components

Ordering Information

Device	Packing
(Part Number)-TP	Tape&Reel;4Kpcs/Reel
(Part Number)-BP	Bulk;500pcs/Box

*****IMPORTANT NOTICE*****

Micro Commercial Components Corp. reserves the right to make changes without further notice to any product herein to make corrections, modifications , enhancements , improvements , or other changes . *Micro Commercial Components Corp.* does not assume any liability arising out of the application or use of any product described herein; neither does it convey any license under its patent rights ,nor the rights of others . The user of products in such applications shall assume all risks of such use and will agree to hold *Micro Commercial Components Corp.* and all the companies whose products are represented on our website, harmless against all damages.

*****APPLICATIONS DISCLAIMER*****

Products offer by *Micro Commercial Components Corp.* are not intended for use in Medical, Aerospace or Military Applications.