

Current Transducer HAL 300-S

$I_{PN} = 300 \text{ A}$

For the electronic measurement of DC, AC and pulsed currents, with a galvanic isolation between the primary (high power) circuit and the secondary (electronic) circuit.

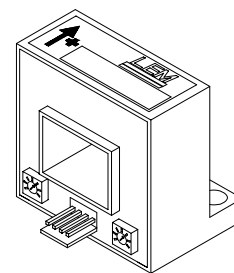

Electrical data

I_{PN}	Primary nominal DC or rms current	300	A
I_P	Primary current, measuring range	0 .. ± 900	A
\hat{I}_P	Overload capacity (Ampere Turns)	30000	A
V_{OUT}	Analogue output voltage @ $\pm I_{PN}$	± 4	V
R_L	Load resistance $T_A = 0 \dots +70^\circ\text{C}$	> 1	k Ω
		$T_A = -25 \dots +85^\circ\text{C}$	> 3
V_C	Supply voltage ($\pm 5\%$)	± 15	V
I_C	Current consumption (max)	25	mA
V_b	Rms rated voltage ¹⁾	500	V
V_d	Rms voltage for AC isolation test, 50 Hz, 1 mn	3	kV
R_{is}	Isolation resistance @ 500 V _{DC}	> 500	M Ω

Accuracy - Dynamic performance data

X	Accuracy ²⁾ @ $I_{PN}, T_A = 25^\circ\text{C}, @ \pm 15 \text{ V}$	± 1	%
ϵ_L	Linearity ²⁾	± 0.5	%
		Max	
V_{OE}	Electrical offset voltage @ $I_P = 0, T_A = 25^\circ\text{C}$	± 10	mV
V_{OM}	Residual offset voltage @ $I_P = 0$ after an overload of $3 \times I_{PN}$	± 10	mV
V_{OT}	Thermal drift of offset voltage $T_A = -25 \dots +85^\circ\text{C}$	± 1	mV/ $^\circ\text{C}$
TCE_G	Thermal drift of gain $T_A = -25 \dots +85^\circ\text{C}$	± 0.05	%/ $^\circ\text{C}$
t_r	Response time @ 90 % of I_P	< 3	μs
di/dt	di/dt accurately followed	> 50	A/ μs
f	Frequency bandwidth (-3 dB) ³⁾	DC .. 50	kHz

General data

T_A	Ambient operating temperature	-25 .. +85	$^\circ\text{C}$
T_S	Ambient storage temperature	-25 .. +85	$^\circ\text{C}$
m	Mass	75	g
	Standards	Safety	EN50178 (1994)
		EMC	EN50082-2 (1992)
			EN50081-1 (1992)
	Deviation in output when tested to EN 61000-4-6	< 10	% of I_{PN}
	Deviation in output when tested to EN 61000-4-4	< 10	% of I_{PN}

Features

- Open loop transducer using Hall Effect
- Panel mounting - Horizontal or Vertical
- Insulated plastic case to UL 94-V0.

Advantages

- Very good linearity
- Very good accuracy
- Low temperature drift
- Wide frequency bandwidth
- Very low insertion losses
- High immunity to external interference
- Current overload capability
- Low power consumption
- Wide dynamic range, 50 to 600 A in one package.

Applications

- AC variable speed drives and servo motor drives
- Static converters for DC motor drives
- Battery supplied applications
- Uninterruptable Power Supplies (UPS)
- Switched Mode Power Supplies (SMPS)
- Power supplies for welding applications.

Notes : ¹⁾ Overvoltage Category III, Pollution Degree 2

²⁾ Excludes the electrical offset

³⁾ Refer to derating curves in the technical file to avoid excessive core heating at high frequency

HAL300980903/1

Dimensions HAL 300-S (in mm. 1 mm = 0.0394 inch)

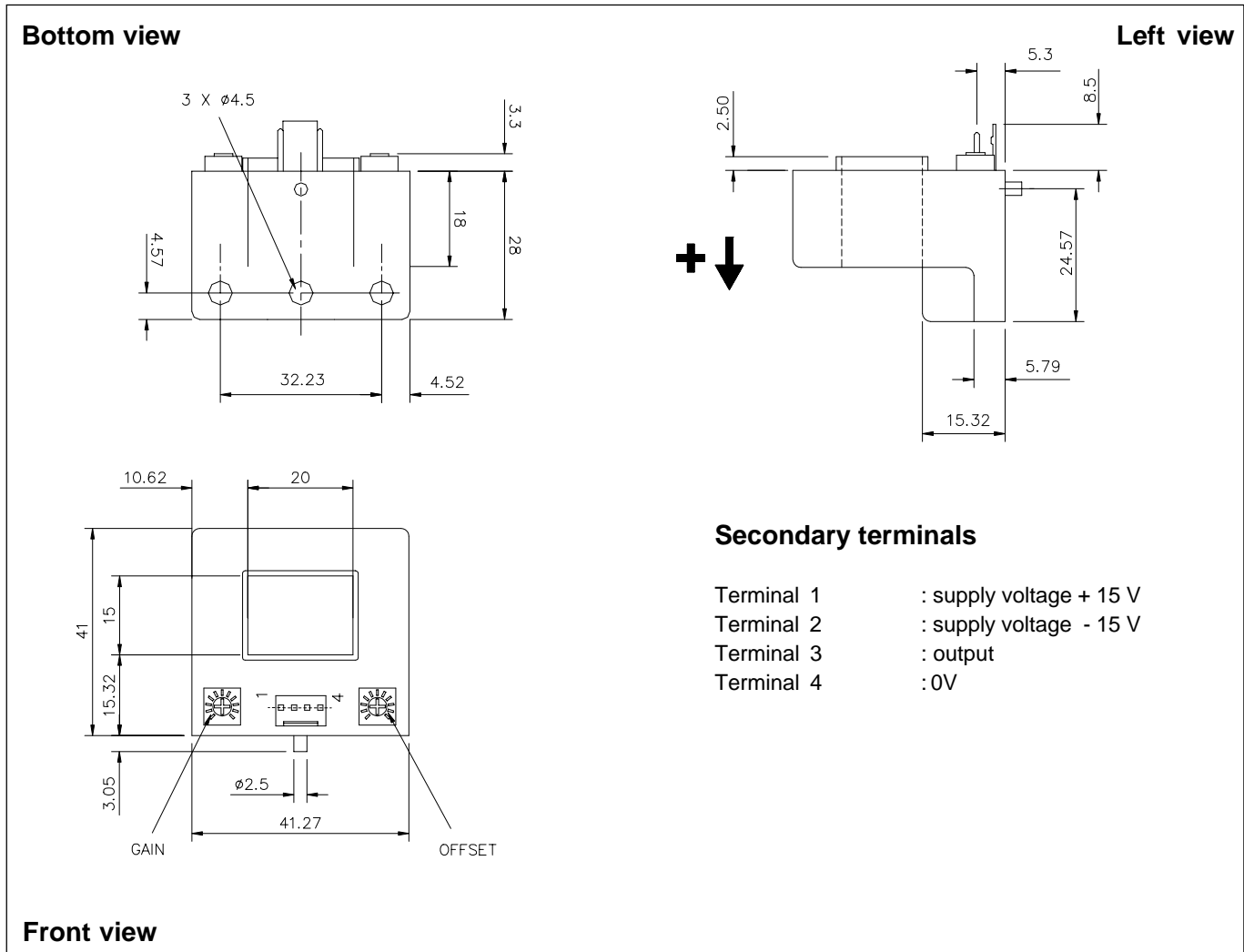

Mechanical characteristics

- General tolerance ± 0.5 mm
- Primary through-hole 20 mm x 15 mm
- Connection of secondary Molex 5045-04-A

Remarks

- V_{OUT} is positive when I_p flows in the direction of the arrow.
- Temperature of the primary conductor should not exceed 90°C.
- This is a standard model. For different versions (supply voltages, secondary connections, unidirectional measurements, operating temperatures, etc.) please contact us.