

Capacitor, aluminum, 10 uF, +/-20% Tol, 63V@85C

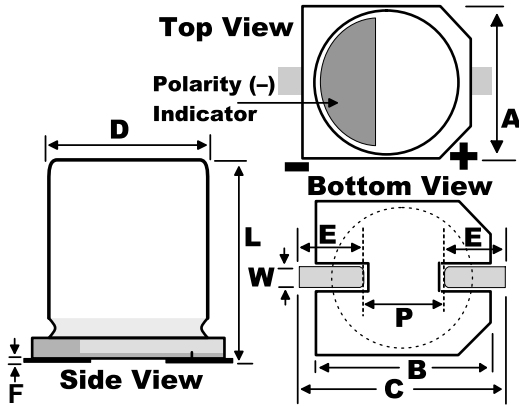

Dimensions (mm)		
Symbol	Dimension	Tolerance
D	6.3	+/-0.5
L	5.4	+0.25/-0.1
A	6.6	+/-0.2
B	6.6	+/-0.2
C	7.8	max
W	0.65	+/-0.1
E	2.6	+/-0.2
P	1.8	+/-0.2
F	0.3	max

Packaging Specifications	
Package Kind:	T&R
Package Size:	380mm
Package Quantity:	1000

General Information	
Manufacturer:	KEMET
Part Type Description:	Surface Mount Aluminum Electrolytic
Style:	Surface Mount Vertical Can
Lead Type:	V-Chip

Specifications	
Capacitance:	10 uF
Voltage @ rated temp:	63V
Rated Temperature:	85C
Tolerance:	+/-20%
VDC Surge:	79WVDC
Life @ rated temp:	2000 h
RoHS:	Yes
Hi Temp Solder:	Yes
Temperature Range:	-40/+85C
Leakage Current:	6 uA
Leakage Condition:	2min/20c
Dissipation Factor:	18%
Impedance Ratio -25C:	2.0
Impedance Ratio -40C:	3.0
Ripple 120Hz @ rated temp:	0.02 A
Ripple 120Hz @ alt temp:	0.0272 A
Ripple 120Hz alt temp:	50C