

Three Phase Rectifier Bridge

$I_{dAV} = 63/88 \text{ A}$
 $V_{RRM} = 800-1800 \text{ V}$

V_{RRM} V	V_{RSM} V	Type	
800	900	VUO 62-08NO7	VUO 82-08NO7
1200	1300	VUO 62-12NO7	VUO 82-12NO7
1400	1500	VUO 62-14NO7	VUO 82-14NO7
1600	1700	VUO 62-16NO7	VUO 82-16NO7
1800	1900	VUO 62-18NO7*	VUO 82-18NO7*

* delivery time on request

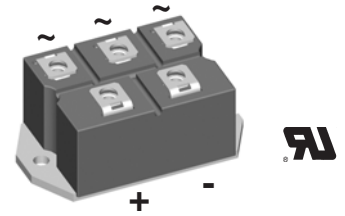
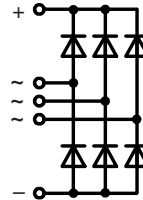

Symbol	Conditions	Maximum Ratings		
		VUO 62	VUO 82	
I_{dAV}	$T_C = 110^\circ\text{C}$; module	63	88	A
I_{dAV}	$T_A = 45^\circ\text{C}$ ($R_{thCA} = 0.6 \text{ K/W}$); module	48	57	A
I_{FSM}	$T_{VJ} = 45^\circ\text{C}$; $t = 10 \text{ ms}$ (50 Hz); sine	550	750	A
	$V_R = 0 \text{ V}$; $t = 8.3 \text{ ms}$ (60 Hz); sine	600	820	A
I_{FSM}	$T_{VJ} = T_{VJM}$; $t = 10 \text{ ms}$ (50 Hz); sine	500	670	A
	$V_R = 0 \text{ V}$; $t = 8.3 \text{ ms}$ (60 Hz); sine	550	740	A
I^2t	$T_{VJ} = 45^\circ\text{C}$; $t = 10 \text{ ms}$ (50 Hz), sine	1520	2800	A^2s
	$V_R = 0 \text{ V}$; $t = 8.3 \text{ ms}$ (60 Hz), sine	1520	2800	A^2s
I^2t	$T_{VJ} = T_{VJM}$; $t = 10 \text{ ms}$ (50 Hz), sine	1250	2250	A^2s
	$V_R = 0 \text{ V}$; $t = 8.3 \text{ ms}$ (60 Hz), sine	1250	2250	A^2s
T_{VJ}		-40...+150		$^\circ\text{C}$
T_{VJM}		150		$^\circ\text{C}$
T_{stg}		-40...+125		$^\circ\text{C}$
V_{ISOL}	50/60Hz RMS; $t = 1 \text{ min}$	2500		V~
	$I_{ISOL} \leq 1 \text{ mA}$; $t = 1 \text{ s}$	3000		V~
M_d	Mounting torque (M5)	5 $\pm 15\%$		Nm
	Terminal connection torque (M5)	5 $\pm 15\%$		Nm
Weight	typ.	160		g

Features

- Package with screw terminals
- Isolation voltage 3000 V~
- Planar passivated chips
- Blocking voltage up to 1800 V
- Low forward voltage drop
- UL registered E72873

Applications

- Supplies for DC power equipment
- Input rectifiers for PWM inverter
- Battery DC power supplies
- Field supply for DC motors

Advantages

- Easy to mount with two screws
- Space and weight savings
- Improved temperature and power cycling

Dimensions in mm (1 mm = 0.0394")

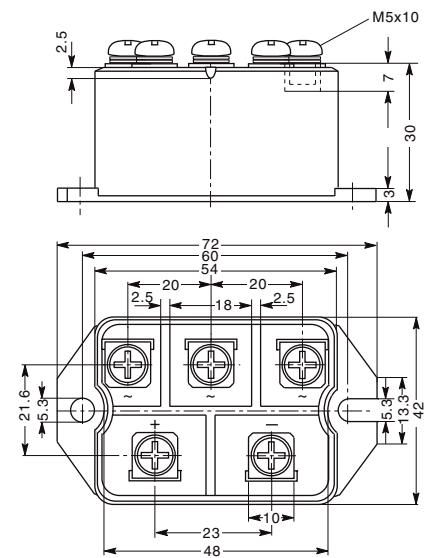

Symbol	Conditions	Characteristic Values		
		VUO 62	VUO 82	
I_R	$V_R = V_{RRM}$; $T_{VJ} = 25^\circ\text{C}$	≤ 0.3	0.3	mA
	$V_R = V_{RRM}$; $T_{VJ} = T_{VJM}$	≤ 5	5	mA
V_F	$I_F = 150 \text{ A}$; $T_{VJ} = 25^\circ\text{C}$	≤ 1.8	1.6	V
V_{T0}	For power-loss calculations only	0.8	0.8	V
r_T		8	5	$\text{m}\Omega$
R_{thJC}	per diode	1.45	1.1	K/W
	per module	0.24	0.183	K/W
R_{thJH}	per diode	1.87	1.52	K/W
	per module	0.31	0.253	K/W
d_s	Creeping distance on surface	10		mm
d_A	Creepage distance in air	9.4		mm
a	Max. allowable acceleration	50		m/s^2

Data according to IEC 60747 and refer to a single diode unless otherwise stated.
 IXYS reserves the right to change limits, test conditions and dimensions.

20080811a

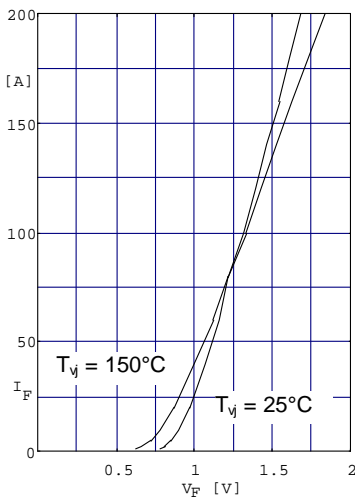

Fig. 1 Forward current versus voltage drop per diode

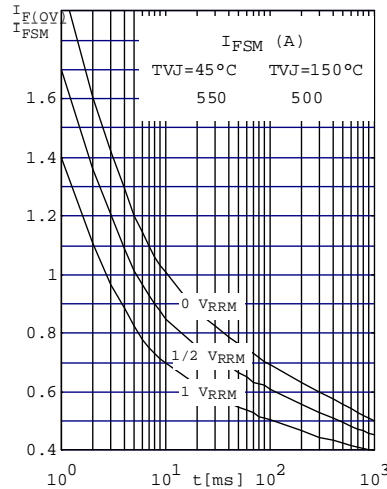

Fig. 2 Surge overload current per diode
I_{FSM}: Crest value. t: duration

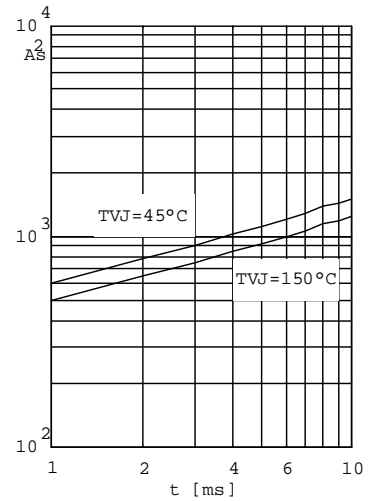

Fig. 3 $\int i^2 dt$ versus time (1-10ms) per diode or thyristor

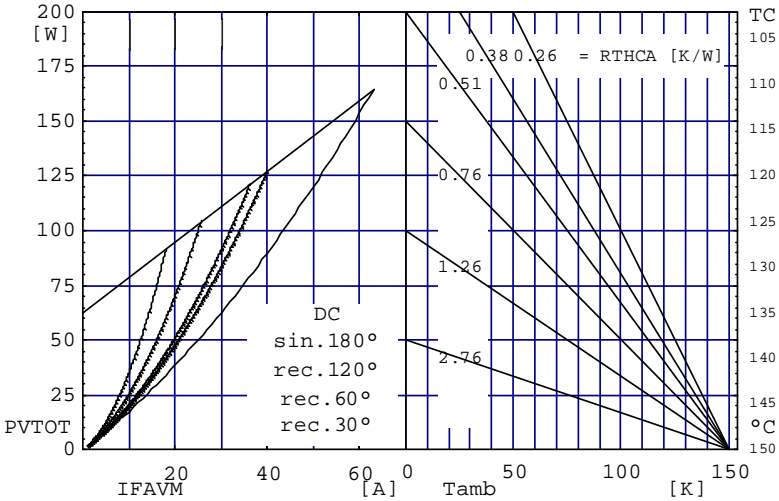

Fig. 4 Power dissipation versus direct output current and ambient temperature

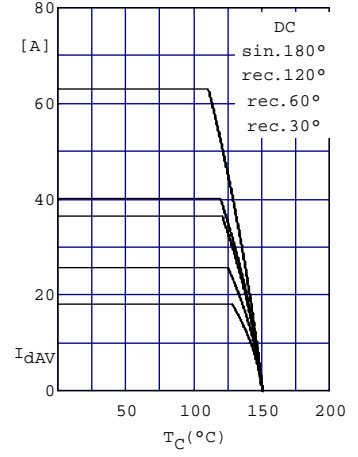

Fig.5 Maximum forward current at case temperature

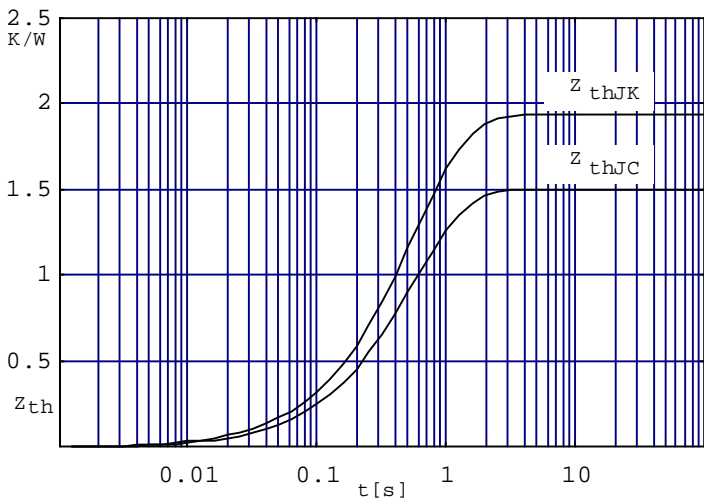

Fig. 6 Transient thermal impedance per diode or thyristor, calculated

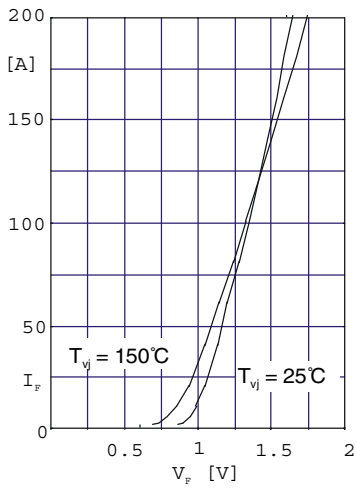

Fig. 1 Forward current versus voltage drop per diode

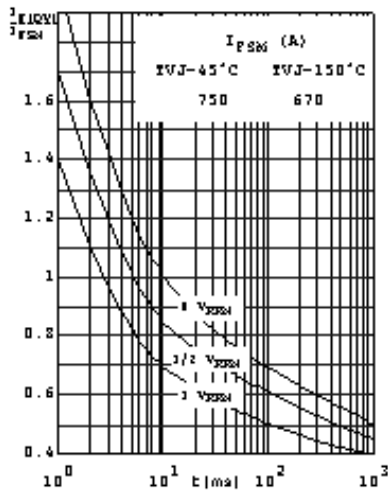

Fig. 2 Surge overload current per diode I_{FSM} : Crest value
t: duration

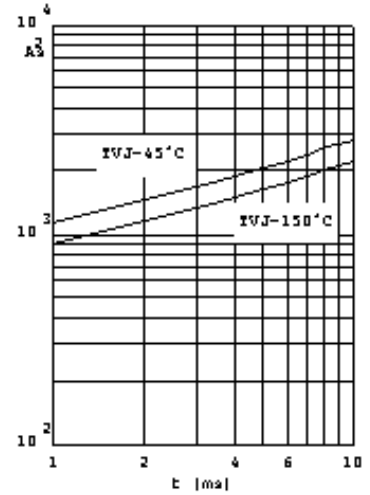

Fig. 3 $\int i^2 dt$ versus time (1-10ms) per diode (or thyristor)

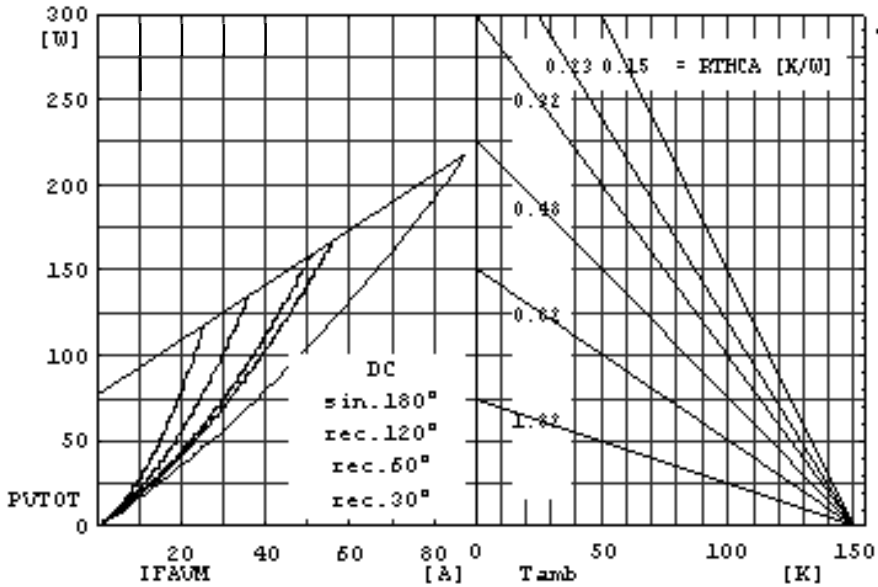

Fig. 4 Power dissipation versus direct output current and ambient temperature

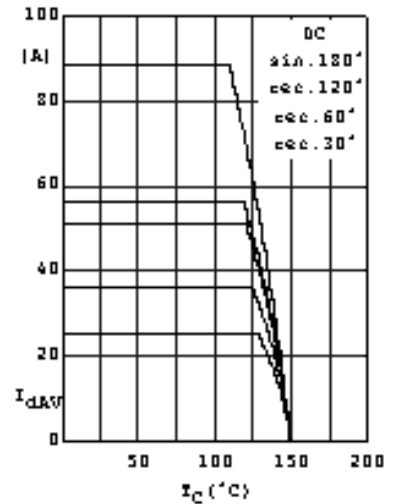

Fig.5 Maximum forward current at case temperature

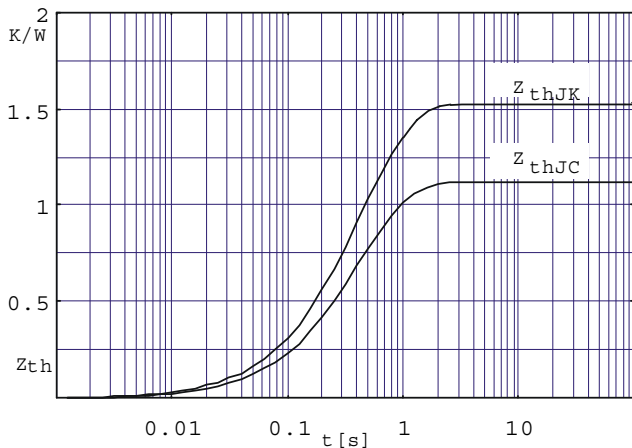

Fig. 6 Transient thermal impedance per diode (or thyristor), calculated