

**STANDARD DIODES**

**SUPER MAGN-A-pak™ Power Modules**

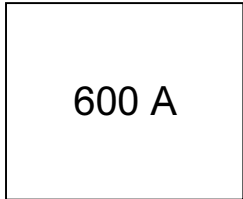

**Features**

- High current capability
- 3000 V<sub>RMS</sub> isolating voltage with non-toxic substrate
- High surge capability
- High voltage ratings up to 2000V
- Industrial standard package
- UL E78996 approved

**Typical Applications**

- Rectifying bridge for large motor drives
- Rectifying bridge for large UPS

**Major Ratings and Characteristics**

Parameters	IRKD600..	Units
$I_{F(AV)}$	600	A
@T <sub>C</sub>	100	°C
$I_{F(RMS)}$	942	A
@T <sub>C</sub>	100	°C
$I_{FSM}$	@50Hz 19.0	KA
	@60Hz 20.1	KA
$i^2t$	@50Hz 1805	KA <sup>2</sup> s
	@60Hz 1683	KA <sup>2</sup> s
$i^2\sqrt{t}$	18050	KA <sup>2</sup> √s
V <sub>RRM</sub> range	800 to 2000	V
T <sub>STG</sub> range	-40 to 150	°C
T <sub>J</sub> range	-40 to 150	°C

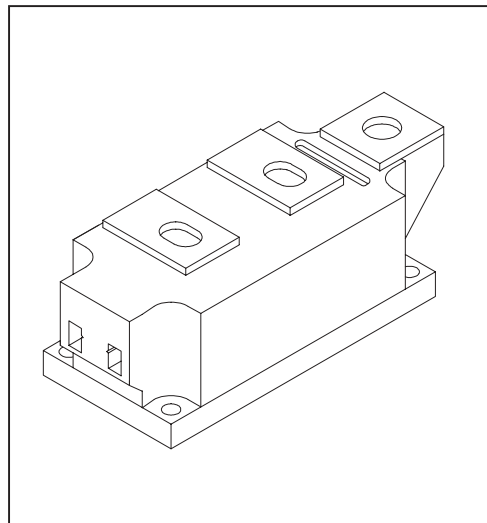

## ELECTRICAL SPECIFICATIONS

## Voltage Ratings

Type number	Voltage Code	$V_{RRM}$ , maximum repetitive peak reverse voltage V	$V_{RSM}$ , maximum non-repetitive peak rev. voltage V	$I_{RRM}$ max. @ $T_J$ max. mA
IRKD600..	08	800	900	50
	12	1200	1300	
	16	1600	1700	
	20	2000	2100	

## Forward Conduction

Parameter	IRKD600..	Units	Conditions
$I_{F(AV)}$ Maximum average forward current @ Case temperature	600	A	180° conduction, half sine wave
	100	°C	
$I_{F(RMS)}$ Maximum RMS forward current	942	A	180° conduction, half sine wave @ $T_C = 100^\circ\text{C}$
$I_{FSM}$ Maximum peak, one-cycle forward, non-repetitive surge current	19.0	KA	t = 10ms No voltage reappplied
	20.1		t = 8.3ms 100% $V_{RRM}$ reappplied
	16.2		t = 10ms 100% $V_{RRM}$ reappplied
	17.2		t = 8.3ms 100% $V_{RRM}$ reappplied
$I^2t$ Maximum $I^2t$ for fusing	1805	KA <sup>2</sup> s	t = 10ms No voltage reappplied
	1683		t = 8.3ms 100% $V_{RRM}$ reappplied
	1319		t = 10ms 100% $V_{RRM}$ reappplied
	1230		t = 8.3ms 100% $V_{RRM}$ reappplied
$I^2\sqrt{t}$ Maximum $I^2\sqrt{t}$ for fusing	18050	KA <sup>2</sup> \sqrt{s}	t = 0.1 to 10ms, no voltage reappplied
$V_{F(TO)1}$ Low level value of threshold voltage	0.70	V	$(16.7\% \times \pi \times I_{F(AV)} < I < \pi \times I_{F(AV)})$ , $T_J = T_J$ max.
$V_{F(TO)2}$ High level value of threshold voltage	0.77		$(I > \pi \times I_{F(AV)})$ , $T_J = T_J$ max.
$r_{f1}$ Low level value of forward slope resistance	0.28	mΩ	$(16.7\% \times \pi \times I_{F(AV)} < I < \pi \times I_{F(AV)})$ , $T_J = T_J$ max.
$r_{f2}$ High level value of forward slope resistance	0.25		$(I > \pi \times I_{F(AV)})$ , $T_J = T_J$ max.
$V_{FM}$ Maximum forward voltage drop	1.45	V	$I_{pk} = 1800\text{A}$ , $T_J = 25^\circ\text{C}$ , $t_p = 10\text{ms}$ sine pulse

## Blocking

Parameter	IRKD600..	Units	Conditions
$V_{INS}$ RMS isolation voltage	3000	V	t = 1 s
$I_{RRM}$ Maximum peak reverse and off-state leakage current	50	mA	$T_J = T_J$ max., rated $V_{RRM}$ applied

Thermal and Mechanical Specifications

Parameter	IRKD600..	Units	Conditions
T <sub>J</sub> Max. junction operating temperature range	-40 to 150	°C	
T <sub>stg</sub> Max. storage temperature range	-40 to 150		
R <sub>thJC</sub> Max. thermal resistance, junction to case	0.065	K/W	Per junction, DC operation
R <sub>thC-hs</sub> Max. thermal resistance, case to heatsink	0.02	K/W	
T Mounting torque ± 10%SMAP to heatsink busbar to SMAP	6 - 8 12 - 15	Nm	A mounting compound is recommended and the torque should be rechecked after a period of 3 hours to allow for the spread of the compound
wt Approximate weight	1500		
Case style	SUPER MAGN-A-pak		See outline table

$\Delta R_{thJC}$  Conduction

(The following table shows the increment of thermal resistance R<sub>thJC</sub> when devices operate at different conduction angles than DC)

Conduction angle	Sinusoidal conduction	Rectangular conduction	Units	Conditions
180°	0.009	0.006	K/W	T <sub>J</sub> = T <sub>J</sub> max.
120°	0.011	0.011		
90°	0.014	0.015		
60°	0.021	0.022		
30°	0.037	0.038		

Ordering Information Table

Device Code

IRK	D	600	-	20
①	②	③		④

- 1 - Module type
- 2 - Circuit configuration D = 2 diodes in series
- 3 - Current rating
- 4 - Voltage code: Code x 100 = V<sub>RRM</sub> (See Voltage Ratings Table)

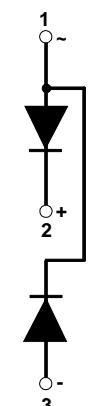

Outline Table

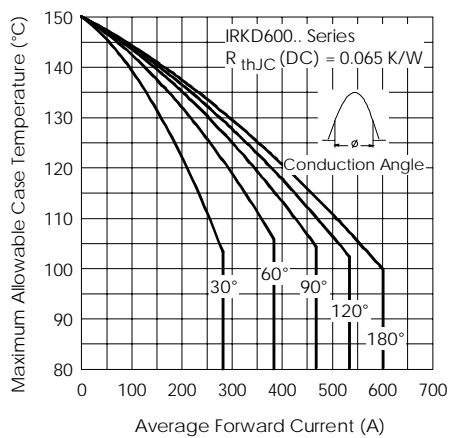
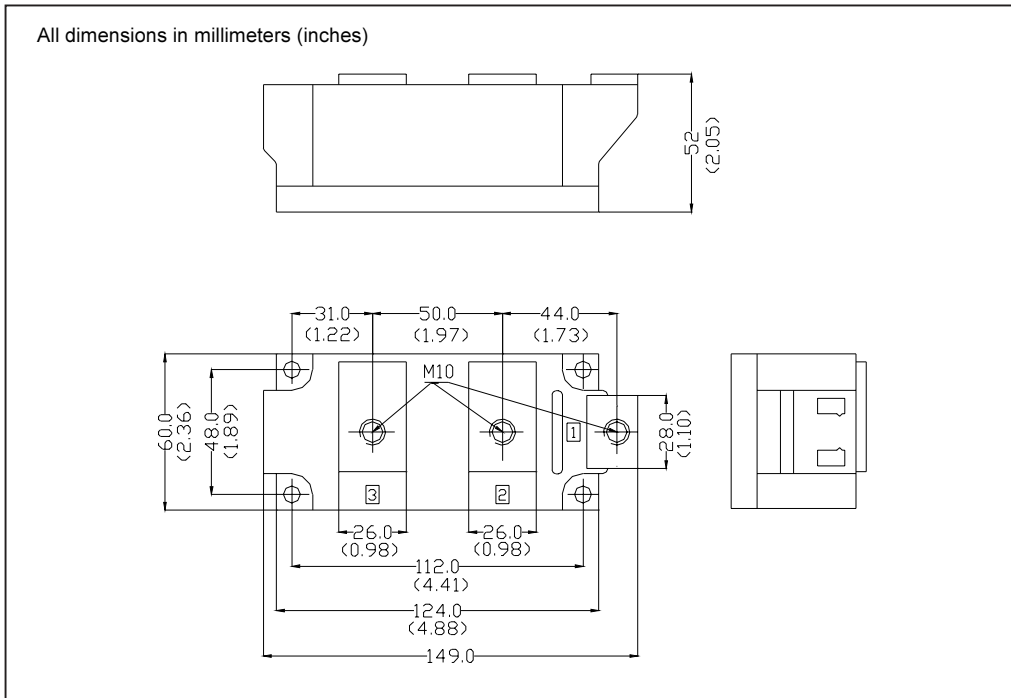

Fig. 1 - Current Ratings Characteristics

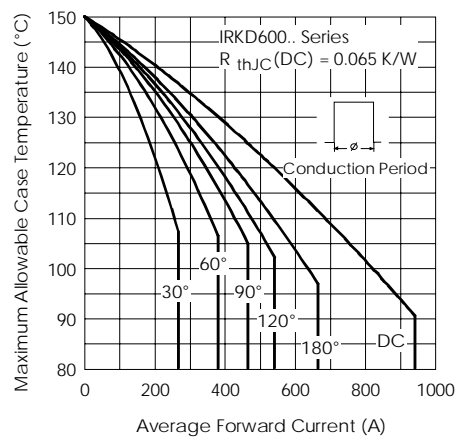

Fig. 2 - Current Ratings Characteristics

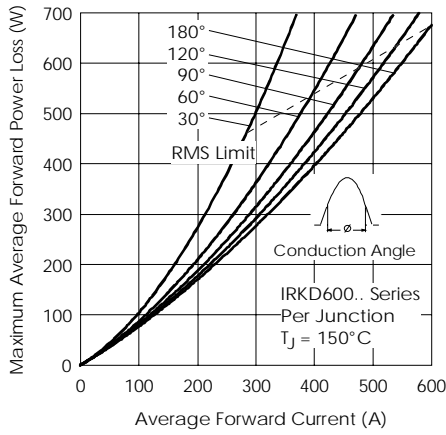

Fig. 3 - Forward Power Loss Characteristics

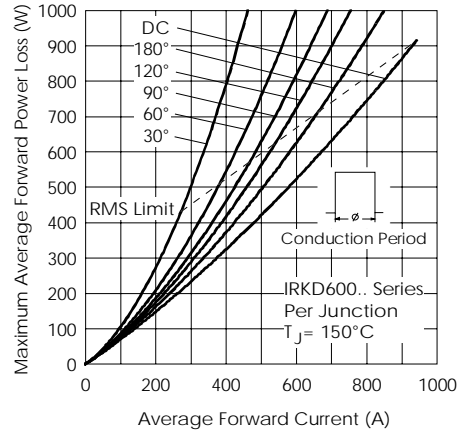

Fig. 4 - Forward Power Loss Characteristics

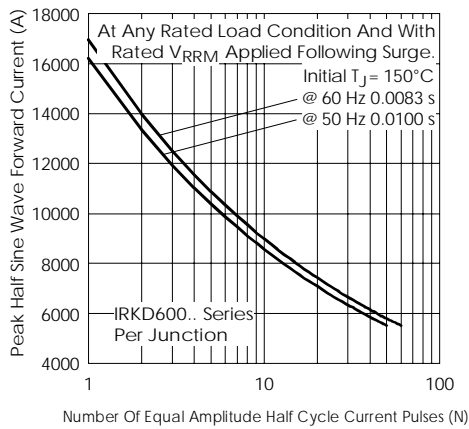

Fig. 5 - Maximum Non-Repetitive Surge Current

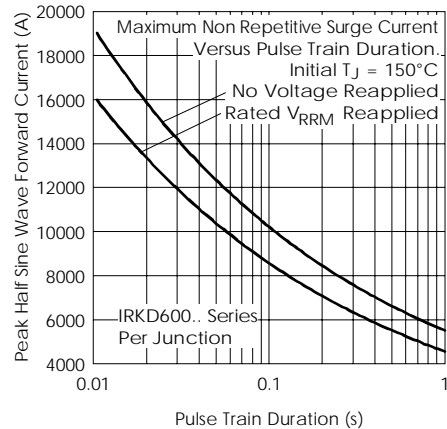

Fig. 6 - Maximum Non-Repetitive Surge Current

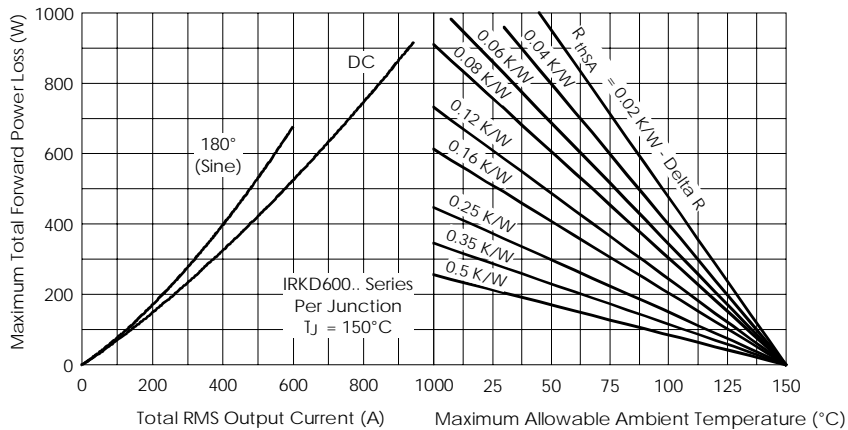

Fig. 7 - Forward Power Loss Characteristics

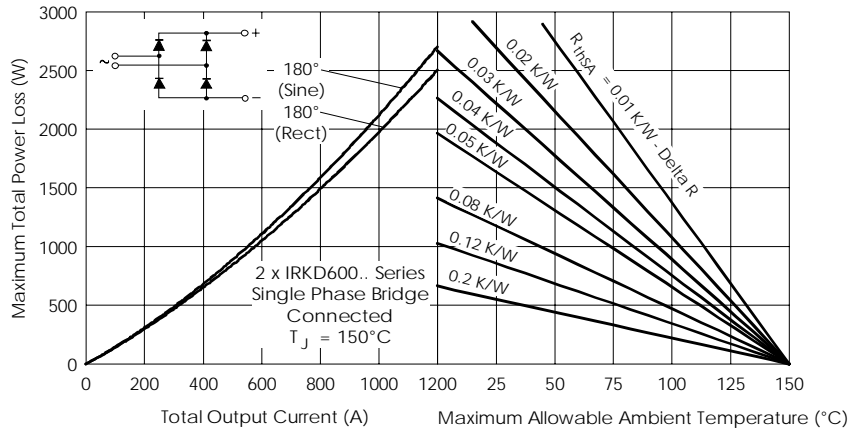

Fig. 8 - Forward Power Loss Characteristics

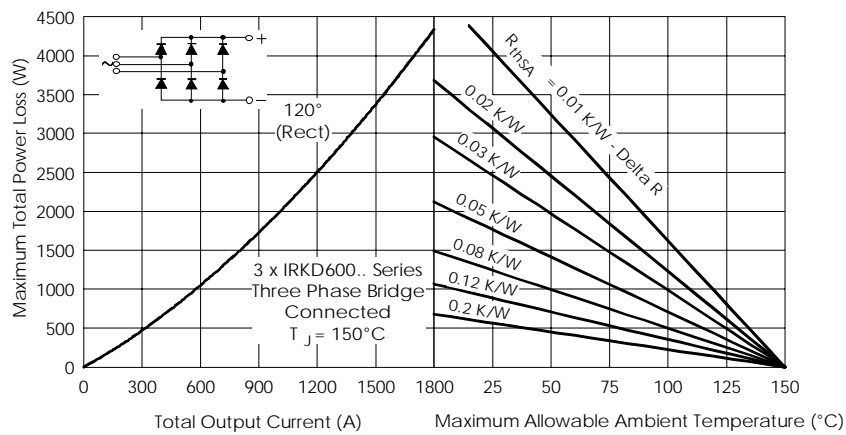

Fig. 9 - Forward Power Loss Characteristics

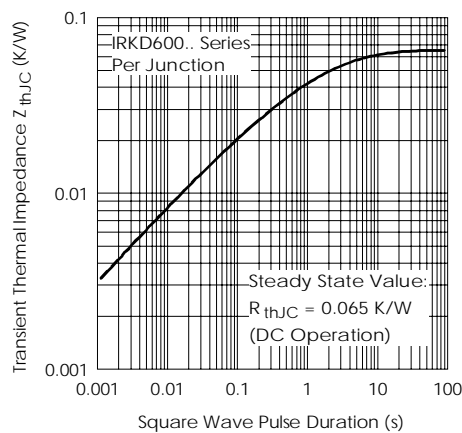

Fig. 10 - Thermal Impedance  $Z_{\theta JC}$  Characteristic