

## CD4017BC • CD4022BC

### Decade Counter/Divider with 10 Decoded Outputs • Divide-by-8 Counter/Divider with 8 Decoded Outputs

#### General Description

The CD4017BC is a 5-stage divide-by-10 Johnson counter with 10 decoded outputs and a carry out bit.

The CD4022BC is a 4-stage divide-by-8 Johnson counter with 8 decoded outputs and a carry out bit.

These counters are cleared to their zero count by a logical "1" on their reset line. These counters are advanced on the positive edge of the clock signal when the clock enable signal is in the logical "0" state.

The configuration of the CD4017BC and CD4022BC permits medium speed operation and assures a hazard free counting sequence. The 10/8 decoded outputs are normally in the logical "0" state and go to the logical "1" state only at their respective time slot. Each decoded output remains high for 1 full clock cycle. The carry-out signal completes a full cycle for every 10/8 clock input cycles and is used as a ripple carry signal to any succeeding stages.

#### Features

- Wide supply voltage range: 3.0V to 15V
- High noise immunity:  $0.45 V_{DD}$  (typ.)
- Low power Fan out of 2 driving 74L TTL compatibility: or 1 driving 74LS
- Medium speed operation: 5.0 MHz (typ.) with  $10V V_{DD}$
- Low power: 10  $\mu$ W (typ.)
- Fully static operation

#### Applications

- Automotive
- Instrumentation
- Medical electronics
- Alarm systems
- Industrial electronics
- Remote metering

#### Ordering Code:

Order Number	Package Number	Package Description
CD4017BCM	M16A	16-Lead Small Outline Integrated Circuit (SOIC), JEDEC MS-012, 0.150" Narrow
CD4017BCSJ	M16D	16-Lead Small Outline Package (SOP), EIAJ TYPE II, 5.3mm Wide
CD4017BCN	N16E	16-Lead Plastic Dual-In-Line Package (PDIP), JEDEC MS-001, 0.300" Wide
CD4022BCM	M16A	16-Lead Small Outline Integrated Circuit (SOIC), JEDEC MS-012, 0.150" Narrow
CD4022BCN	N16E	16-Lead Plastic Dual-In-Line Package (PDIP), JEDEC MS-001, 0.300" Wide

Devices also available in Tape and Reel. Specify by appending the suffix letter "X" to the ordering code.

#### Connection Diagrams

Pin Assignments for DIP, SOIC and SOP  
CD4017B

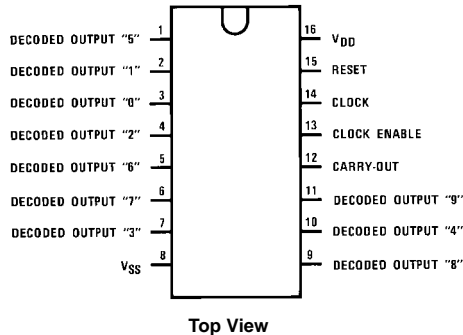

Pin Assignments for DIP and SOIC  
CD4022B

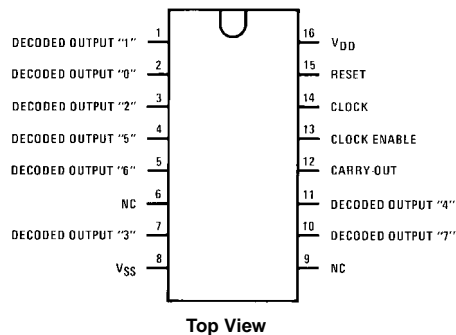



### Absolute Maximum Ratings (Note 1)

(Note 2)

DC Supply Voltage ( $V_{DD}$ )	-0.5 $V_{DC}$ to +18 $V_{DC}$
Input Voltage ( $V_{IN}$ )	-0.5 $V_{DC}$ to $V_{DD}$ +0.5 $V_{DC}$
Storage Temperature ( $T_S$ )	-65°C to +150°C
Power Dissipation ( $P_D$ )	
Dual-In-Line	700 mW
Small Outline	500 mW
Lead Temperature ( $T_L$ )	
(Soldering, 10 seconds)	260°C

### Recommended Operating Conditions (Note 2)

DC Supply Voltage ( $V_{DD}$ )	+3 $V_{DC}$ to +15 $V_{DC}$
Input Voltage ( $V_{IN}$ )	0 to $V_{DD}$ $V_{DC}$
Operating Temperature Range ( $T_A$ )	-40°C to +85°C

**Note 1:** "Absolute Maximum Ratings" are those values beyond which the safety of the device cannot be guaranteed, they are not meant to imply that the devices should be operated at these limits. The table of "Recommended Operating Conditions" and "Electrical Characteristics" provides conditions for actual device operation.

**Note 2:**  $V_{SS} = 0V$  unless otherwise specified.

### DC Electrical Characteristics (Note 2)

Symbol	Parameter	Conditions	-40°C		+25°			+85°C		Units
			Min	Max	Min	Typ	Max	Min	Max	
$I_{DD}$	Quiescent Device Current	$V_{DD} = 5V$		20		0.5	20		150	$\mu A$
		$V_{DD} = 10V$		40		1.0	40		300	$\mu A$
		$V_{DD} = 15V$		80		5.0	80		600	$\mu A$
$V_{OL}$	LOW Level Output Voltage	$ I_{OL}  < 1.0 \mu A$								
		$V_{DD} = 5V$		0.05		0	0.05		0.05	V
		$V_{DD} = 10V$		0.05		0	0.05		0.05	V
		$V_{DD} = 15V$		0.05		0	0.05		0.05	V
$V_{OH}$	HIGH Level Output Voltage	$ I_{OL}  < 1.0 \mu A$								
		$V_{DD} = 5V$	4.95		4.95	5		4.95		V
		$V_{DD} = 10V$	9.95		9.95	10		9.95		V
		$V_{DD} = 15V$	14.95		14.95	15		14.95		V
$V_{IL}$	LOW Level Input Voltage	$ I_{OL}  < 1.0 \mu A$								
		$V_{DD} = 5V, V_O = 0.5V$ or $4.5V$		1.5			1.5		1.5	V
		$V_{DD} = 10V, V_O = 1.0V$ or $9.0V$		3.0			3.0		3.0	V
		$V_{DD} = 15V, V_O = 1.5V$ or $13.5V$		4.0			4.0		4.0	V
$V_{IH}$	HIGH Level Input Voltage	$ I_{OL}  < 1.0 \mu A$								
		$V_{DD} = 5V, V_O = 0.5V$ or $4.5V$	3.5		3.5			3.5		V
		$V_{DD} = 10V, V_O = 1.0V$ or $9.0V$	7.0		7.0			7.0		V
		$V_{DD} = 15V, V_O = 1.5V$ or $13.5V$	11.0		11.0			11.0		V
$I_{OL}$	LOW Level Output Current (Note 3)	$V_{DD} = 5V, V_O = 0.4V$	0.52		0.44	0.88		0.36		mA
		$V_{DD} = 10V, V_O = 0.5V$	1.3		1.1	2.25		0.9		mA
		$V_{DD} = 15V, V_O = 1.5V$	3.6		3.0	8.8		2.4		mA
$I_{OH}$	HIGH Level Output Current (Note 3)	$V_{DD} = 5V, V_O = 4.6V$	-0.2		-0.16	-0.36		-0.12		mA
		$V_{DD} = 10V, V_O = 9.5V$	-0.5		-0.4	-0.9		-0.3		mA
		$V_{DD} = 15V, V_O = 13.5V$	-1.4		-1.2	-3.5		-1.0		mA
$I_{IN}$	Input Current	$V_{DD} = 15V, V_{IN} = 0V$		-0.3		$-10^{-5}$	-0.3		-1.0	$\mu A$
		$V_{DD} = 15V, V_{IN} = 15V$		0.3		$10^{-5}$	0.3		1.0	$\mu A$

**Note 3:**  $I_{OL}$  and  $I_{OH}$  are tested one output at a time.

AC Electrical Characteristics (Note 4)							
T <sub>A</sub> = 25°C, C <sub>L</sub> = 50 pF, R <sub>L</sub> = 200k, t <sub>rCL</sub> and t <sub>fCL</sub> = 20 ns, unless otherwise specified							
Symbol	Parameter	Conditions	Min	Typ	Max	Units	
<b>CLOCK OPERATION</b>							
t <sub>PHL</sub> , t <sub>PLH</sub>	Propagation Delay Time Carry Out Line	V <sub>DD</sub> = 5V		415	800	ns	
		V <sub>DD</sub> = 10V		160	320	ns	
		V <sub>DD</sub> = 15V		130	250	ns	
	Carry Out Line	V <sub>DD</sub> = 5V	C <sub>L</sub> = 15 pF	240	480	ns	
		V <sub>DD</sub> = 10V		85	170	ns	
		V <sub>DD</sub> = 15V		70	140	ns	
	Decode Out Lines	V <sub>DD</sub> = 5V		500	1000	ns	
		V <sub>DD</sub> = 10V		200	400	ns	
		V <sub>DD</sub> = 15V		160	320	ns	
t <sub>TLH</sub> , t <sub>THL</sub>	Transition Time Carry Out and Decode Out Lines	t <sub>TLH</sub>	V <sub>DD</sub> = 5V		200	360	ns
			V <sub>DD</sub> = 10V		100	180	ns
			V <sub>DD</sub> = 15V		80	130	ns
		t <sub>THL</sub>	V <sub>DD</sub> = 5V		100	200	ns
		V <sub>DD</sub> = 10V		50	100	ns	
		V <sub>DD</sub> = 15V		40	80	ns	
f <sub>CL</sub>	Maximum Clock Frequency	V <sub>DD</sub> = 5V	Measured with Respect to Carry Output Line	1.0	2		MHz
		V <sub>DD</sub> = 10V		2.5	5		MHz
		V <sub>DD</sub> = 15V		3.0	6		MHz
t <sub>WL</sub> , t <sub>WH</sub>	Minimum Clock Pulse Width	V <sub>DD</sub> = 5V		125	250	ns	
		V <sub>DD</sub> = 10V		45	90	ns	
		V <sub>DD</sub> = 15V		35	70	ns	
t <sub>rCL</sub> , t <sub>fCL</sub>	Clock Rise and Fall Time	V <sub>DD</sub> = 5V			20	μs	
		V <sub>DD</sub> = 10V			15	μs	
		V <sub>DD</sub> = 15V			5	μs	
t <sub>SU</sub>	Minimum Clock Inhibit Data Setup Time	V <sub>DD</sub> = 5V		120	240	ns	
		V <sub>DD</sub> = 10V		40	80	ns	
		V <sub>DD</sub> = 15V		32	65	ns	
C <sub>IN</sub>	Average Input Capacitance			5	7.5	pF	
<b>Note 4:</b> AC Parameters are guaranteed by DC correlated testing.							
AC Electrical Characteristics (Note 4)							
T <sub>A</sub> = 25°C, C <sub>L</sub> = 50 pF, R <sub>L</sub> = 200k, t <sub>rCL</sub> and t <sub>fCL</sub> = 20 ns, unless otherwise specified							
Symbol	Parameter	Conditions	Min	Typ	Max	Units	
<b>RESET OPERATION</b>							
t <sub>PHL</sub> , t <sub>PLH</sub>	Propagation Delay Time Carry Out Line	V <sub>DD</sub> = 5V		415	800	ns	
		V <sub>DD</sub> = 10V		160	320	ns	
		V <sub>DD</sub> = 15V		130	250	ns	
	Carry Out Line	V <sub>DD</sub> = 5V	C <sub>L</sub> = 15 pF	240	480	ns	
		V <sub>DD</sub> = 10V		85	170	ns	
		V <sub>DD</sub> = 15V		70	140	ns	
Decode Out Lines	V <sub>DD</sub> = 5V		500	1000	ns		
	V <sub>DD</sub> = 10V		200	400	ns		
	V <sub>DD</sub> = 15V		160	320	ns		
t <sub>W</sub>	Minimum Reset Pulse Width	V <sub>DD</sub> = 5V		200	400	ns	
		V <sub>DD</sub> = 10V		70	140	ns	
		V <sub>DD</sub> = 15V		55	110	ns	
t <sub>REM</sub>	Minimum Reset Removal Time	V <sub>DD</sub> = 5V		75	150	ns	
		V <sub>DD</sub> = 10V		30	60	ns	
		V <sub>DD</sub> = 15V		25	50	ns	

### Timing Diagrams

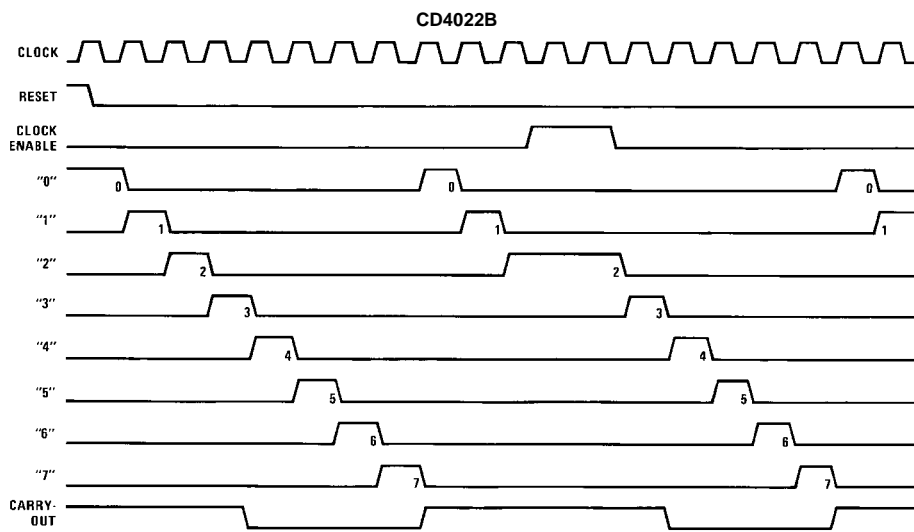
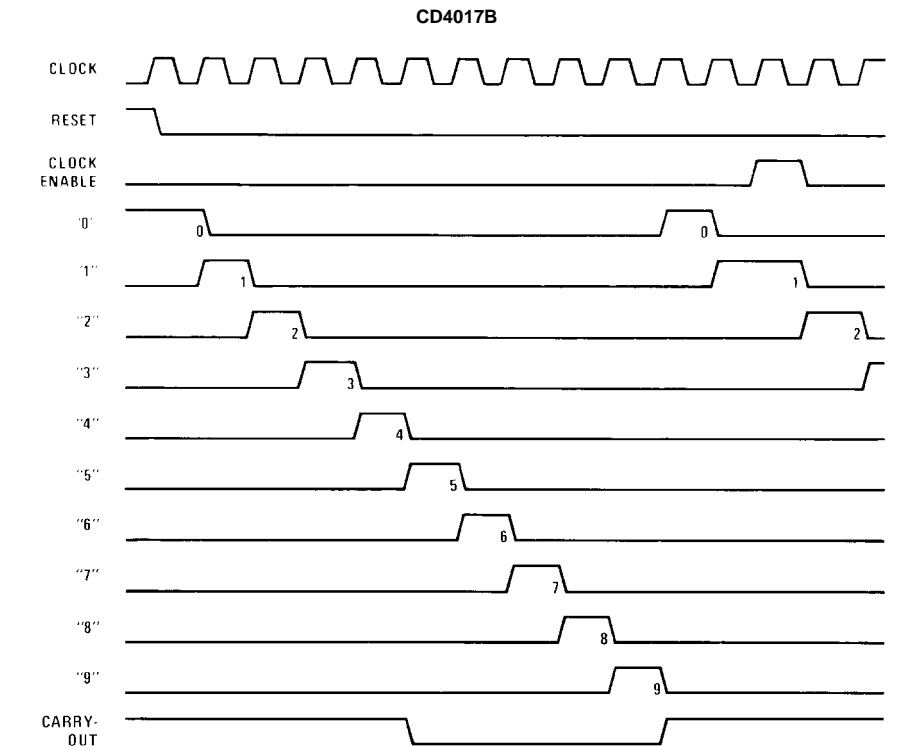

**Physical Dimensions** inches (millimeters) unless otherwise noted

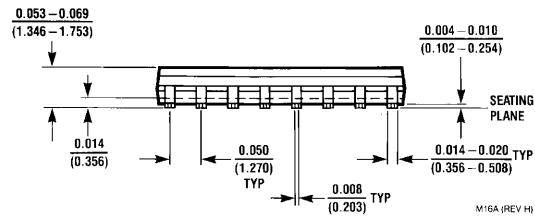
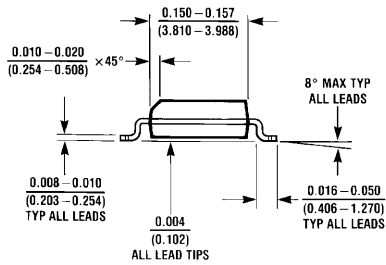
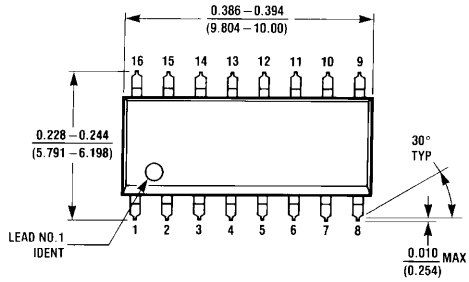

**16-Lead Small Outline Integrated Circuit (SOIC), JEDEC MS-012, 0.150" Narrow  
Package Number M16A**

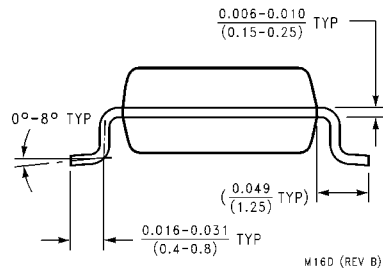
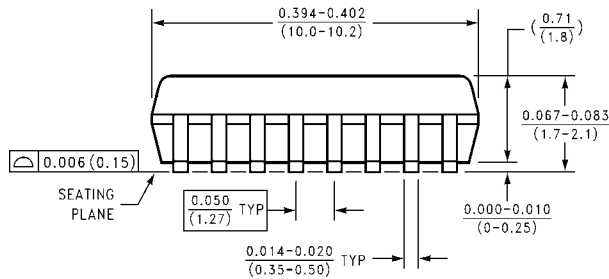
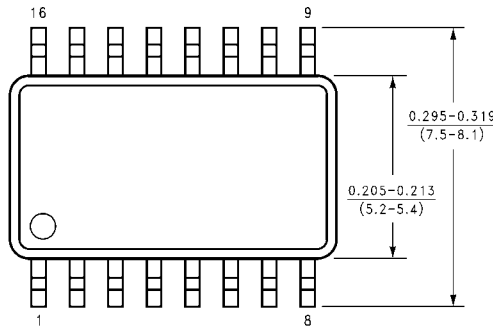

**16-Lead Small Outline Package (SOP), EIAJ TYPE II, 5.3mm Wide  
Package Number M16D**

**Physical Dimensions** inches (millimeters) unless otherwise noted (Continued)

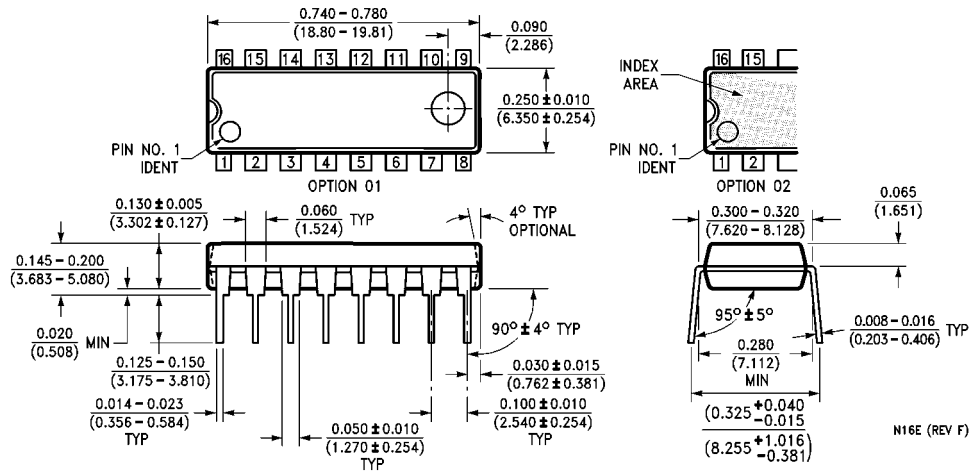

**16-Lead Plastic Dual-In-Line Package (PDIP), JEDEC MS-1, 0.300" Wide  
Package Number N16E**

**LIFE SUPPORT POLICY**

FAIRCHILD'S PRODUCTS ARE NOT AUTHORIZED FOR USE AS CRITICAL COMPONENTS IN LIFE SUPPORT DEVICES OR SYSTEMS WITHOUT THE EXPRESS WRITTEN APPROVAL OF THE PRESIDENT OF FAIRCHILD SEMICONDUCTOR CORPORATION. As used herein:

1. Life support devices or systems are devices or systems which, (a) are intended for surgical implant into the body, or (b) support or sustain life, and (c) whose failure to perform when properly used in accordance with instructions for use provided in the labeling, can be reasonably expected to result in a significant injury to the user.
2. A critical component in any component of a life support device or system whose failure to perform can be reasonably expected to cause the failure of the life support device or system, or to affect its safety or effectiveness.

[www.fairchildsemi.com](http://www.fairchildsemi.com)

Copyright © Each Manufacturing Company.

All Datasheets cannot be modified without permission.

This datasheet has been download from :

[www.AllDataSheet.com](http://www.AllDataSheet.com)

100% Free DataSheet Search Site.

Free Download.

No Register.

Fast Search System.

[www.AllDataSheet.com](http://www.AllDataSheet.com)