

# LIR18650 Lithium Ion Battery

## Brief Datasheet

### 1 Dimension

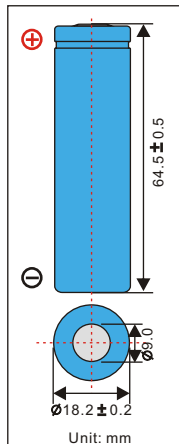

### 3 Electrical Characteristics

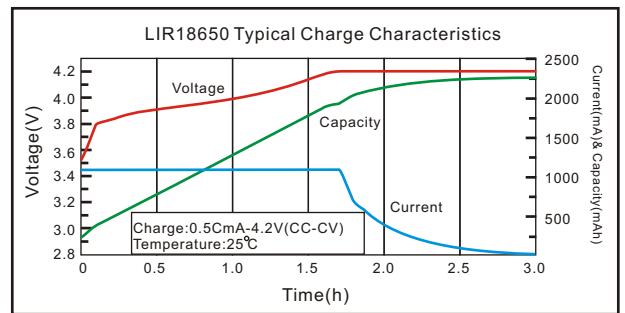

### 2 Basic Specification

Nominal Voltage	3.7V	
Nominal Capacity	Typical	2200mAh (0.2C discharge)
	Minimum	2150mAh (0.2C discharge)
Charge method	CC/CV (Constant Current-Constant Voltage) current: 0.5C Voltage: 4.2V End current: 20mA	
Charging Voltage	4.20V±0.05V	
Charging Std. Current	1100mA	
Max Current	Charge	1760mA
	Discharge	2C
Ambient Temperature	Std. Charge	-20°C to 45°C
	Discharge	-20°C to 60°C
	Storage	-5°C to 35°C
Discharge cut-off voltage	2.75V	
Internal Impedance	<80mΩ	
Cycle life	>300cycles(≥80% capacity)	
Nominal Weight	Approx.47g	

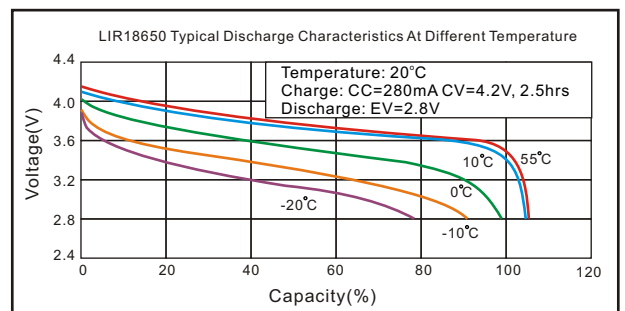
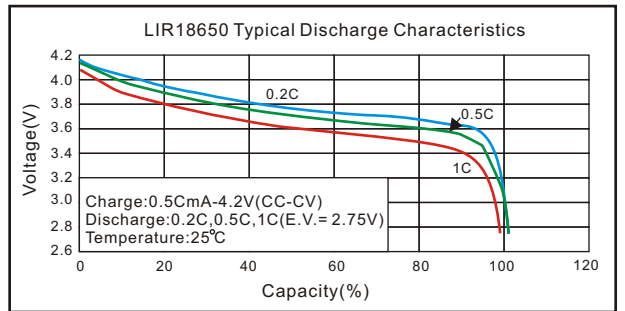

Note: \*1C = 1 Capacity

# Li-ion

Note: Any representations in this brochure concerning performance, are for informational purposes only and are not construed as warranties either expressed or implied, of future performance.

1

2

3

4

### -VX Pin

### -VXR Pin

A

A

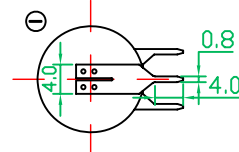
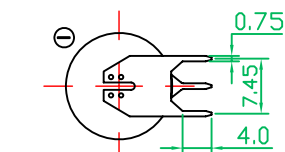

B

B

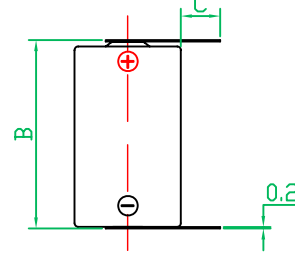
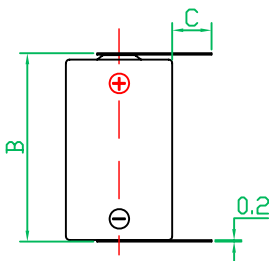

C

C

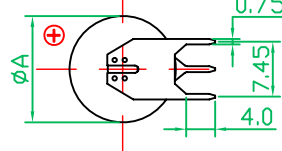
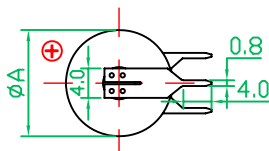

### -VB Pin

### -VBR Pin

D

D

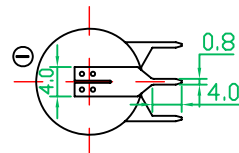
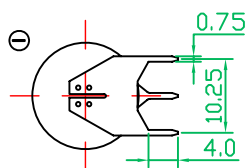

E

E

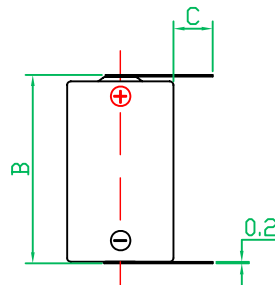
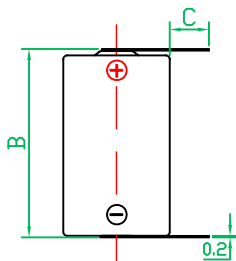

F

F

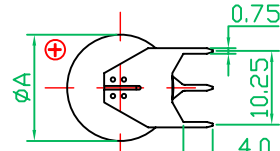
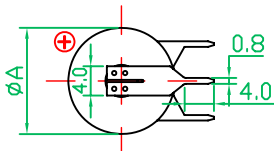

1

2

3

4

1

2

3

4

### -VY Pin

### -FT Pin

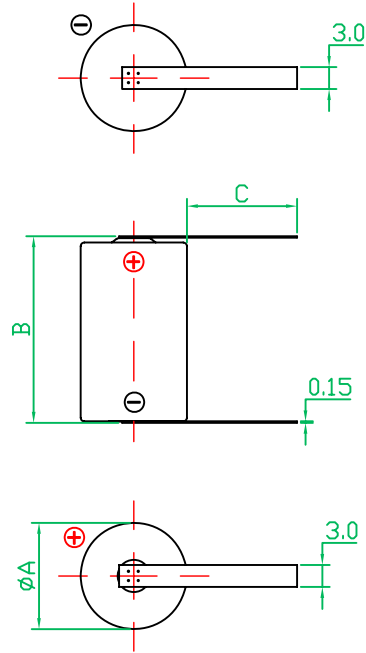
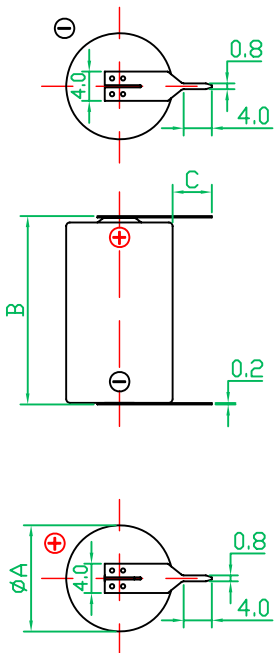

### -AV(Axial Pin)

### -AX(Axial Pin)

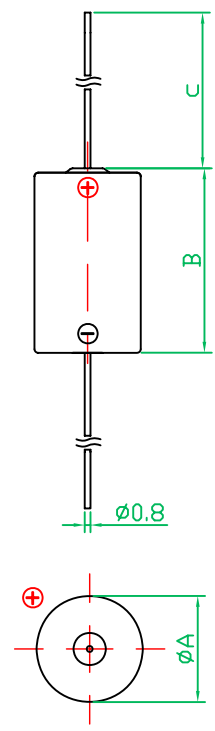
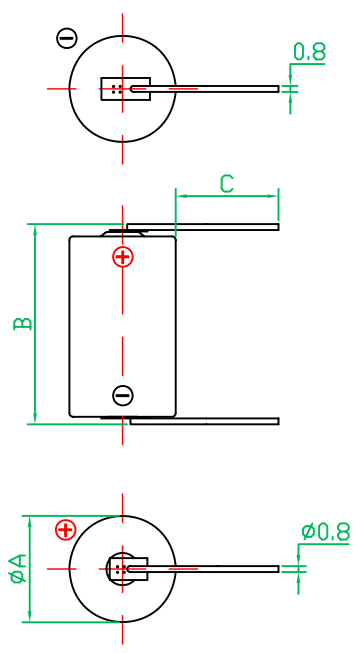

1

2

3

4

A

A

B

B

C

C

D

D

E

E

F

F

1

2

3

4

# - LD(Cable)

# - LD/(With connector)

A

A

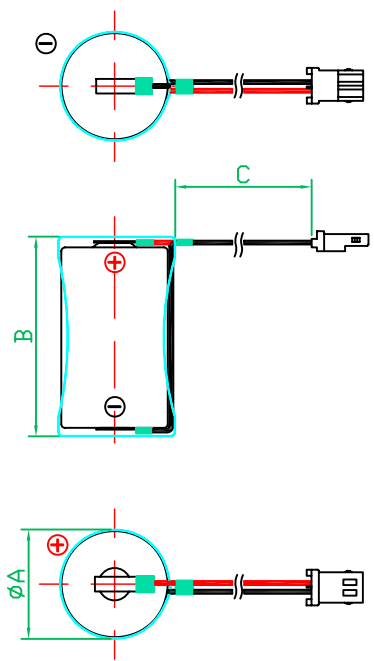
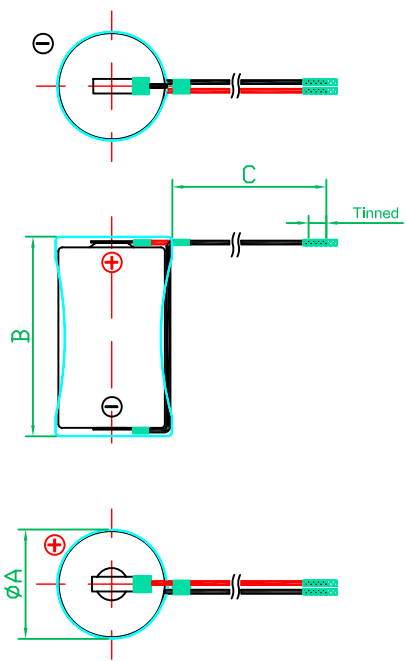

B

B

C

C

1

2

3

4