

REVISION RECORD

REV	ECN	DESCRIPTION	DRFT	DATE
△1		图面更新	HW	05/04/06*
△2		变更焊脚材质	CSX	07/05/07*
△3		品名、料号增加环保标示“(H)”	LJH	12/08/07*
△4		增加UL、CE刻字	CSX	02/25/08*
△5	09-0025	改善夹线,产品加胶,测试孔外移	CW	08/28/09*
△6	09-0084	增加VDE刻字及参数	Zengy	10/14/09*
△7	15-0243	变更焊脚/按钮料号,依实物修改图面	NPX	06/24/15*

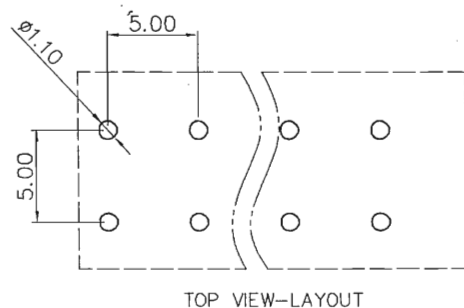
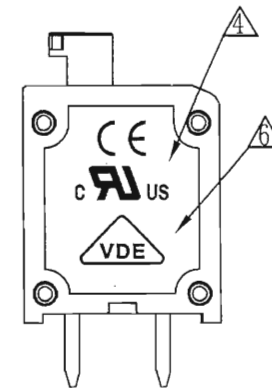
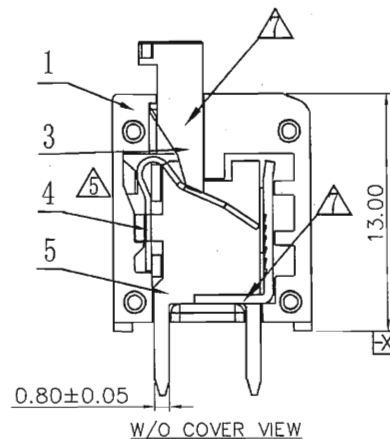
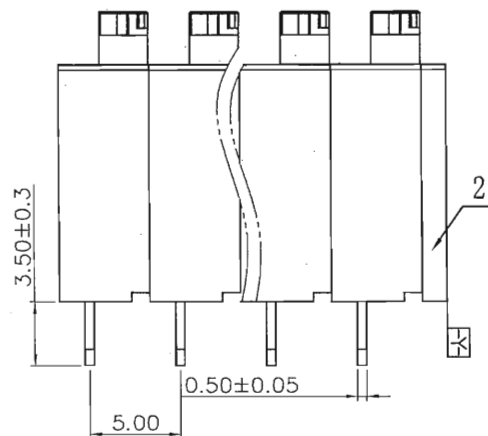
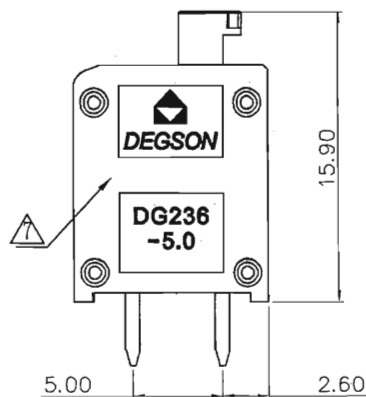
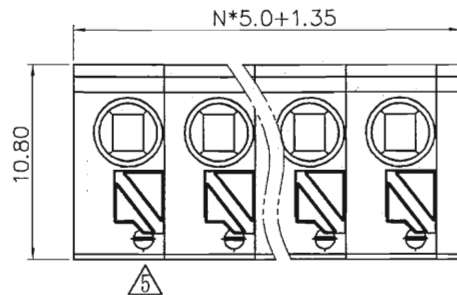

- NOTES:
- 1.DIMENSION SHALL BE INTERPRETED PER ASME Y14.5-2009.
 - 2.PITCH: 5.0MM,POLES: N=XXP
 - 3.RATED VOLTAGE/CURRENT: UL 300V/8A
VDE 400V/10A
 - 4.OPERATION TEMPERATURES: -40℃~+105℃
 - 5.WITHSTANDING VOLTAGE: AC2500V/1MIN
 - 6.INSULATION RESISTANCE: 5000MΩ/DC1000V
 - 7.WIRE RANGE: 20~16AWG,1.5MM²
 - 8.UNDIMENSIONED TOLERANCES:

PITCH RANGE IN MM	NOMINAL DIMENSION RANGE IN MM						-		
	TO 6	OVER 6 TO 10	OVER 10 TO 24	TO 30	OVER 30 TO 60	OVER 60 TO 100		OVER 100 TO 150	
	±0.10	±0.15	±0.25	±0.20	±0.30	±0.50	±0.70	±1.00	0.05/10

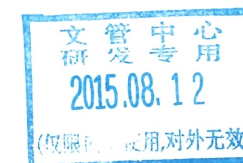

ITEM	NAME OF PART	NO. OF PART	Q'TY	MATERIAL	NOTES
5	DG236-5.0 Pin header	△ 3020B00030(H)	XX	Pure copper	Sn plated
4	DG236-5.0 Spring	X000000590(H)	XX	Stainless Steel	
3	DG236-5.0 Button	△ 3020DYY01C(H)	XX	PA66	
2	DG236-5.0 Cover	3020CYY01A(H)	1	PA66	UL94V-0
1	DG236-5.0-Housing	3020AYY01A(H)	XX	PA66	UL94V-0

MM (INCH)		MATERIAL:	宁波高正电子有限公司	
TOLERANCES EXCEPT AS NOTED		FINISH:	DEGSON® DEGSON ELECTRONICS CO., LTD.	
.X ±	.X' ±	PART NO.:	NAME: DG236-5.0-XXP-1Y-00A(H)	
.XX ±	.XX' ±	APPD: Aaron 7/3-15	TITLE: ASSEMBLY DRAWING	REV T7
.XXX ±	.XXX' ±	CHKD: Penny 7/1-15	DRAWING NO.: DG236-5.0-E01	
ANGLES ± 1'		DRFT:ExpAnyl/30/04'	DO NOT SCALE DRAWING	SCALE 1:1 SHEET 1/1
THIRD ANGLE PROJECTION				