

AT91EB40A Evaluation Board

User Guide



Table of Contents

Section 1

Overview.....	1-1
1.1 Scope.....	1-1
1.2 Deliverables.....	1-1
1.3 The AT91EB40A Evaluation Board.....	1-2

Section 2

Setting Up the AT91EB40A Evaluation Board.....	2-1
2.1 Electrostatic Warning.....	2-1
2.2 Requirements.....	2-1
2.3 Layout.....	2-1
2.4 Jumper Settings.....	2-2
2.5 Powering Up the Board.....	2-2
2.6 Measuring Current Consumption on the AT91R40008.....	2-2

Section 3

The On-board Software.....	3-1
3.1 The AT91EB40A Evaluation Board.....	3-1
3.2 Boot Software Program.....	3-1
3.3 Programmed Default Memory Mapping.....	3-2
3.4 Flash Uploader.....	3-2
3.5 Angel Monitor.....	3-3

Section 4

Circuit Description.....	4-1
4.1 AT91R40008 Processor.....	4-1
4.2 Expansion Connectors.....	4-1
4.3 Memories.....	4-1
4.4 Power and Crystal Quartz.....	4-2
4.5 Push-buttons, LEDs and Serial Interfaces.....	4-2
4.6 Reset Circuit and JTAG Interface.....	4-2
4.7 Layout Drawing.....	4-3

Section 5

Appendix A – Configuration Straps.....	5-1
5.1 Configuration Straps.....	5-1
5.2 Power Consumption Measurement Straps (JP5A/B, JP7A/B).....	5-3
5.3 Ground Links (JP6).....	5-3
5.4 Increasing Memory Size.....	5-4

Section 6
Appendix B – Schematics 6-1
 6.1 Schematics 6-1

Section 7
Appendix C – Bill of Materials 7-1

Section 8
Appendix D – Flash Memory Mapping 8-1





Section 1

Overview

-
- 1.1 Scope**
- The AT91EB40A Evaluation Board enables real-time code development and evaluation. It supports the AT91R40008.
- This guide focuses on the AT91EB40A Evaluation Board as an evaluation and demonstration platform:
- Section 1 provides an overview.
 - Section 2 describes how to set up the evaluation board.
 - Section 3 details the on-board software.
 - Section 4 contains a description of the circuit board.
 - Section 5 describes the configuration straps.
 - Section 6 shows board schematics.
 - Section 7 is the bill of materials for the EB40A.
 - Section 8 presents the memory mapping of the on-board software.
-
- 1.2 Deliverables**
- The evaluation board is delivered with a DB9 plug-to-DB9 socket straight-through serial cable to connect the target evaluation board to a PC. A bare power lead with a 2.1 mm jack on one end for connection to a bench power supply is also delivered.
- The evaluation board is also delivered with several CD-ROMs:
- The AT91 CD-ROM contains summary and full datasheets, datasheets with electrical and mechanical characteristics, application notes and Getting Started documents for all evaluation boards and AT91 microcontrollers. An AT91 C Library with project examples is also provided. This allows the user to begin evaluating the AT91 ARM Thumb 32-bit microcontroller quickly.
 - Third-party evaluation version of Development and Debugging Tools (compiler, assembler, linker, debugger). Note that evaluation version CD-ROMs from third-party suppliers are subject to change.
- The evaluation board is capable of supporting different kinds of debugging systems, using an ICE interface or the on-board Angel™ Debug Monitor.

1.3

The AT91EB40A Evaluation Board

The board consists of an AT91R40008 together with several peripherals:

- Two serial ports
- Reset push button
- An indicator that memorizes a reset appearance
- Four user-defined push buttons
- Eight LEDs
- A footprint of a 256-KB 16-bit SRAM (upgradeable to 1M byte)
- 2-MB 16-bit Flash (of which 1M byte is available for user software)
- A footprint of an extra Flash memory
- 2 x 32-pin EBI expansion connectors
- 2 x 32-pin I/O expansion connectors
- 20-pin JTAG interface connector

If required, user-defined peripherals can also be added to the board. See Section 5 for details.



Figure 1-1. AT91EB40A Evaluation Board Block Diagram

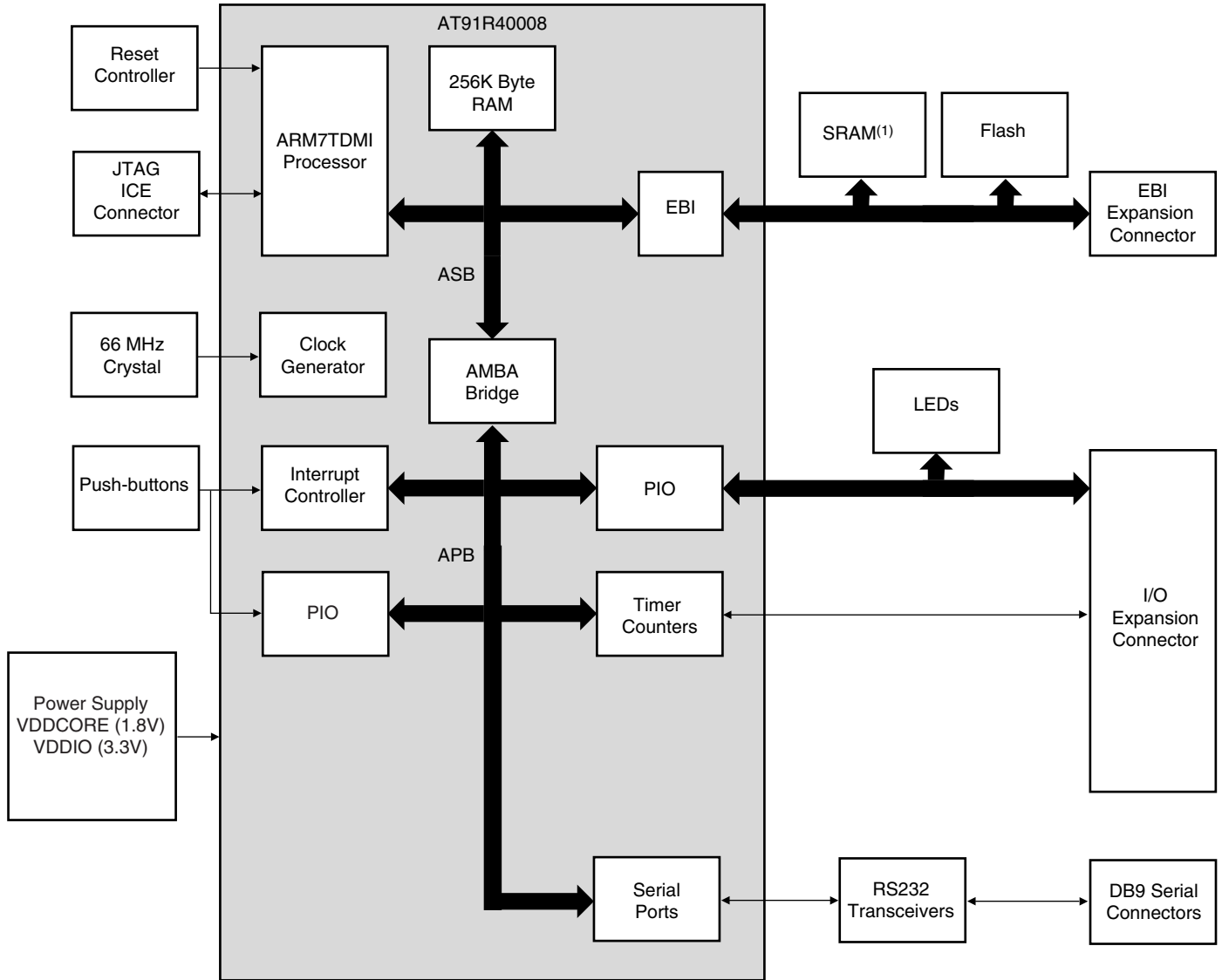

Note: No external SRAM is fitted on the board. See section “Memories” on page 4-1 for more details.



-
- 2.4 Jumper Settings** JP1 is used to boot standard or user programs. For standard operations, set it in the STD position; for user programs, set it to the USER position.
CB2 is used to select the core power supply between 1.8V and 3.3V.
For more information on the CB2 setting, see “Configuration Straps” on page 5-1 in Section 5.

-
- 2.5 Powering Up the Board** DC power is supplied to the board via the 2.1 mm socket (J1) shown in Figure 2-2. The polarity of the power supply is not critical. The minimum voltage required is 7V.

Figure 2-2. 2.1 mm Socket

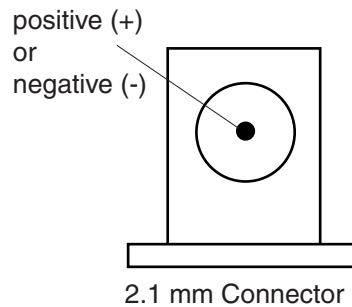

The board has a voltage regulator providing +3.3V and 1.8V. The regulator allows the input voltage to range from 7V to 9V. When you switch the power on, the red LED D11 marked PWR lights up. If it does not, switch off and check the power supply connections.

-
- 2.6 Measuring Current Consumption on the AT91R40008** The board is designed to generate the power for the AT91 product, and only the AT91 product, through the jumpers JP5A/JP5B (V_{DDIO}) and JP7A/JP7B (V_{DDCORE}). This feature enables the current consumption of the AT91 product to be measured.
See “Power Consumption Measurement Straps (JP5A/B, JP7A/B)” on page 5-3 in Section 5 for further details.

2.7

Testing the AT91EB40A Evaluation Board

To test the AT91EB40A Evaluation Board, perform the following procedure:

1. Hold down the SW1 button and power-up the board, or generate a reset and wait for the light sequence on each LED to complete. All the LEDs light.
2. Release the SW1 button. The LEDs D1 to D5 light up in sequential order. If all the LEDs light up twice, this indicates an error. Note that LEDs D6 to D8 are reserved for future use.

The LEDs represent the following test functions:

- D1 for the internal SRAM
- D2 for the external SRAM⁽¹⁾
- D3 for the external Flash
- D5 for the USART
- D6 reserved
- D7 reserved
- D8 reserved

During a complete test cycle, each LED flashes once to inform the user that the corresponding function has been successfully tested. If an error is detected, all the LEDs will light up twice. After a complete test cycle, the embedded self-test software called FTS (Functional Test Software) restarts a new cycle.

Note: 1. At factory, no external SRAM is mounted on the board. The test shows an error. If the user upgrades the board with external SRAM, the test runs normally.





Section 3

The On-board Software

3.1 The AT91EB40A Evaluation Board

The AT91EB40A Evaluation Board embeds an AT49BV1604 or AT49BV1614 Flash memory device programmed with default software.

When delivered, the Flash memory device contains:

- the Boot Software Program
- the Functional Test Software (FTS)
- the Flash uploader
- the Angel Debug Monitor
- a default user boot with a default application (LED Swing Application)

The boot software program, functional test software (FTS), and the Flash downloader are in sectors 0 and 1 of the Flash device. Sectors 3 to 8 support the Angel Debug Monitor. The default user boot with a default application is located in sector 24.

These sectors are not locked in order to provide an easy on-board upgrade. The user must avoid overwriting these sectors. The remaining sectors are user definable, and can be programmed using one of the Flash downloader "Flash_16x4" solutions offered in the AT91 library. See "Appendix D – Flash Memory Mapping" on page 8-1 for further details.

3.2 Boot Software Program

The boot software program configures the AT91R40008, and thus controls the memory and other board components.

The boot software program is started at reset if JP1 is in the STD position. If JP1 is in the USER position, the AT91R40008 boots from address 0x01100000 in the Flash, which must have a user-defined boot.

The boot software program first initializes the EBI, then executes the REMAP procedure and, finally, checks the state of the buttons as described below.

- When the SW1 button is pressed:
 - All the LEDs light up together.
 - The D1 LED remains lit when SW1 is released.
 - The Functional Test Software (FTS) is started.
- The SW2 button is reserved.

- When the SW3 button is pressed:
 - All the LEDs light up together.
 - The D3 LED remains lit when SW3 is released.
 - The Flash uploader is activated.
- The SW4 button is reserved for future use.
- When no buttons are pressed:
 - Branch at address 0x01006000.
 - The Angel Debug Monitor starts from this address by recopying itself in internal SRAM.

3.3 Programmed Default Memory Mapping

Table 3-1 defines the mapping defined by the boot program.

Table 3-1. Memory Map

Part Name	Start Address	End Address	Size	Device
U1A	0x01000000	0x011FFFFFFF	2M Bytes	Flash AT49BV162A
U2 - U3 ⁽¹⁾	0x02000000	0x0203FFFF	256K Bytes	SRAM

Note: 1. If fitted on the board

U1A is divided in two parts. This is done by the jumper JP1. In the upper part, the first sector (sector 24) at address 0x01100000 must be programmed with a boot sequence to be debugged. This sector can be mapped at address 0x01000000 (or 0x0 after a reset) when the jumper JP1 is in the USER position. See “Appendix A – Configuration Straps” on page 5-1.

3.4 Flash Uploader

The Flash Uploader included in the EB40A Boot software is the same Flash Uploader factory-programmed in the Flash-based AT91 devices, the AT91FR4042 and the AT91FR40162/S. The Flash Uploader allows programming to the Sector 24 of Flash through a serial port. Either of the on-chip USARTs can be used by the Flash Uploader.

To boot from the application downloaded in the Sector 24, the downloading address must be 0x01100000. Other sectors in plane B can be used to store constant data. The boot starts the Flash Uploader if the SW3 button is pressed at reset.

The procedure is as follows:

1. Connect the Serial A (or B⁽¹⁾) port of the AT91EB40A Evaluation Board to a host PC Serial Port using the straight serial cable provided.
2. Start the AT91Loader.exe program available in the AT91 Library on the host computer. The AT91 Loader must be configured beforehand. For more details, see the documentation regarding the free Host Loader available for download on the Atmel web site.
3. Check JP1 is in STD position. Power-on or press RESET, holding down the SW3 button simultaneously. Wait for all LEDs to light up together and then release SW3. LED3 remains lit. If the AT91Loader is configured in automatic mode, the download starts. Wait for the download to end.

4. Put JP1 in USER position and press the reset button. The application downloaded starts.

Note: 1. For the Serial B port, use a female/female straight serial cable.

3.5 Angel Monitor

The Angel Monitor is located in the Flash from 0x01006000 up to 0x01011FFF. The boot program starts it if no button is pressed at reset.

When Angel starts, it recopies itself in internal SRAM in order to run faster. The internal SRAM used by Angel is from 0x00020000 to 0x0003FFFF, i.e., the highest half part of the internal SRAM.

The Angel on the AT91EB40A Evaluation Board can be upgraded regardless of the version programmed on it.

Note that if the debugger is started through ICE while the Angel monitor is on, the Advanced Interrupt Controller (AIC) and the USART channel are enabled.





Section 4

Circuit Description

-
- 4.1 AT91R40008 Processor** Figure 6-1 in Section 6, “Appendix B – Schematics” shows the AT91R40008. The footprint is for a 100-pin TQFP package.
- Jumper JP5A/JP5B (see Figure 6-7 in Section 6, “Appendix B – Schematics”) can be removed by the user to allow measurement of the current on V_{DDIO} . Jumper JP7A/JP7B can be removed to measure the core microcontroller consumption on V_{DDCORE} .
-
- 4.2 Expansion Connectors** The two expansion connectors, I/O expansion connector and EBI expansion connector, and the JTAG interface are described below.
- The I/O and EBI expansion connectors’ pinout and position are compatible with other AT91 evaluation boards (except the I/O expansion connector pinout and position of the EB40) so that users can connect their prototype daughter boards to any of these evaluation boards.
- 4.2.1 I/O Expansion Connector** The I/O expansion connector P2 makes the general-purpose I/O (GPIO) lines, VCC3V3 and Ground, available to the user. Configuration straps are used to select between the I/O lines being used by the evaluation board or by the user via the I/O expansion connector. The connector fitted at the factory is a 32 x 2 connector on a 0.1” (2.54 mm) pitch.
- 4.2.2 EBI Expansion Connector** The EBI expansion connector P1 makes the data bus, address bus, chip select, read/write signals, oscillator output, wait request pins, VCC3V3 and Ground available to the user. The connector fitted at the factory is a 32 x 2 connector on a 0.1” (2.54 mm) pitch.
-
- 4.3 Memories** The schematic (Figure 6-2 on page 6-3 in Section 6, “Appendix B – Schematics”) shows two 128K/512K x 8 SRAM devices that can be added to the AT91EB40A.
- Note:** The AT91EB40A evaluation board does not feature any external SRAM. The user can add SRAM ranging in size from 256K bytes x 16 bits to 1M byte x 16 bits. See “Increasing Memory Size” on page 5-4 for SRAM references.
- Figure 6-8 on page 6-9 shows the Flash memories. The printed circuit board of the EB40A provides two footprints (U1A and U1B) for two different Flash memories. At factory, the EB40A fits an AT49BV162A Flash memory (U1A). U1A footprint can also accept an AT49BV161 Flash memory. An extra Flash memory can be added on U1B footprint. The U1B footprint can accept an AT49BV8011 or an AT49BV400 Flash memory. The Flash memory on U1A and the Flash memory on U1B cannot be used at the

same time (i.e., one as a boot memory and the other as data storage memory). In fact, the AT91 NCS0 chip select line is connected to U1A or U1B chip select line according to the position of CB11. See “Appendix A – Configuration Straps” and Figure 6-8 in “Appendix B – Schematics” .

4.4 Power and Crystal Quartz

The system clock is derived from a single 66 MHz crystal oscillator. An external clock can be input on the EB40A via the EBI connector on pin B4 - EBI_MCKI. See Figure 6-6 in “Appendix B – Schematics” .

The voltage regulator U9 provides 3.3V to VDDIO and to all other devices of the board. The voltage regulator U11 provides 1.8V for VDDCORE of the AT91R40008.

Power can be applied via the 2.1mm connector to the regulator in either polarity because of the diode-rectifying circuit.

4.5 Push-buttons, LEDs and Serial Interfaces

4.5.1 Push-buttons and LEDs

Figure 6-3 in “Appendix B – Schematics” shows push buttons and LEDs. SW1, SW2, SW3 and SW4 push buttons are debounced, buffered and connected to P12/FIQ, P9/IRQ0, P1/TIOA0 and P2/TIOB0, respectively. The eight general-purpose LEDs are connected to PIO (P15 to P19 and P3 to P6).

4.5.2 Serial Interface

Two 9-way D-type connectors (P3/P4) are provided for serial port connection.

Serial port A (P3) is used primarily for Host PC communication and is a DB9 female connector. TXD and RXD are swapped, so that a straight-through cable can be used. CTS and RTS are connected together, as is DCD, DSR and DTR.

Serial port B (P4) is a DB9 male connector with TXD and RXD in conformance with the standard RS-232 pinout. Apart from TXD, RXD and ground, the other pins are not connected.

A MAX3223 device (U10) and associated bulk storage capacitors provide RS-232 level conversion.

4.6 Reset Circuit and JTAG Interface

4.6.1 Reset Circuit

A supervisory circuit has been included in the design to detect and consequently reset the board when the 3.3V supply voltage drops below 2.7V. Note that this voltage can be changed depending on the board production series. The supervisory circuit also provides a debounced reset signal. This device also generates the reset signal in case of watchdog timeout, as the pin NWDOVF of the AT91R40008 is connected on its input /MR.

The assertion of this reset signal lights the red RESET LED (D10). By pressing the CLEAR RESET push button (S2), the LED is turned off.



4.6.2 JTAG Interface An ARM-standard 20-pin box header (P5) is provided to enable connection of an ICE to the JTAG inputs on the AT91. This allows code to be debugged on the board without using system resources, such as memory and serial ports.

4.7 Layout Drawing The layout diagram (Figure 6-1 on page 6-2 in Section 6, “Appendix B – Schematics”) shows an approximate floorplan for the board. This has been designed to give the lowest board area, while still providing access to all test points, jumpers and switches on the board.

The board is provided with four mounting holes, one at each corner, into which feet are attached. The board has two signal layers and two power planes.





Section 5

Appendix A – Configuration Straps

5.1 Configuration Straps

By using the I/O and EBI expansion connectors, users can connect their own peripherals to the evaluation board. These peripherals may require more I/O lines than available while the board is in its default state. Extra I/O lines can be made available by disabling some of the on-board peripherals or features. This is done using the configuration straps detailed below. Some of these straps present a default wire (notified by the default mention) that must be cut before soldering the strap.

CB1	On-board CS4 Signal
Closed ⁽¹⁾	AT91 CS4 signal is connected to the EBI expansion connector (P1-B21).
Open	AT91 CS4 signal is not connected to the EBI expansion connector (P1-B21). This authorizes users to connect the EBI expansion connector of this board to the MPI expansion connector of an AT91EB63 Evaluation Board without conflict problems.

CB2 ⁽²⁾	Core Power Supply Selection
1 - 2	The AT91 core is powered by 3.3V power supply. NOT ALLOWED for the AT91R40008.
2 - 3	The AT91 core is powered by 1.8V power supply.

CB3	On-board Boot Chip Select
Closed ⁽¹⁾	AT91 NCS0 select signal is connected to the Flash memory (U1A or U1B). See also CB11.
Open	AT91 NCS0 select signal is not connected to the Flash memory. This authorizes users to connect the corresponding chip select signal to their own resources via the EBI Expansion Connector.

CB4	Flash Reset (U1A)
Closed ⁽¹⁾	The on-board reset signal NRST is connected to the Flash NRESET input.
Open	The on-board reset signal NRST is not connected to the Flash NRESET input.

CB5	Flash RDY/BUSY Pin (U1A)
Closed ⁽¹⁾	The RDY/BUSY line of the Flash memory is connected to P10/IRQ1 pin.
Open	The RDY/BUSY line of the Flash memory is not connected to P10/IRQ1 pin.

CB6	Push-button Enabling
Open ⁽¹⁾	SW1 to SW4 inputs to the AT91 are valid.
Closed	SW1 to SW4 inputs to the AT91 are not valid. This authorizes users to connect the corresponding PIO to their own resources via the I/O Expansion Connector.

CB9	AT91 Master Clock Input
1 - 2	AT91 Master Clock input (MCKI) is connected to the on-board 66 MHz oscillator.
2 - 3	AT91 Master Clock input (MCKI) is connected to the EBI_MCKI (B4) pin of the EBI expansion connector. This authorizes the user to input an external clock to the AT91.

CB10	Ground Link
Closed	The electrical ground is connected to mechanical ground.
Open ⁽¹⁾	The electrical ground is not connected to mechanical ground.

CB11	On-board Flash Memory Selection
1 - 2	AT91 NCS0 select signal is connected to the Flash device U1A.
2 - 3	AT91 NCS0 select signal is connected to the Flash device U1B.

CB12	Flash Reset (U1B)
Closed ⁽¹⁾	The on-board reset signal is connected to the Flash NRESET input.
Open	The on-board reset signal is not connected to the Flash NRESET input.

CB15	Flash RDY/BUSY Pin (U1B)
Closed ⁽¹⁾	The RDY/BUSY line of the Flash memory is connected to P10/IRQ1 pin.
Open	The RDY/BUSY line of the Flash memory is not connected to P10/IRQ1 pin.



CB16	Highest Address Bit
Open ⁽¹⁾	Setting to support an AT49BV1604 or AT49BV1614 (or an AT49BV161) on U1A footprint or an AT49BV8011 (or an AT49BV400) on U1B footprint.
Closed	Setting to support an AT49BV1604/A on U1A footprint.

JP1	User or Standard Boot Selection
2-3	The first half of the Flash memory is accessible at its base address.
1-2	The second half of the Flash memory is accessible at its base address. This authorizes users to download their own application software in this part and to boot on it.

- Notes:
1. Hardwired default position: To cancel this default configuration, the user should first cut the wire on the board.
 2. Regarding CB2 setting: The EB40A also supports an AT91M40800 or an AT91R40807. However, if the user wants to evaluate these devices, the microcontroller U7 and the oscillator Y1 must be changed. If an AT91M40800 is mounted on the board, external SRAM must be added to increase SRAM quantity since the AT91M40800 embeds 8K bytes only.
To upgrade the EB40A to support an AT91M40800 or an AT91R40807:
 1. De-solder the microcontroller U7.
 2. Solder the AT91M40800 or the AT91R40807 to the U7 footprint.
 3. De-solder the crystal oscillator Y1.
 4. Solder a crystal oscillator (up to 40 MHz) to the Y1 footprint.
 5. Set CB2 to 1 - 2 before supplying the board.

-
- 5.2 Power Consumption Measurement Straps (JP5A/B, JP7A/B)**
- The JP5A/B straps enable connection of an ammeter to measure the AT91R40008 global consumption on VDDIO.
- The JP7A/B straps enable connection of an ammeter to measure the AT91R40008 global consumption on VDDCORE.
-
- 5.3 Ground Links (JP6)**
- The CB10 strap allows the user to connect the electrical and mechanical grounds.

5.4 Increasing Memory Size

The AT91EB40A Evaluation Board is not supplied with external SRAM devices. If, however, the user needs more than 256K bytes of internal memory embedded in the AT91R40008, SRAM from 256K bytes to 1M bytes may be added.

The following references for the 128K x 8 SRAM are available:

Manufacturer	Reference
Samsung	U2 - U3 footprint: KM68V1002BJ-10 in 32-SOJ-400 package U4 - U5 footprint: KM68V1002BJ-10 in 32-TSOP2-400F package
IDT	U2 - U3 footprint: 71V124-S10Y in 400-mil SOJ package (SO32-3) U4 - U5 footprint: 71V124-S10PH in TSOP Type II (SO32-4)

The following references for the 512K x 8 SRAM are available:

Manufacturer	Reference
Samsung	U2 - U3 footprint: KM68V4002BJ-10 in 36-SOJ-400 package U4 - U5 footprint: KM68V4002BJ-10 in 36-TSOP2-400F package
IDT	U2 - U3 footprint: 71V424-S10Y in 36-pin 400-mil SOJ package U4 - U5 footprint: 71V124-S10PH in 44-pin TSOP Type II



Section 6

Appendix B – Schematics

6.1 Schematics

The following schematics are appended:

- Figure 6-1. PCB Layout
- Figure 6-2. SRAM Memory Devices and Two-wire Interface Memory
- Figure 6-3. Push Buttons, LEDs and Serial Interface
- Figure 6-4. Reset and JTAG Interface
- Figure 6-5. AT91R40008
- Figure 6-6. I/O and EBI Expansion Connectors
- Figure 6-7. Power Supply
- Figure 6-8. Flash Memory Devices

The pin connectors are indicated on the schematics:

- P1 = EBI Expansion Connector (Figure 6-6)
- P2 = I/O Expansion Connector (Figure 6-6)
- P3 = Serial A (Figure 6-3)
- P4 = Serial B (Figure 6-3)
- P5 = JTAG Interface (Figure 6-4)

Figure 6-1. PCB Layout

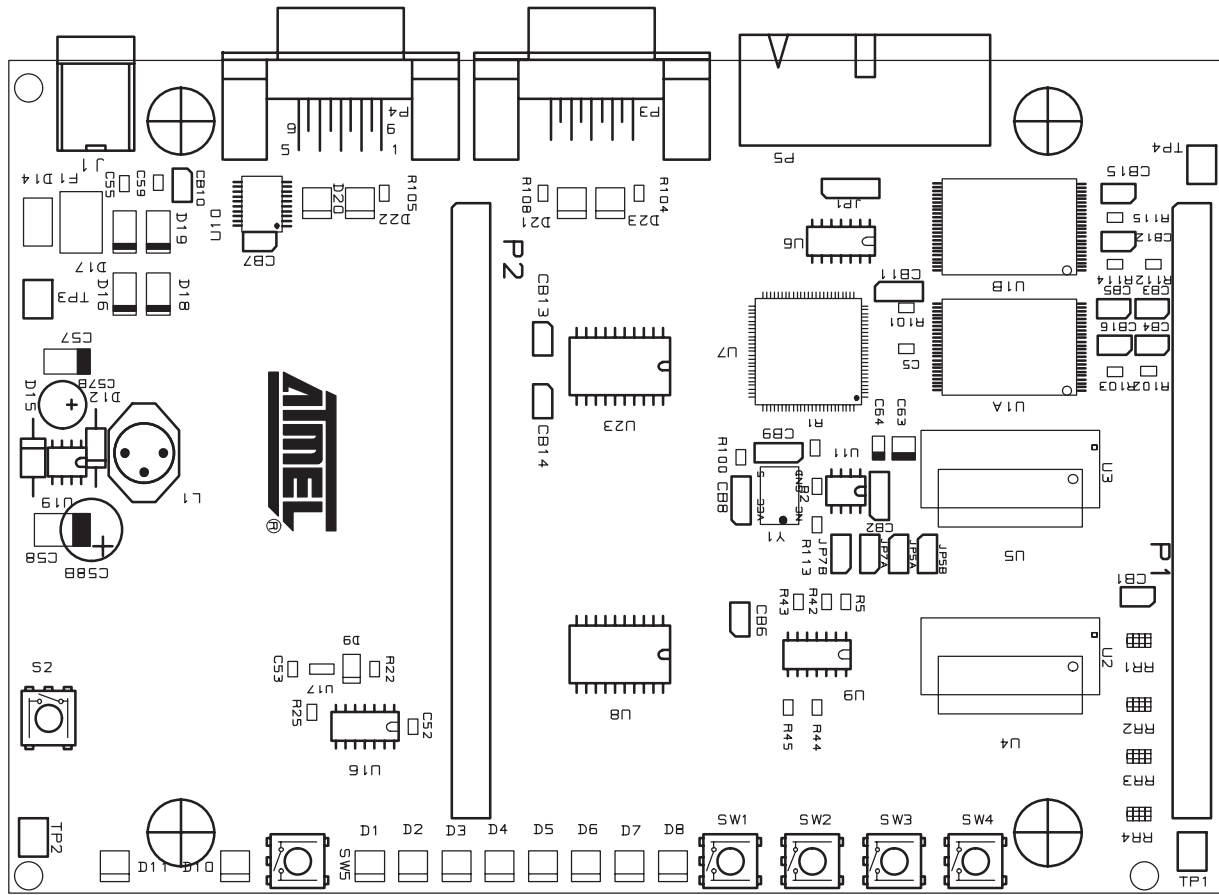

Figure 6-3. Push Buttons, LEDs and Serial Interface

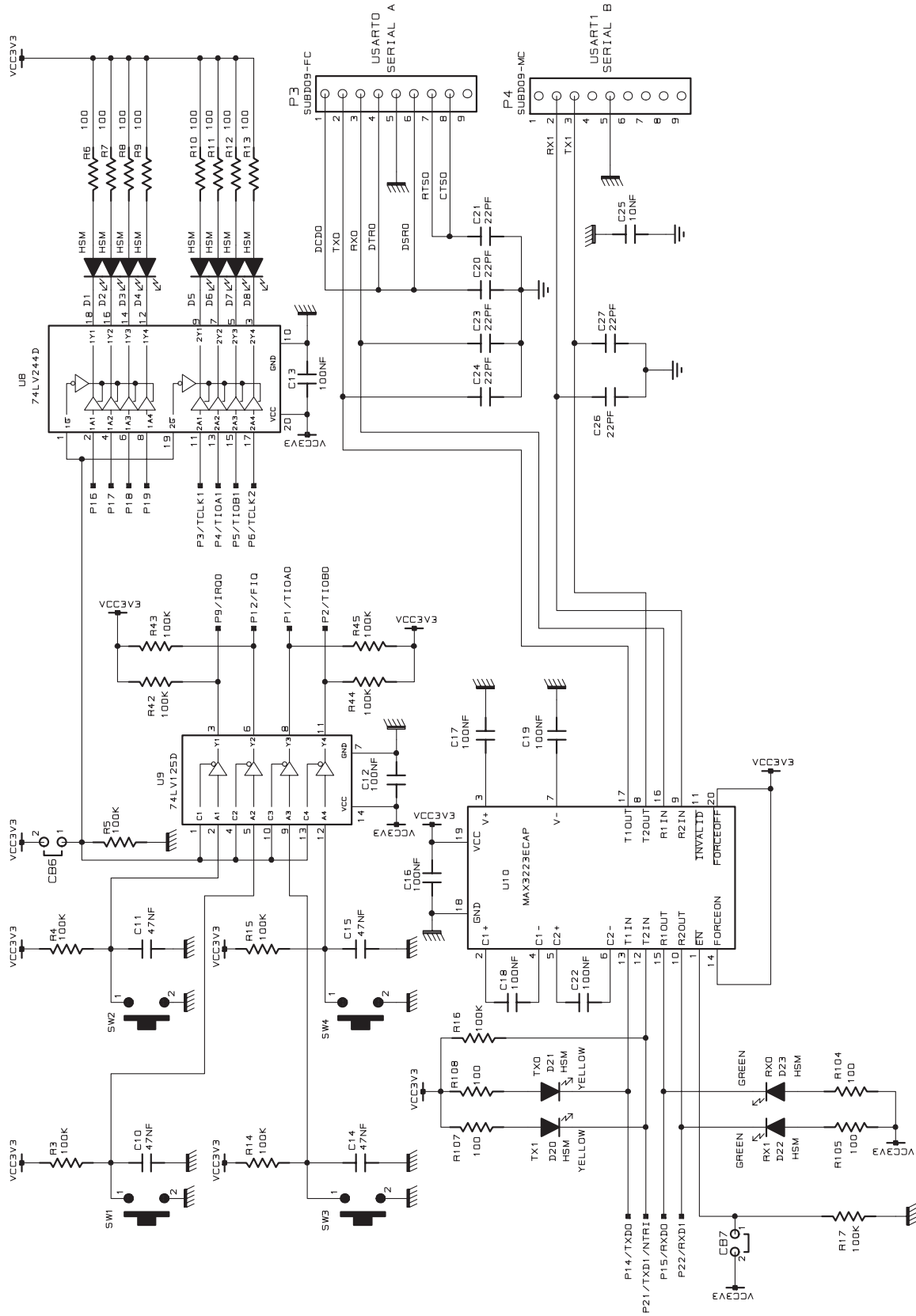
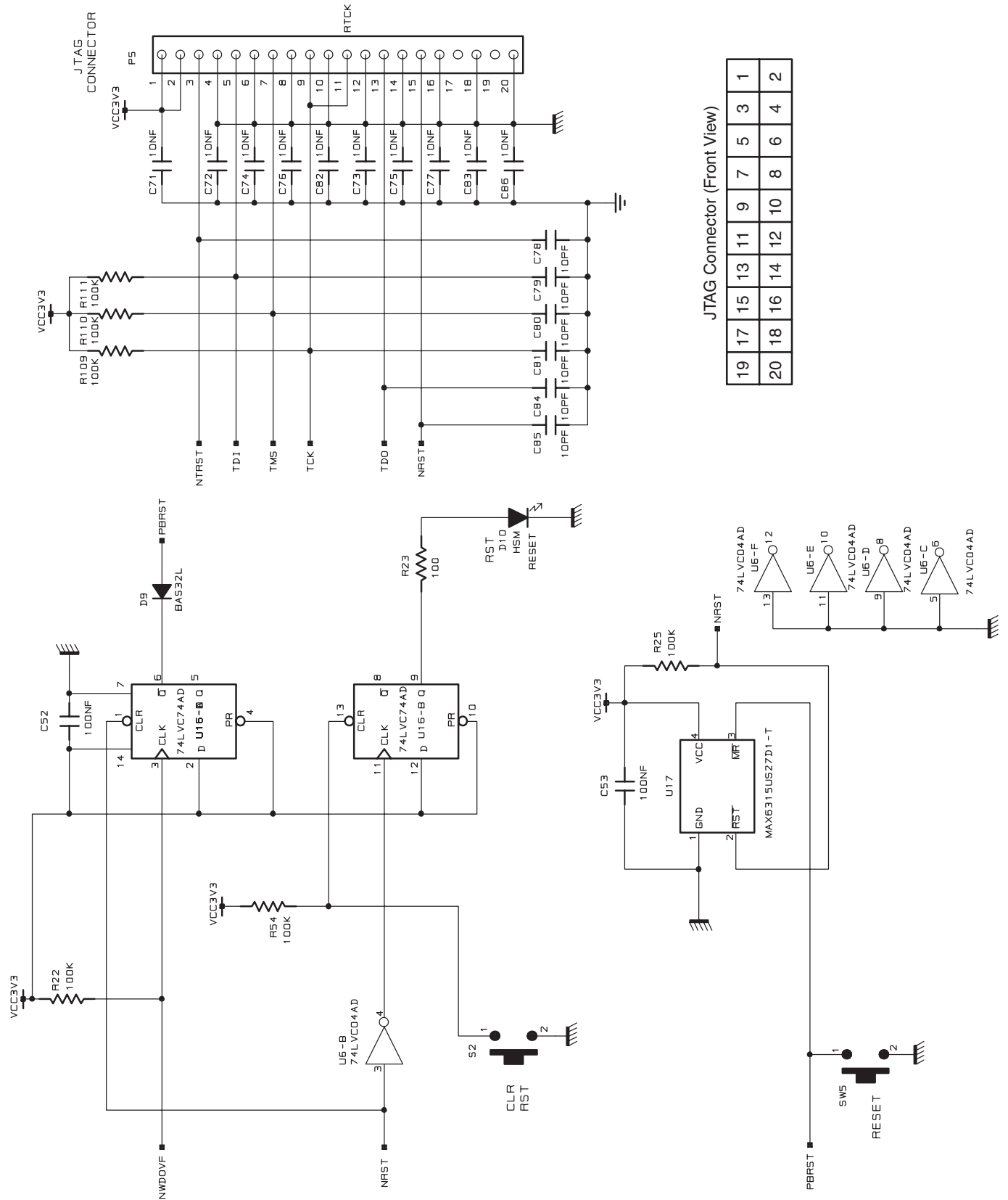

Figure 6-4. Reset and JTAG Interfaces



JTAG Connector (Front View)

19	17	15	13	11	9	7	5	3	1
20	18	16	14	12	10	8	6	4	2

Figure 6-5. AT91R40008

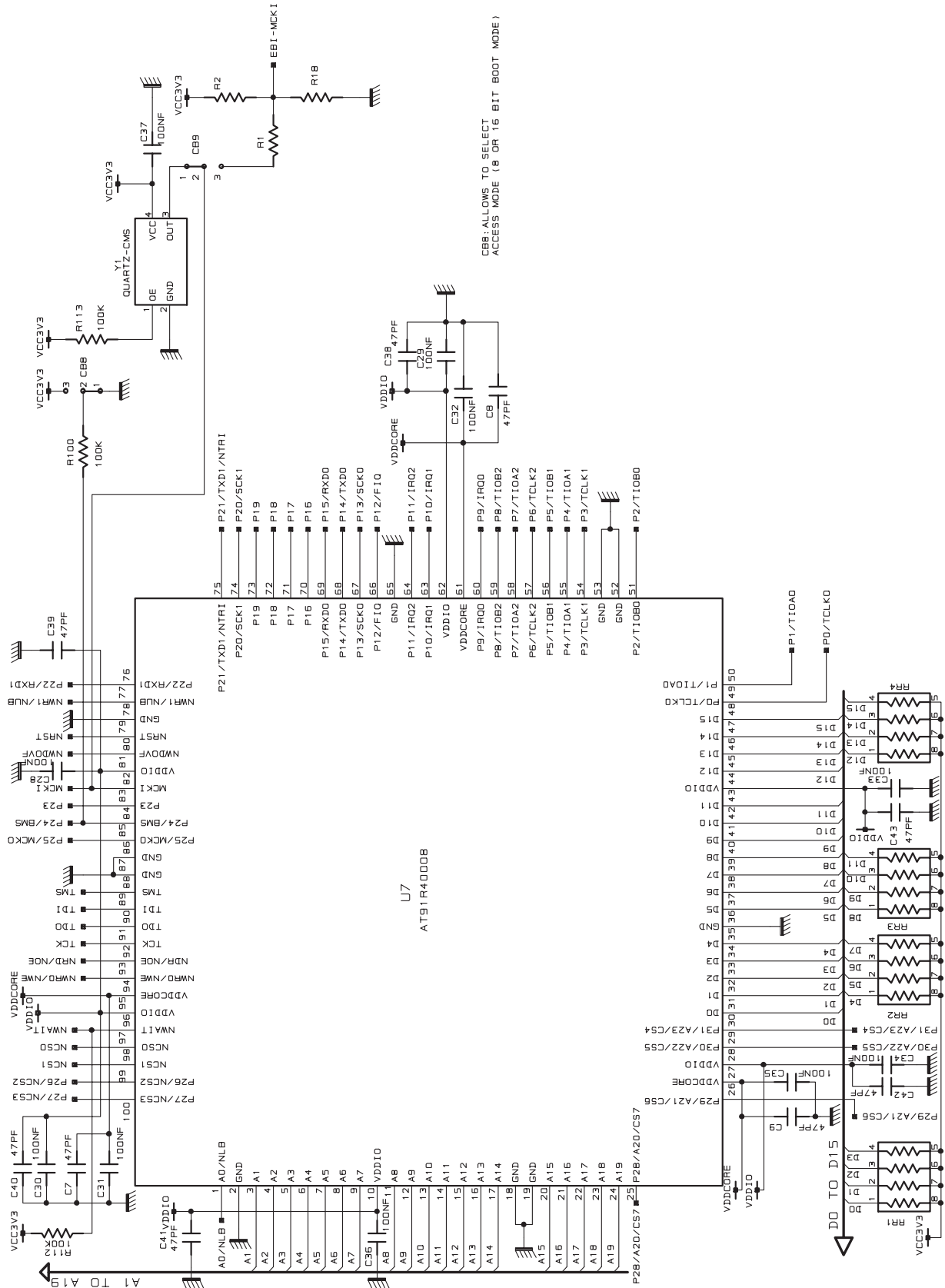

CBB: ALLOWS TO SELECT ACCESS MODE (8 OR 16 BIT BOOT MODE)



Figure 6-6. I/O and EBI Expansion Connectors

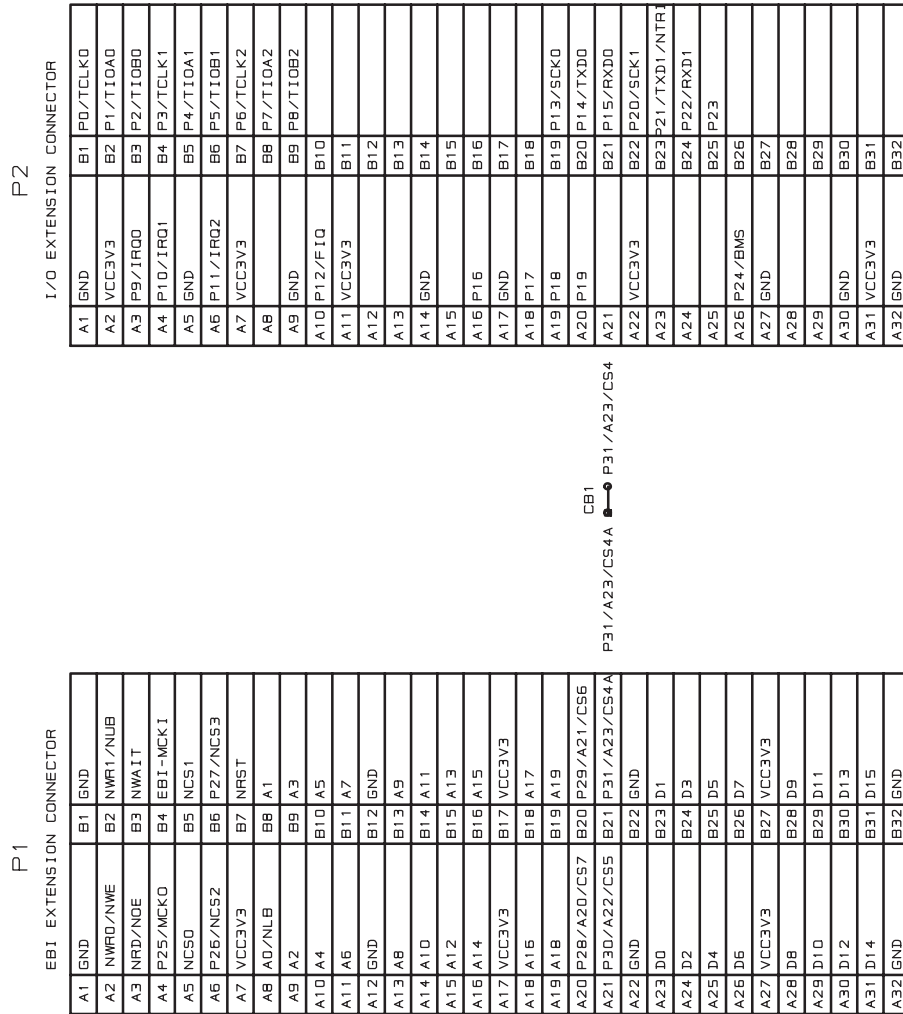
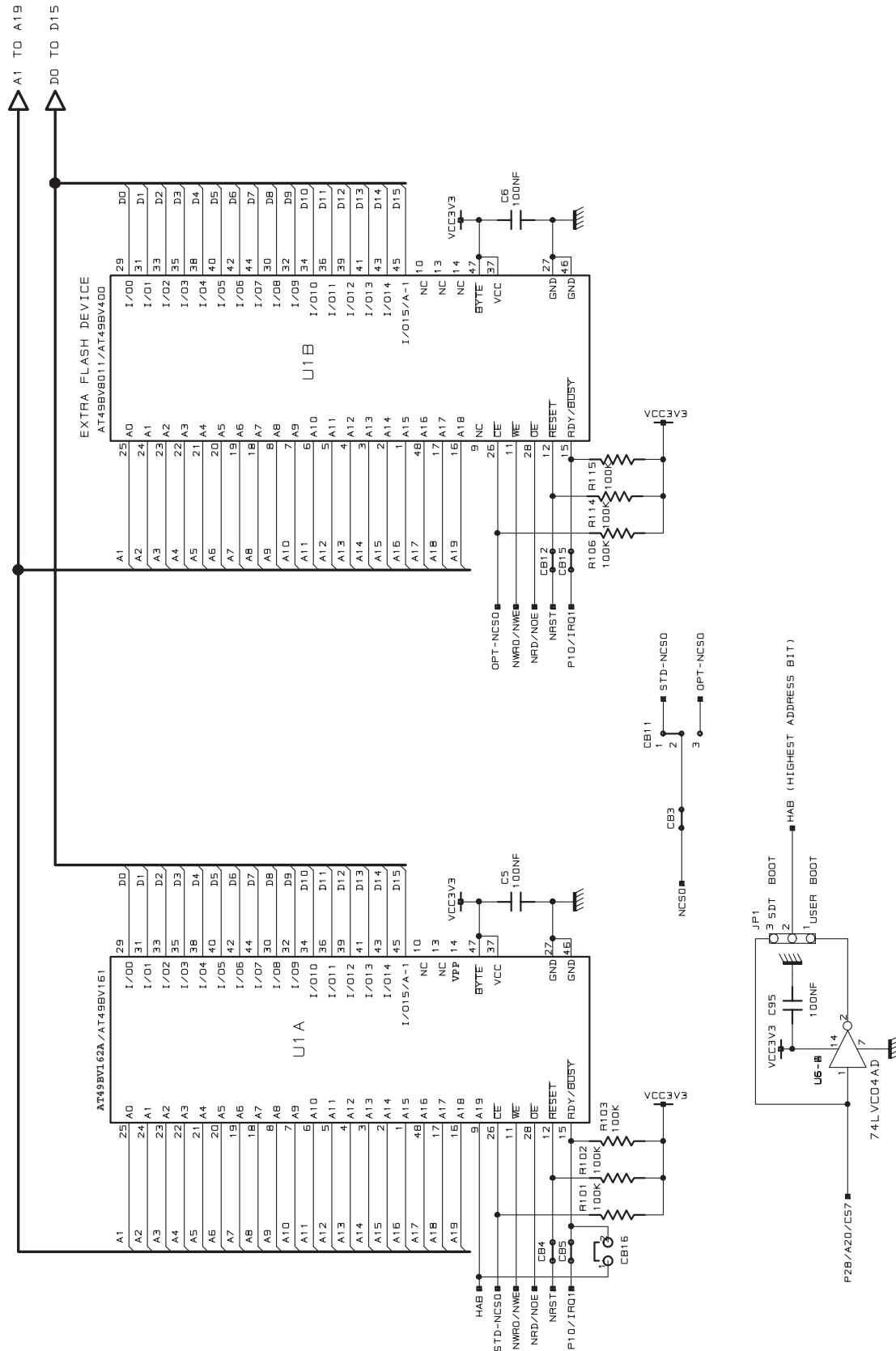

Figure 6-8. Flash Memory Devices







Section 7

Appendix C – Bill of Materials

Table 7-1. Bill of Materials for AT91EB40A

Item	Qty	Reference	Part	Designation	Manufacturer
1	14	R6 to R13, R23, R24, R104, R105, R107, R108	100 Ohm	Resistor 5%	
2	27	R3 to R5, R14 to R17, R22, R25, R31, R42 to R45, R51, R54, R101 to R103, R106, R109 to R115	100k Ohm	Resistor 5%	
3	4	R1, R2, R18, R100		Footprint, resistor	
4	6	C78 to C81, C84, C85	10 pF	Ceramic Capacitor X7R/10V	
5	8	C20, C21, C23, C24, C26, C27, C55, C59	22 pF	Ceramic Capacitor X7R/10V	
6	9	C7, C8, C9, C38 to C43	47 pF	Ceramic Capacitor X7R/10V	
7	1	C60	3.3 nF	Ceramic Capacitor X7R/10V	
8	11	C25, C71 to C77, C82, C83, C86,	10 nF	Ceramic Capacitor X7R/10V	
9	4	C10, C11, C14, C15	47 nF	Ceramic Capacitor X7R/10V	
10	28	C1 to C6, C12, C13, C16 to C19, C22, C28 to C37, C52 to C54, C67, C95	100 nF	Ceramic Capacitor X7R/10V	
11	3	C61, C62, C64	1 μ F	Ceramic Capacitor	
12	1	C63	10 μ F	Capacitor 16V SMT	AVX
13	1	C57	10 μ F	Capacitor 25V SMT	AVX
14	1	C57B	10 μ F	Capacitor 25V-Radial D -CO37	
15	1	C58	100 μ F	Capacitor 100 μ F/10V SMT AVX	AVX
16	1	C58B	100 μ F	Capacitor 100 μ F/10V Radial AVX C-C037	
18	2	JP5A, JP5B, JP7A, JP7B	2 point Jumper	2 point, step 2.54 mm	
20	1	JP1	3 point Jumper	3 point, step 2.54 mm	
21	2	P1, P2		2x32 point Male, step 2.54 mm	
22	2	JP5A, JP5B, JP7A, JP7B		2 point by step 2.54 mm	

Table 7-1. Bill of Materials for AT91EB40A (Continued)

Item	Qty	Reference	Part	Designation	Manufacturer
23	1	J1	Jack Diameter 2.1 mm	Jack Socket \AA 2.1mm	
24	4	TP1, TP2, TP3, TP4	Test Point Corner	SMT Test Point 2.7 x 3.9	
25	1	P3	Sub D 9b F	Sub D 9b Female socket, right angle, mechanical strength, locking	
26	1	P4	Sub D 9b M	Sub D 9b Male socket, right angle, mechanical strength, locking	
27	1	P5	HE10 2x10	HE10 2 x 10 socket, low profile, right angle	AMP
28	1	D9	D-BAS32L	Diode Signal	Philips
29	4	D16 to D19	10MQ100N	Rectifier Diode	I.R.
30	1	D15	1N5817	Schottky Diode 1A/0.45V	Fairchild
31	1	D12	1N914	Diode	Fairchild
32	1	D14	SMT6T15CA	Transil 12.8V / 600W / VBRmini 14.3V	
33	10	D1 to D8, D10, D11,	LED	SMT LED, Red color	
34	2	D22, D23	LED	SMT LED, Green color	
35	2	D20, D21	LED	SMT LED, Yellow color	
36	1	F1	POLYSWITCH	Fuse RARM 1000 mA/30V	
37	1	L1	10 μ H	Self 10 μ H at 1A and 500kHz	
38	6	SW1 to SW5, S2	Push Button	Push Button	KSA
39	1	Y1	66 MHz Oscillator	3.3V SMT Crystal Oscillator HCMOS, K3750 HCE	Koni
40	1	U9	74LV125D	Buffer Tri-state	
41	1	U8	74LV244D	Buffer	
42	1	U6	74LV04AD	Inverters	
43	1	U16	74LV74AD	Dual D Type Flip Flop	
45	2	U1A	AT49BV162A-70TI	16-megabit Flash Memory	Atmel
46	1	U7	AT91R40008	32bit ARM/Thumb Microcontroller	Atmel
47	2	U2, U3	IDT71V424S10Y	SRAM	IDT
48	1	U11	LT1503CS8-1.8	Regulator DC/DC	Linear Tech.
49	1	U19	LT1507CS8-3.3	Regulator DC/DC	Linear Tech.
50	1	U10	MAX3223ECAP	RS232 Driver	Maxim
51	1	U17	MAX6315US27D1-T	Power Supply Supervisor (2.7V Threshold Voltage)	Maxim
52	4	PS1, PS2, PS3, PS4	Board Support	Plastic bases H>10 mm	



Section 8

Appendix D – Flash Memory Mapping

Figure 8-1 shows the embedded software mapping after the remap. It describes the location of the different programs in the AT49BV162A Flash memory and the division into sectors.

Figure 8-1. EB40A Flash Memory Software Mapping

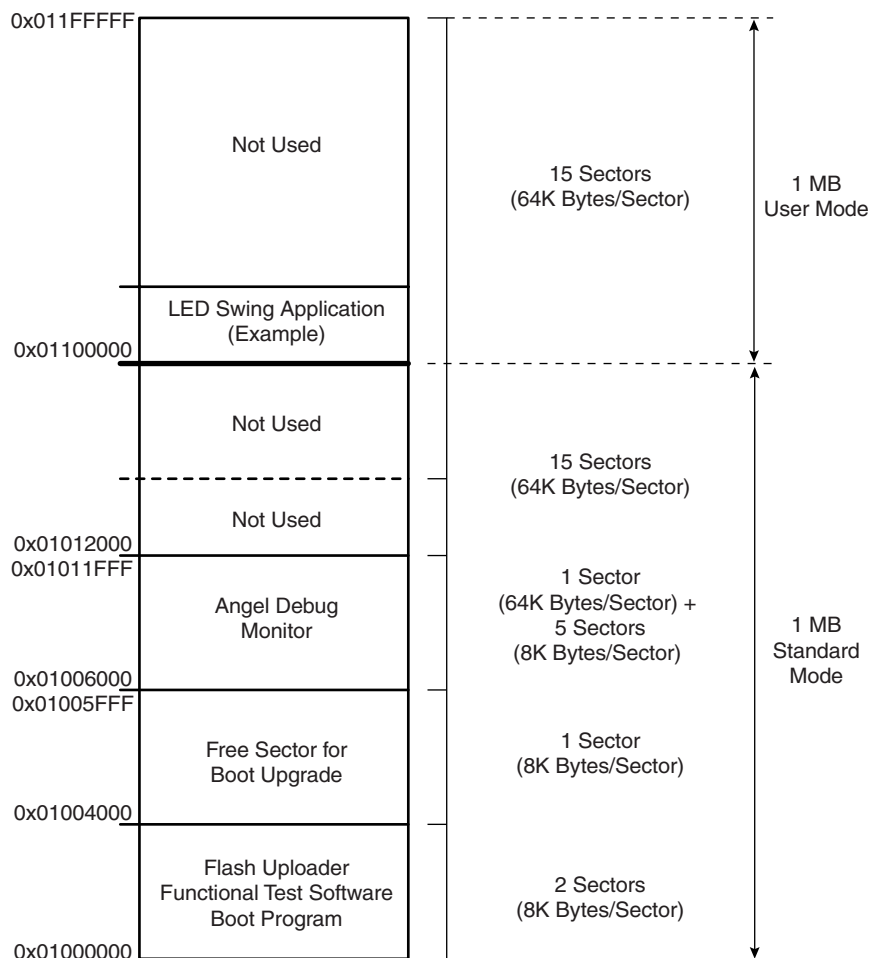



Document Details

Title AT91EB40A Evaluation Board User Guide

Literature Number 2635

Revision History

Version A **Publication Date:** Mar-02

Version B **Publication Date:** 21-Jun-02

Revisions since last issue

Page: 3-2, 3-3 Change in compilation address in SRAM Downloader

Version C **Publication Date:** 13-May-05

Revisions since last issue

Section 1.3 Removed "64K bytes of EEPROM"

Fig.1-1 Removed the Two-wire Interface" box

Section 2.7 Removed "D4 for the EEPROM with two-wire interface access"

Section 3.2 Removed all references to "SRAM Downloader"
Replaced the description of "When SW2 button is pressed" by Reserved

Section 3.4 Removed

Section 3.5 Replaced AT91F40816 and AT91FR4081 by AT91FR4042 and AT91FR4162/S

Section 4.3 Removed "AT24C512 64Kb TWI EEPROM"
Changed "AT49BV1604 or AT49BV1614" to "AT49BV162A"

Section 5.1 Removed the table describing CB13, CB14

Figure 6-2 Removed the U23 part.

Figure 6-8 For U1A part: changed AT49BV1614 to AT40BV162A

Appendix C Removed item 44
Item 45 / "Part" Column --> changed to AT49BV162A-70TI

Appendix D Changed AT49BV1604 and AT49BV1614 to AT49BV162A

Figure 8-1 Updated with new Flash memory ranges



Atmel Corporation

2325 Orchard Parkway
San Jose, CA 95131, USA
Tel: 1(408) 441-0311
Fax: 1(408) 487-2600

Regional Headquarters

Europe

Atmel Sarl
Route des Arsenaux 41
Case Postale 80
CH-1705 Fribourg
Switzerland
Tel: (41) 26-426-5555
Fax: (41) 26-426-5500

Asia

Room 1219
Chinachem Golden Plaza
77 Mody Road Tsimshatsui
East Kowloon
Hong Kong
Tel: (852) 2721-9778
Fax: (852) 2722-1369

Japan

9F, Tonetsu Shinkawa Bldg.
1-24-8 Shinkawa
Chuo-ku, Tokyo 104-0033
Japan
Tel: (81) 3-3523-3551
Fax: (81) 3-3523-7581

Atmel Operations

Memory

2325 Orchard Parkway
San Jose, CA 95131, USA
Tel: 1(408) 441-0311
Fax: 1(408) 436-4314

Microcontrollers

2325 Orchard Parkway
San Jose, CA 95131, USA
Tel: 1(408) 441-0311
Fax: 1(408) 436-4314

La Chantrerie
BP 70602
44306 Nantes Cedex 3, France
Tel: (33) 2-40-18-18-18
Fax: (33) 2-40-18-19-60

ASIC/ASSP/Smart Cards

Zone Industrielle
13106 Rousset Cedex, France
Tel: (33) 4-42-53-60-00
Fax: (33) 4-42-53-60-01

1150 East Cheyenne Mtn. Blvd.
Colorado Springs, CO 80906, USA
Tel: 1(719) 576-3300
Fax: 1(719) 540-1759

Scottish Enterprise Technology Park
Maxwell Building
East Kilbride G75 0QR, Scotland
Tel: (44) 1355-803-000
Fax: (44) 1355-242-743

RF/Automotive

Theresienstrasse 2
Postfach 3535
74025 Heilbronn, Germany
Tel: (49) 71-31-67-0
Fax: (49) 71-31-67-2340

1150 East Cheyenne Mtn. Blvd.
Colorado Springs, CO 80906, USA
Tel: 1(719) 576-3300
Fax: 1(719) 540-1759

Biometrics/Imaging/Hi-Rel MPU/ High Speed Converters/RF Datacom

Avenue de Rochepleine
BP 123
38521 Saint-Egreve Cedex, France
Tel: (33) 4-76-58-30-00
Fax: (33) 4-76-58-34-80

Literature Requests

www.atmel.com/literature

Disclaimer: The information in this document is provided in connection with Atmel products. No license, express or implied, by estoppel or otherwise, to any intellectual property right is granted by this document or in connection with the sale of Atmel products. **EXCEPT AS SET FORTH IN ATMEL'S TERMS AND CONDITIONS OF SALE LOCATED ON ATMEL'S WEB SITE, ATMEL ASSUMES NO LIABILITY WHATSOEVER AND DISCLAIMS ANY EXPRESS, IMPLIED OR STATUTORY WARRANTY RELATING TO ITS PRODUCTS INCLUDING, BUT NOT LIMITED TO, THE IMPLIED WARRANTY OF MERCHANTABILITY, FITNESS FOR A PARTICULAR PURPOSE, OR NON-INFRINGEMENT. IN NO EVENT SHALL ATMEL BE LIABLE FOR ANY DIRECT, INDIRECT, CONSEQUENTIAL, PUNITIVE, SPECIAL OR INCIDENTAL DAMAGES (INCLUDING, WITHOUT LIMITATION, DAMAGES FOR LOSS OF PROFITS, BUSINESS INTERRUPTION, OR LOSS OF INFORMATION) ARISING OUT OF THE USE OR INABILITY TO USE THIS DOCUMENT, EVEN IF ATMEL HAS BEEN ADVISED OF THE POSSIBILITY OF SUCH DAMAGES.** Atmel makes no representations or warranties with respect to the accuracy or completeness of the contents of this document and reserves the right to make changes to specifications and product descriptions at any time without notice. Atmel does not make any commitment to update the information contained herein. Atmel's products are not intended, authorized, or warranted for use as components in applications intended to support or sustain life.

© Atmel Corporation 2005. All rights reserved. Atmel®, logo and combinations thereof, Everywhere You Are® and others are registered trademarks, and others are the trademarks of Atmel Corporation or its subsidiaries. Other terms and product names may be trademarks of others.



Printed on recycled paper.

2635C-ATARM-13-May-05