

# Agilent HSMP-3880 Surface Mount RF PIN Switch Diode

## Data Sheet

### Description/Applications

The HSMP-3880 switching diode is an ultra low distortion device optimized for higher power applications to 1.5 GHz.

A SPICE model is not available for PIN diodes as SPICE does not provide for a key PIN diode characteristic, carrier lifetime.

### Package Lead Code Identification (Top View)

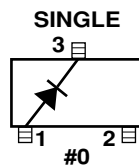

### Features

- Diodes Optimized for: Ultra-Low Distortion Switching
- Surface Mount SOT-23 Package Tape and Reel Options Available
- Low Failure in Time (FIT) Rate<sup>(1)</sup>
- Lead-free Option Available

### Note:

1. For more information see the Surface Mount PIN Reliability Data Sheet.



### Absolute Maximum Ratings<sup>[1]</sup> $T_C = 25^\circ\text{C}$

Symbol	Parameter	Units	Absolute Maximum
$I_F$	Forward Current (1 ms Pulse)	Amp	1
$P_t$	Total Device Dissipation	mW <sup>[2]</sup>	250
$P_{iv}$	Peak Inverse Voltage	—	Same as $V_{BR}$
$T_j$	Junction Temperature	$^\circ\text{C}$	150
$T_{STG}$	Storage Temperature	$^\circ\text{C}$	-65 to 150

#### Notes:

1. Operation in excess of any one of these conditions may result in permanent damage to this device.
2. CW Power Dissipation at  $T_{LEAD} = 25^\circ\text{C}$ . Derate to zero at maximum rated temperature.

### Typical Parameters at $T_C = 25^\circ\text{C}$

Part Number HSMP-	Series Resistance $R_S$ ( $\Omega$ )	Carrier Lifetime $\tau$ (ns)	Reverse Recovery Time $T_{rr}$ (ns)	Total Capacitance $C_T$ (pF)
3880	3.8	2500	550	0.30 @ 50 V
Test Conditions	$I_F = 10$ mA $f = 100$ MHz	$I_F = 50$ mA $I_R = 250$ mA	$V_R = 10$ V $I_F = 20$ mA 90% Recovery	

### Electrical Specifications $T_C = 25^\circ\text{C}$

Part Number HSMP-	Package Marking Code <sup>[1]</sup>	Lead Code	Configuration	Minimum Breakdown Voltage $V_{BR}$ (V)	Maximum Series Resistance $R_S$ ( $\Omega$ )	Maximum Total Capacitance $C_T$ (pF)	Maximum Shunt Mode Harmonic Distortion Hmd (dBc)
3880	S0	0	Single	100	6.5	0.40	-55
Test Conditions				$V_R = V_{BR}$ Measure $I_R \leq 10$ $\mu\text{A}$	$I_F = 5$ mA $f = 100$ MHz	$V_R = 50$ V $f = 1$ MHz	$2f_o, Z_o = 50$ W $f_o = 400$ MHz $P_{in} = +30$ dBm 0 V bias

#### Note:

1. Package marking code is white.

**Typical Parameters at  $T_C = 25^\circ\text{C}$  (unless otherwise noted), Single Diode**

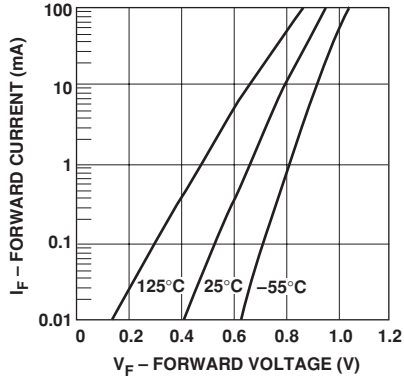

Figure 1. Forward Current vs. Forward Voltage.

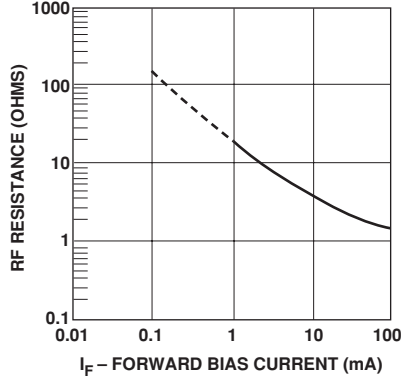

Figure 2. RF Resistance at  $25^\circ\text{C}$  vs. Forward Bias Current.

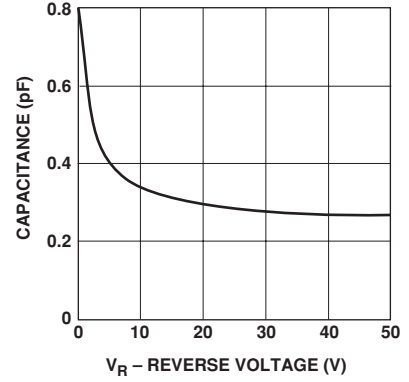

Figure 3. Capacitance vs. Reverse Voltage.

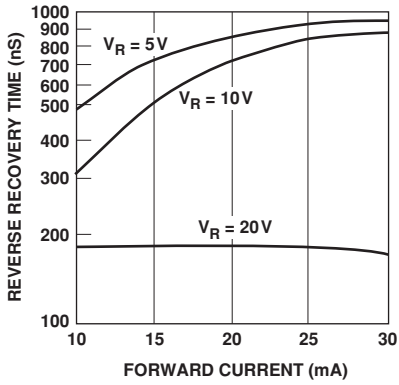

Figure 4. Typical Reverse Recovery Time vs. Reverse Voltage.

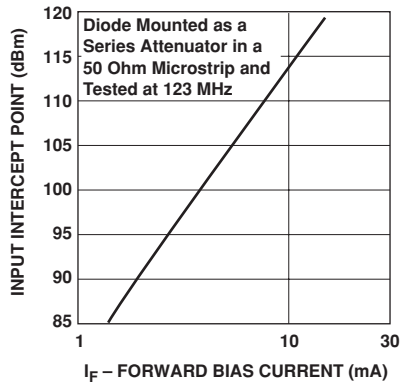
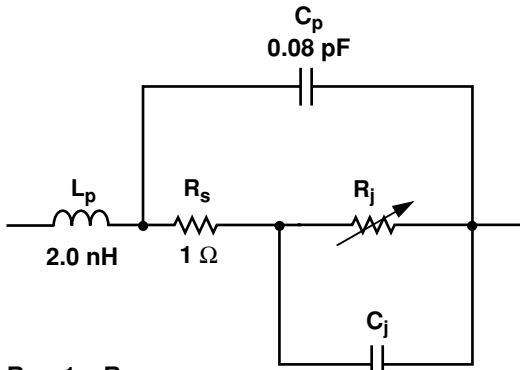

Figure 5. 2nd Harmonic Input Intercept Point vs. Forward Bias Current.

**Equivalent Circuit Model  
HSMP-3880**



$$R_T = 1 + R_j$$

$$C_T = C_p + C_j$$

$$R_j = \frac{49}{I^{0.9}} \Omega$$

\* Measured at -50 V

I = Forward Bias Current in mA

## Package Dimensions Outline 23 (SOT-23)

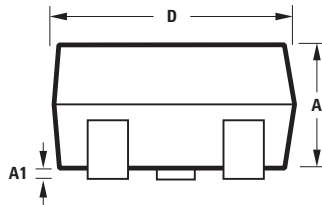
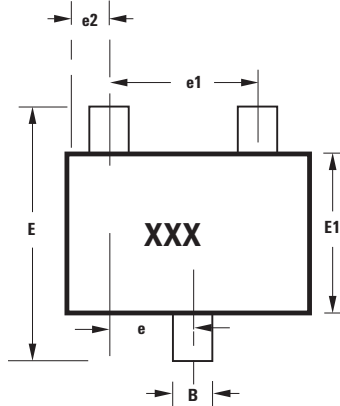

Notes:  
XXX-package marking  
Drawings are not to scale

SYMBOL	DIMENSIONS (mm)	
	MIN.	MAX.
A	0.79	1.20
A1	0.000	0.100
B	0.37	0.54
C	0.086	0.152
D	2.73	3.13
E1	1.15	1.50
e	0.89	1.02
e1	1.78	2.04
e2	0.45	0.60
E	2.10	2.70
L	0.45	0.69

## Recommended PCB Pad Layout for Agilent's SOT-23 Products

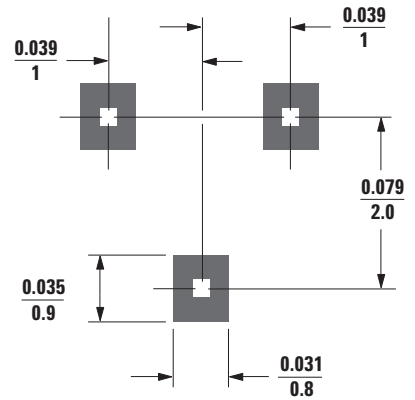

Dimensions in  $\frac{\text{inches}}{\text{mm}}$

## Package Characteristics

Lead Material ..... Alloy 42

Lead Finish ..... Tin-Lead 85-15% (Non lead-free option)  
or Tin 100% (Lead-free option)

Maximum Soldering Temperature ..... 260°C for 5 seconds

Minimum Lead Strength ..... 2 pounds pull

Typical Package Inductance ..... 2 nH

Typical Package Capacitance ..... 0.08 pF (opposite leads)

## Profile Option Descriptions

- BLK = Bulk
- TR1 = 3K pc. Tape and Reel, Device Orientation; See Figure 6
- TR2 = 10K pc. Tape and Reel, Device Orientation; See Figure 6

Tape and Reeling conforms to Electronic Industries RS-481, "Taping of Surface Mounted Components for Automated Placement."

For lead-free option, the part number will have the character "G" at the end, e.g., TR2G for a 10K pc lead-free reel.

## Ordering Information

Specify part number followed by option under. For example:

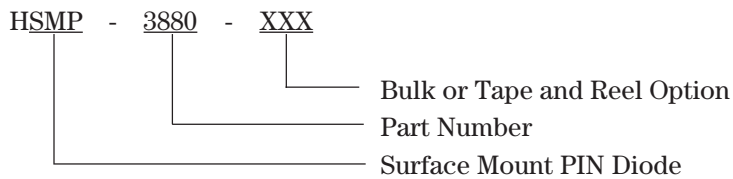

## Device Orientation

### For Outline SOT-23

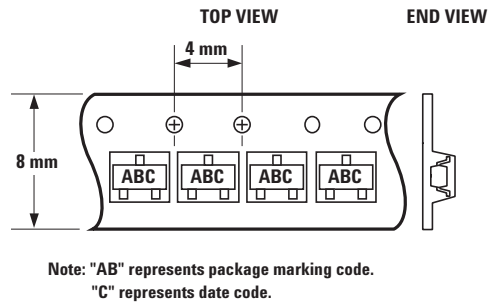
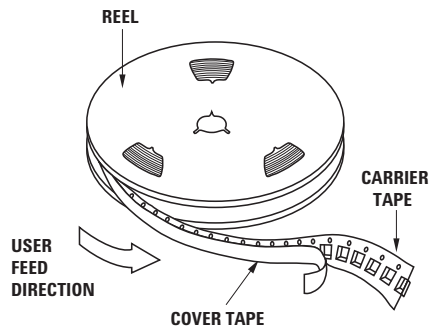
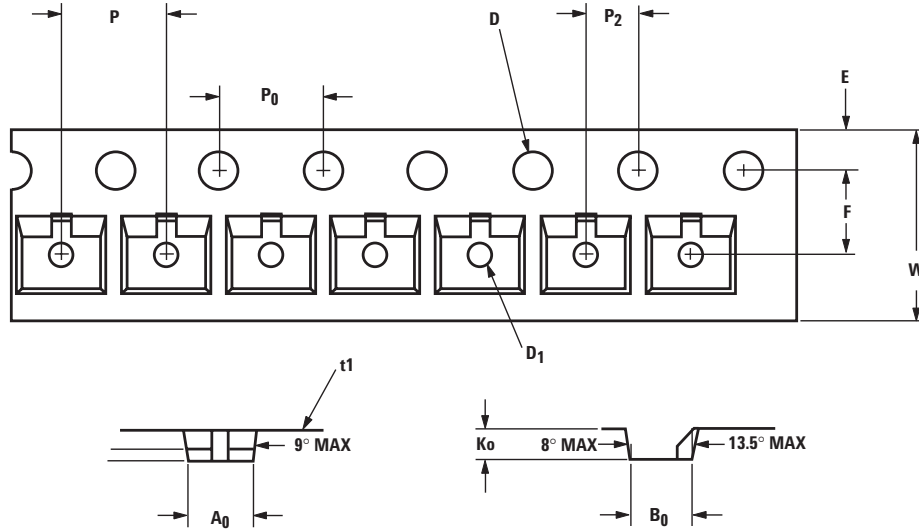

Figure 6. Options -TR1, -TR2 for SOT-23 Package.

## Tape Dimensions and Product Orientation For Outline SOT-23



DESCRIPTION		SYMBOL	SIZE (mm)	SIZE (INCHES)
CAVITY	LENGTH	A <sub>0</sub>	3.15 ± 0.10	0.124 ± 0.004
	WIDTH	B <sub>0</sub>	2.77 ± 0.10	0.109 ± 0.004
	DEPTH	K <sub>0</sub>	1.22 ± 0.10	0.048 ± 0.004
	PITCH	P	4.00 ± 0.10	0.157 ± 0.004
	BOTTOM HOLE DIAMETER	D <sub>1</sub>	1.00 + 0.05	0.039 ± 0.002
PERFORATION	DIAMETER	D	1.50 + 0.10	0.059 + 0.004
	PITCH	P <sub>0</sub>	4.00 ± 0.10	0.157 ± 0.004
	POSITION	E	1.75 ± 0.10	0.069 ± 0.004
CARRIER TAPE	WIDTH	W	8.00 + 0.30 - 0.10	0.315 + 0.012 - 0.004
	THICKNESS	t <sub>1</sub>	0.229 ± 0.013	0.009 ± 0.0005
DISTANCE BETWEEN CENTERLINE	CAVITY TO PERFORATION (WIDTH DIRECTION)	F	3.50 ± 0.05	0.138 ± 0.002
	CAVITY TO PERFORATION (LENGTH DIRECTION)	P <sub>2</sub>	2.00 ± 0.05	0.079 ± 0.002

### [www.agilent.com/semiconductors](http://www.agilent.com/semiconductors)

For product information and a complete list of distributors, please go to our web site.

For technical assistance call:

Americas/Canada: +1 (800) 235-0312 or (916) 788-6763

Europe: +49 (0) 6441 92460

China: 10800 650 0017

Hong Kong: (+65) 6756 2394

India, Australia, New Zealand: (+65) 6755 1939

Japan: (+81 3) 3335-8152(Domestic/International), or 0120-61-1280(Domestic Only)

Korea: (65) 6755 1989

Singapore, Malaysia, Vietnam, Thailand, Philippines, Indonesia: (65) 6755 2044

Taiwan: (65) 6755 1843

Data subject to change.

Copyright © 2005 Agilent Technologies, Inc.

Obsoletes 5988-9924EN

July 20, 2005

5989-2502EN



**Agilent Technologies**