

# T-1<sup>3/4</sup> (5 mm) High Intensity LED Lamps

## Technical Data

**HLMP-331x Series**  
**HLMP-341x Series**  
**HLMP-351x Series**

### Features

- **High Intensity**
- **Choice of 3 Bright Colors**  
 High Efficiency Red  
 Yellow  
 High Performance Green
- **Popular T-1<sup>3/4</sup> Diameter Package**
- **Selected Minimum Intensities**
- **Narrow Viewing Angle**
- **General Purpose Leads**

- **Reliable and Rugged**
- **Available on Tape and Reel**

### Description

This family of T-1<sup>3/4</sup> nondiffused LED lamps is specially designed for applications requiring higher on-axis intensity than is achievable with a standard lamp. The light generated is focused to a narrow beam to achieve this effect.

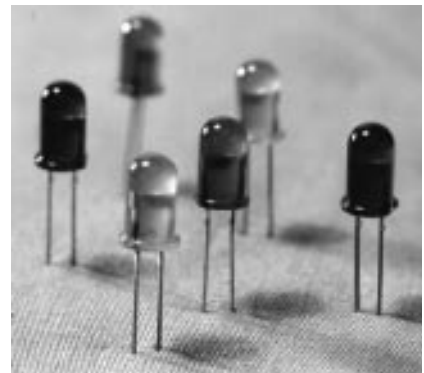

### Selection Guide

Color	Part Number	Luminous Intensity I <sub>v</sub> (mcd) @ 10 mA	
		Min.	Max.
Red	HLMP-3315	13.8	-
	HLMP-3317	22.00	-
	HLMP-3316-I00xx	22.0	-
	HLMP-3316-IJ0xx	22.0	70.4
Yellow	HLMP-3415	9.2	-
	HLMP-3416	14.7	-
	HLMP-3416-G00xx	14.7	-
	HLMP-3416-IJ0xx	37.6	120.2
Green	HLMP-3517	6.7	-
	HLMP-3519	10.6	-
	HLMP-3519-F00xx	10.6	-
	HLMP-3519-IJ0xx	43.6	139.6

## Package Dimensions

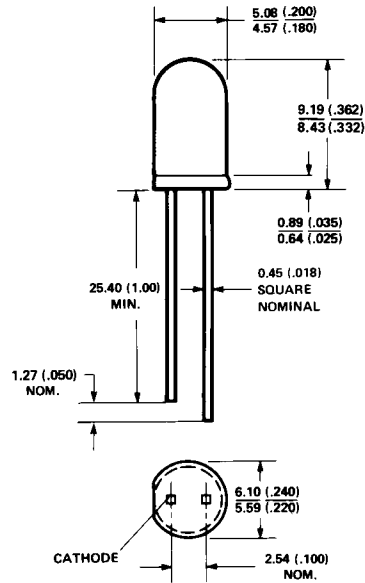

NOTES:  
 1. ALL DIMENSIONS ARE IN MILLIMETRES (INCHES).  
 2. AN EPOXY MENISCUS MAY EXTEND ABOUT 1mm (.040") DOWN THE LEADS.

## Part Numbering System

HLMP - 3 x 1 x - x x x xx

### Mechanical Option

00: Bulk  
 01: Tape & Reel, Crimped Leads  
 02: Tape & Reel, Straight Leads  
 B1: Right Angle Housing, Uneven Leads  
 B2: Right Angle Housing, Even Leads

### Color Bin Options

0: Full Color Bin Distribution

### Maximum Iv Bin Options

0: Open (no max. limit)  
 Others: Please refer to the Iv Bin Table

### Minimum Iv Bin Options

Please refer to the Iv Bin Table

### Brightness Level

5, 7: Less Brightness  
 6, 9: Higher Brightness

### Color Options

3: GaP HER  
 4: GaP Yellow  
 5: GaP Green

### Electrical Characteristics at $T_A = 25^\circ\text{C}$

Symbol	Description	Device HLMP-	Min.	Typ.	Max.	Units	Test Conditions
$I_V$	Luminous Intensity	3315 3316	13.8 22	40.0 60.0		mcd	$I_F = 10\text{ mA}$ (Figure 3)
		3415 3416	9.2 14.7	40.0 50.0		mcd	$I_F = 10\text{ mA}$ (Figure 8)
		3517 3519	6.7 10.6	50.0 70.0		mcd	$I_F = 10\text{ mA}$ (Figure 13)
$2\theta^{1/2}$	Including Angle Between Half Luminous Intensity Points	3315 3316		35 35		Deg.	$I_F = 10\text{ mA}$ See Note 1 (Figure 6)
		3415 3416		35 35		Deg.	$I_F = 10\text{ mA}$ See Note 1 (Figure 11)
		3517 3519		24 24		Deg.	$I_F = 10\text{ mA}$ See Note 1 (Figure 16)
$\lambda_{\text{PEAK}}$	Peak Wavelength	331X 341X 351X		635 583 565		nm	Measurement at Peak (Figure 1)
$\Delta\lambda_{1/2}$	Spectral Line Halfwidth	331X 341X 351X		40 36 28		nm	
$\lambda_d$	Dominant Wavelength	331X 341X 351X		626 585 569		nm	See Note 2 (Figure 1)
$\tau_s$	Speed of Response	331X 341X 351X		90 90 500		ns	
C	Capacitance	331X 341X 351X		11 15 18		pF	$V_F = 0$ ; $f = 1\text{ MHz}$
$R\theta_{\text{J-PIN}}$	Thermal Resistance	331X 341X 351X		260		$^\circ\text{C/W}$	Junction to Cathode Lead
$V_F$	Forward Voltage	331X 341X 351X		1.9 2.0 2.1	2.4 2.4 2.7	V	$I_F = 10\text{ mA}$ (Figure 2) $I_F = 10\text{ mA}$ (Figure 7) $I_F = 10\text{ mA}$ (Figure 12)
$V_R$	Reverse Breakdown Volt.	All	5.0			V	$I_R = 100\ \mu\text{A}$
$\eta_V$	Luminous Efficacy	331X 341X 351X		145 500 595		lumens Watt	See Note 3

#### Notes:

- $\theta_{1/2}$  is the off-axis angle at which the luminous intensity is half the axial luminous intensity.
- The dominant wavelength,  $\lambda_d$ , is derived from the CIE chromaticity diagram and represents the single wavelength which defines the color of the device.
- Radiant intensity,  $I_e$ , in watts/steradian, may be found from the equation  $I_e = I_V/\eta_V$ , where  $I_V$  is the luminous intensity in candelas and  $\eta_V$  is the luminous efficacy in lumens/watt.

### Absolute Maximum Ratings at $T_A = 25^\circ\text{C}$

Parameter	331X Series	341X Series	351X Series	Units
Peak Forward Current	90	60	90	mA
Average Forward Current <sup>[1]</sup>	25	20	25	mA
DC Current <sup>[2]</sup>	30	20	30	mA
Power Dissipation <sup>[3]</sup>	135	85	135	mW
Reverse Voltage ( $I_R = 100 \mu\text{A}$ )	5	5	5	V
Transient Forward Current <sup>[4]</sup> (10 $\mu\text{sec}$ Pulse)	500	500	500	mA
LED Junction Temperature	110	110	110	$^\circ\text{C}$
Operating Temperature Range	-55 to +100	-55 to +100	-20 to +100	$^\circ\text{C}$
Storage Temperature Range			-55 to +100	
Lead Soldering Temperature [1.6 mm (0.063 in.) from body]	260 $^\circ\text{C}$ for 5 seconds			

#### Notes:

1. See Figure 5 (Red), 10 (Yellow), or 15 (Green) to establish pulsed operating conditions.
2. For Red and Green series derate linearly from 50 $^\circ\text{C}$  at 0.5 mA/ $^\circ\text{C}$ . For Yellow series derate linearly from 50 $^\circ\text{C}$  at 0.2 mA/ $^\circ\text{C}$ .
3. For Red and Green series derate power linearly from 25 $^\circ\text{C}$  at 1.8 mW/ $^\circ\text{C}$ . For Yellow series derate power linearly from 50 $^\circ\text{C}$  at 1.6 mW/ $^\circ\text{C}$ .
4. The transient peak current is the maximum non-recurring peak current that can be applied to the device without damaging the LED die and wirebond. It is not recommended that the device be operated at peak currents beyond the peak forward current listed in the Absolute Maximum Ratings.

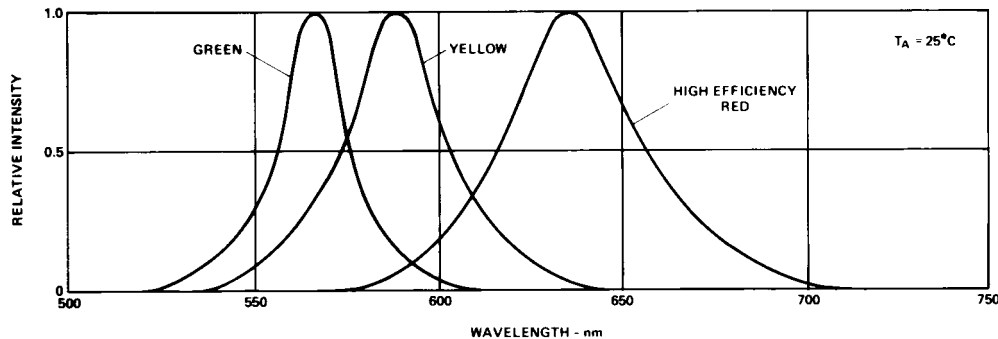

Figure 1. Relative Intensity vs. Wavelength.

## High Efficiency Red HLMP-331X Series

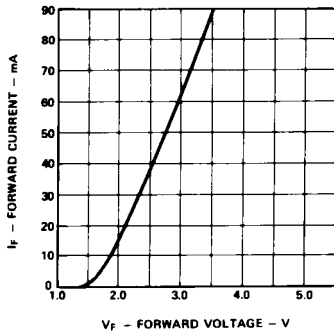

Figure 2. Forward Current vs. Forward Voltage Characteristics.

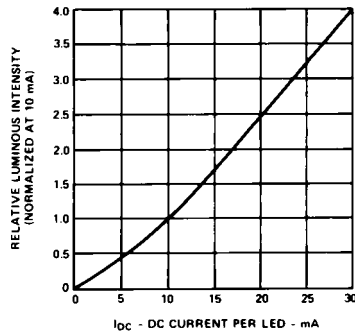

Figure 3. Relative Luminous Intensity vs. DC Forward Current.

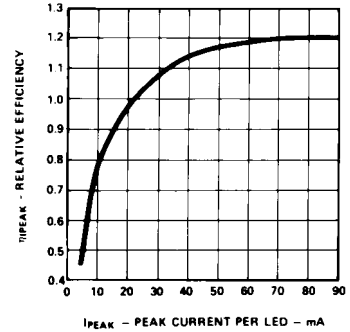

Figure 4. Relative Efficiency (Luminous Intensity per Unit Current) vs. Peak LED Current.

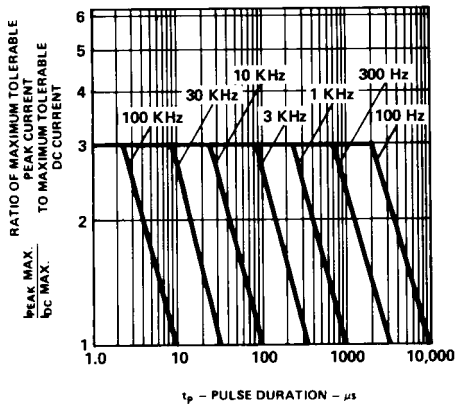

Figure 5. Maximum Tolerable Peak Current vs. Pulse Duration ( $I_{DC}$  MAX as per MAX Ratings).

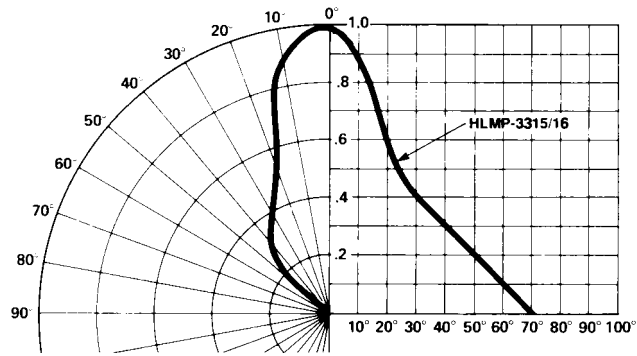

Figure 6. Relative Luminous Intensity vs. Angular Displacement.

## Yellow HLMP-341X Series

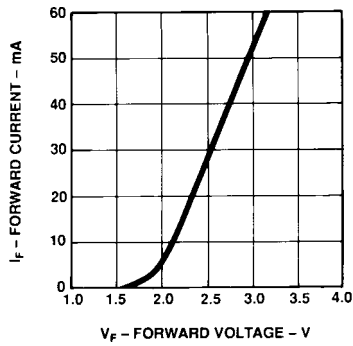

Figure 7. Forward Current vs. Forward Voltage Characteristics.

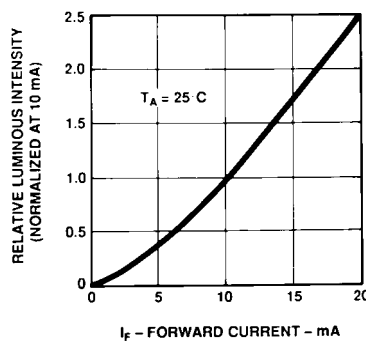

Figure 8. Relative Luminous Intensity vs. DC Forward Current.

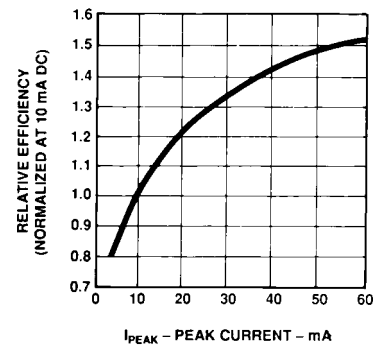

Figure 9. Relative Efficiency (Luminous Intensity per Unit Current) vs. Peak Current.

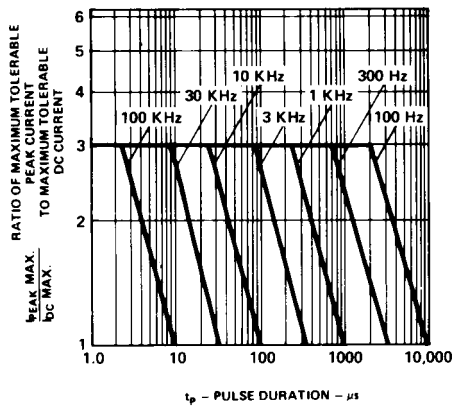

Figure 10. Maximum Tolerable Peak Current vs. Pulse Duration ( $I_{DC}$  MAX as per MAX Ratings).

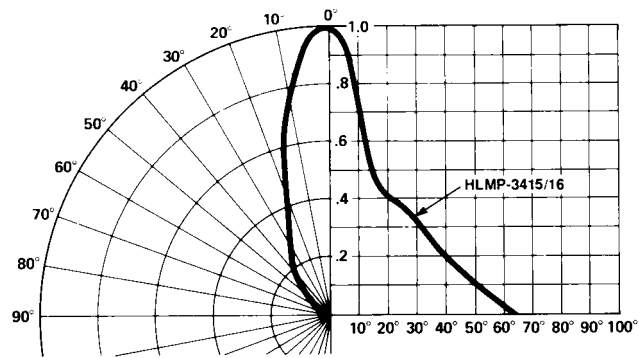

Figure 11. Relative Luminous Intensity vs. Angular Displacement.

## Green HLMP-351X Series

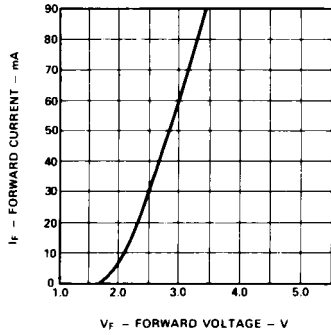

Figure 12. Forward Current vs. Forward Voltage Characteristics.

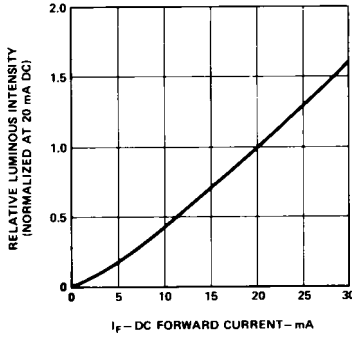

Figure 13. Relative Luminous Intensity vs. DC Forward Current.

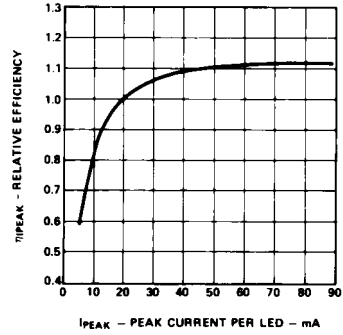

Figure 14. Relative Efficiency (Luminous Intensity per Unit Current) vs. Peak LED Current.

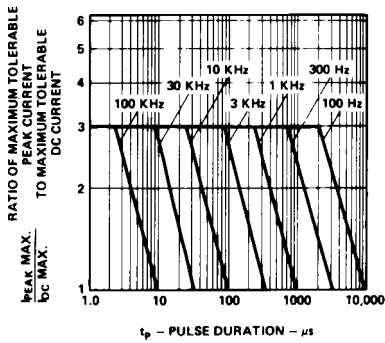

Figure 15. Maximum Tolerable Peak Current vs. Pulse Duration ( $I_{DC\ MAX}$  as per MAX Ratings).

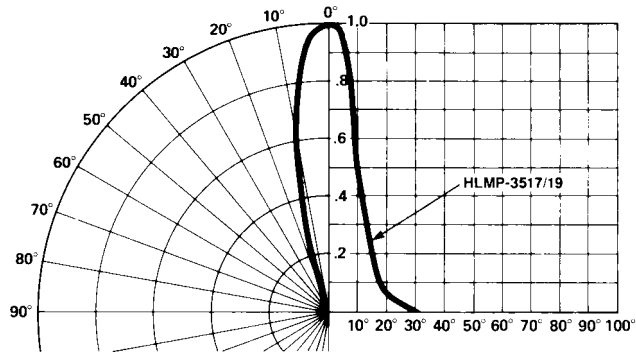

Figure 16. Relative Luminous Intensity vs. Angular Displacement. T-1<sup>3/4</sup> Lamp.

**Table 2. Intensity Bin Limit**

Color	Bin	Intensity Range (mcd)	
		Min.	Max.
Red	H	15.5	24.8
	I	24.8	39.6
	J	39.6	63.4
	K	63.4	101.5
	L	101.5	162.4
	M	162.4	234.6
	N	234.6	340.0
	O	340.0	540.0
	P	540.0	850.0
	Q	850.0	1200.0
	R	1200.0	1700.0
	S	1700.0	2400.0
	T	2400.0	3400.0
	U	3400.0	4900.0
	V	4900.0	7100.0
	W	7100.0	10200.0
	X	10200.0	14800.0
Y	14800.0	21400.0	
Z	21400.0	30900.0	

**Table 2. (Cont'd)**

Color	Bin	Intensity Range (mcd)	
		Min.	Max.
Yellow	G	16.6	26.5
	H	26.5	42.3
	I	42.3	67.7
	J	67.7	108.2
	K	108.2	173.2
	L	173.2	250.0
	M	250.0	360.0
	N	360.0	510.0
	O	510.0	800.0
	P	800.0	1250.0
	Q	1250.0	1800.0
	R	1800.0	2900.0
	S	2900.0	4700.0
	T	4700.0	7200.0
	U	7200.0	11700.0
	V	11700.0	18000.0
	W	18000.0	27000.0

**Table 2. (Cont'd)**

Color	Bin	Intensity Range (mcd)	
		Min.	Max.
Green	E	7.6	12.0
	F	12.0	19.1
	G	19.1	30.7
	H	30.7	49.1
	I	49.1	78.5
	J	78.5	125.7
	K	125.7	201.1
	L	201.1	289.0
	M	289.0	417.0
	N	417.0	680.0
	O	680.0	1100.0
	P	1100.0	1800.0
	Q	1800.0	2700.0
	R	2700.0	4300.0
	S	4300.0	6800.0
	T	6800.0	10800.0
	U	10800.0	16000.0
V	16000.0	25000.0	
W	25000.0	40000.0	

Maximum tolerance for each bin limit is  $\pm 18\%$ .



### Color Categories

Color	Cat #	Lambda (nm)	
		Min.	Max.
Green	6	561.5	564.5
	5	564.5	567.5
	4	567.5	570.5
	3	570.5	573.5
	2	573.5	576.5
Yellow	1	582.0	584.5
	3	584.5	587.0
	2	587.0	589.5
	4	589.5	592.0
	5	592.0	593.0

Tolerance for each bin limit is  $\pm 0.5$  nm.

### Mechanical Option Matrix

Mechanical Option Code	Definition
00	Bulk Packaging, minimum increment 500 pcs/bag
01	Tape & Reel, crimped leads, minimum increment 1300 pcs/bag
02	Tape & Reel, straight leads, minimum increment 1300 pcs/bag
B1	Right Angle Housing, uneven leads, minimum increment 500 pcs/bag
B2	Right Angle Housing, even leads, minimum increment 500 pcs/bag

**Note:**

All Categories are established for classification of products. Products may not be available in all categories. Please contact your local Agilent representative for further clarification/information.

