

# Wire Wound Magnetically Shielded SMD Power Inductor



4.0 x 4.0 x 2.0 mm

ASPI-4020S



RoHS/RoHS II Compliant

## FEATURES:

- Shielded magnetics, low radiation
- Large Terminal surface for good PCB bonding
- Low DCR, High Energy storage, suitable for large currents
- Ideal for a variety of DC-DC converter inductor applications

## APPLICATIONS:

- Portable communication equipment
- OA equipment
- LCD, DVD, modem, set-top box
- DC/DC converters

## ELECTRICAL SPECIFICATIONS:

Abracon P/N:	ASPI-4020S Series
Operating Temperature :	-40°C to +125°C
Storage Temperature :	-10°C to +40°C and 70% R.H.

Part Number	Inductance	L Tolerance	DC Resistance (±30%)	Saturation Current	Temperature Rise Current	Self resonant frequency	Inductance Code Marking
Units	µH	—	Ω	A Max	A Max	MHz Min	
Symbol	L	N, M	DCR	Isat	Irms	SRF	
ASPI-4020S-1R0	1.0	N	0.029	4.78	2.15	75	1R0
ASPI-4020S-1R2	1.2	N	0.029	5.10	2.15	72	1R2
ASPI-4020S-1R5	1.5	N	0.035	4.45	1.98	71	1R5
ASPI-4020S-2R2	2.2	N	0.040	3.40	1.85	49	2R2
ASPI-4020S-3R3	3.3	M	0.070	3.20	1.40	44	3R3
ASPI-4020S-3R6	3.6	M	0.055	2.80	1.54	49	3R6
ASPI-4020S-4R7	4.7	M	0.075	2.35	1.34	42	4R7
ASPI-4020S-5R1	5.1	M	0.085	2.30	1.27	42	5R1
ASPI-4020S-5R6	5.6	M	0.090	2.20	1.22	30	5R6
ASPI-4020S-6R2	6.2	M	0.115	2.15	1.08	36	6R2
ASPI-4020S-6R8	6.8	M	0.125	2.20	1.04	33	6R8
ASPI-4020S-7R5	7.5	M	0.115	1.85	1.08	30	7R5
ASPI-4020S-8R2	8.2	M	0.125	1.75	1.04	27	8R2
ASPI-4020S-100	10	M	0.165	1.60	0.90	26	100
ASPI-4020S-120	12	M	0.175	1.50	0.88	26	120
ASPI-4020S-150	15	M	0.230	1.35	0.77	24	150
ASPI-4020S-220	22	M	0.350	1.05	0.62	15	220
ASPI-4020S-270	27	M	0.545	1.02	0.50	14	270
ASPI-4020S-330	33	M	0.550	0.85	0.49	11	330
ASPI-4020S-390	39	M	0.650	0.82	0.46	11	390
ASPI-4020S-430	43	M	0.660	0.77	0.45	10	430
ASPI-4020S-470	47	M	0.710	0.74	0.44	10	470
ASPI-4020S-510	51	M	0.750	0.70	0.42	10	510
ASPI-4020S-560	56	M	0.800	0.66	0.41	10	560
ASPI-4020S-620	62	M	0.900	0.65	0.39	9.6	620
ASPI-4020S-680	68	M	1.060	0.61	0.36	7.7	680
ASPI-4020S-750	75	M	1.160	0.70	0.35	7.7	750
ASPI-4020S-820	82	M	1.170	0.50	0.34	7.2	820
ASPI-4020S-101	100	M	1.550	0.48	0.31	6.3	101

### Test Conditions:

- Ambient Temperature: 20±15°C
- Relative Humidity: 65%±20%
- Air Pressure: 86KPa to 106KPa

Inductance (L): WK3260B LCR meter or equivalent, 100kHz, 1Vrms

Direct Current Resistance (DCR): HIOKI 3540 or equivalent

Saturation Current (Isat): WK3260B LCR meter or equivalent

Isat: Based on inductance change ( $\Delta L/L_o$  : ≤-30%)

Temperature rise current (Irms): Electric Power, Electric current meter, Thermometer

Irms: Based on temperature rise ( $\Delta T$  : 40 °C TYP. )

ABRACON IS  
ISO9001:2008  
CERTIFIED



**ABRACON**  
CORPORATION

Visit [www.abracon.com](http://www.abracon.com) for Terms & Conditions of Sale

30332 Esperanza, Rancho Santa Margarita, California 92688

tel 949-546-8000 | fax 949-546-8001 | [www.abracon.com](http://www.abracon.com)

Revised: 03.07.13

# Wire Wound Magnetically Shielded SMD Power Inductor



4.0 x 4.0 x 2.0 mm

ASPI-4020S

**Pb** | RoHS/RoHS II Compliant

## ELECTRICAL CHARACTERISTICS CURVES

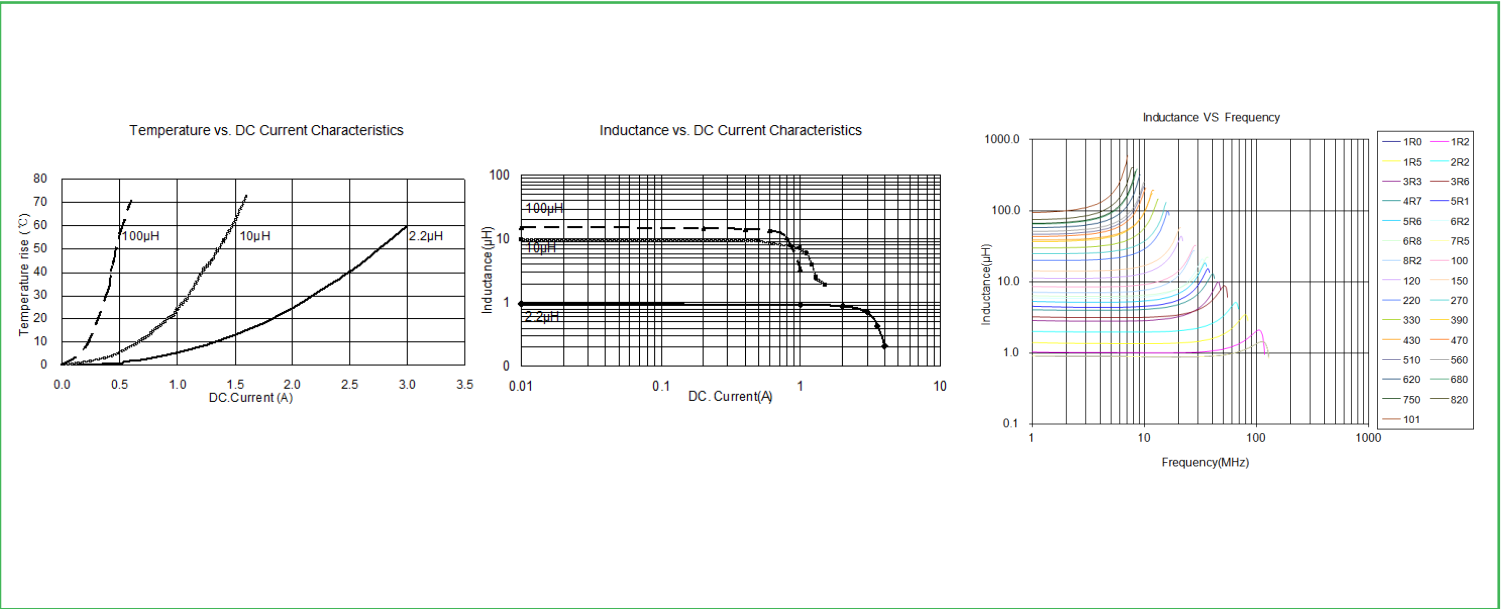

## PART IDENTIFICATION:

ASPI-4020S - [ ] - [ ]

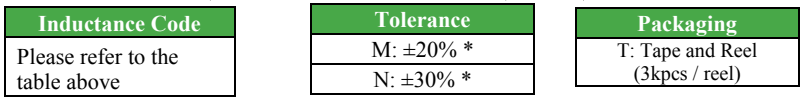

**Inductance Code**  
Please refer to the table above

**Tolerance**  
M:  $\pm 20\%$  \*  
N:  $\pm 30\%$  \*

**Packaging**  
T: Tape and Reel (3kpcs / reel)

\*M for 3.3 $\mu$ H~100 $\mu$ H  
\*N for 1.0 $\mu$ H~2.2 $\mu$ H

## OUTLINE DIMENSIONS:

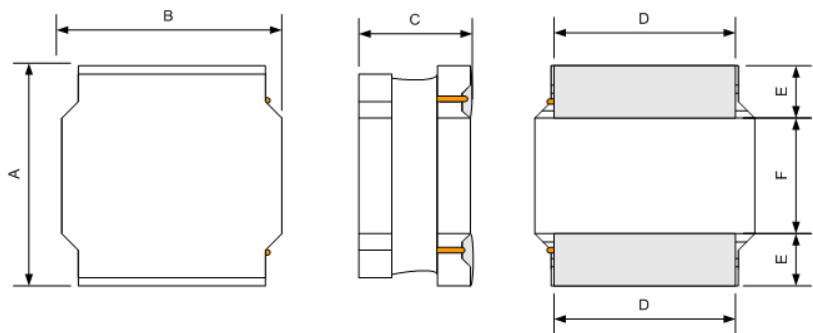

### Recommended Land Pattern

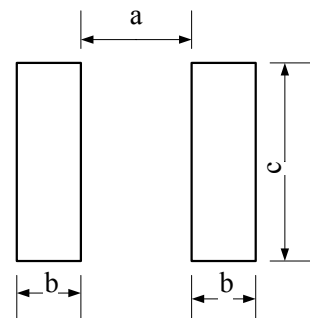

A	B	C Max.	D	E	F	a Typ.	b Typ.	c Typ.
4.0 $\pm$ 0.2	4.0 $\pm$ 0.2	2.0	3.3 $\pm$ 0.2	0.95 $\pm$ 0.2	2.1 $\pm$ 0.2	1.9	1.1	3.7

Dimensions: mm



Visit [www.abracon.com](http://www.abracon.com) for Terms & Conditions of Sale  
 30332 Esperanza, Rancho Santa Margarita, California 92688  
 tel 949-546-8000 | fax 949-546-8001 | [www.abracon.com](http://www.abracon.com)

Revised: 03.07.13

# Wire Wound Magnetically Shielded SMD Power Inductor



4.0 x 4.0 x 2.0 mm

ASPI-4020S

**Pb** | RoHS/RoHS II Compliant

## Materials

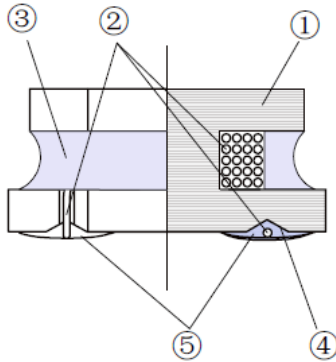

No	Components	Material
1	Ferrite Core	Ni-Zn Ferrite
2	Wire	Polyurethane System enameled copper wire
3	Magnetic Glue	Epoxy resin and magnetic powder
4	Plating Electrodes	Plating: Ag/Ni/Sn
5	Outer Electrodes	Top surface solder coating: Sn96.5%/Ag3%/Cu0.5%

## REFLOW PROFILE:

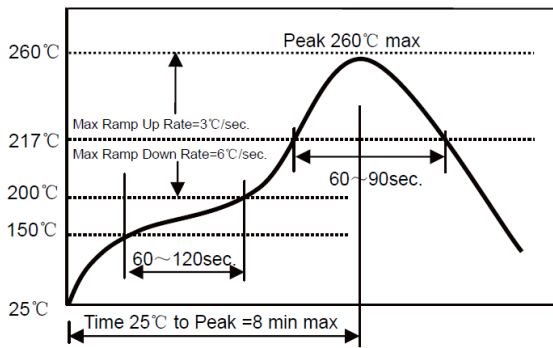

- Δ Preheat condition: 150 ~ 200°C / 60~120sec.
- Δ Allowed time above 217°C: 60~90sec.
- Δ Max temp: 260°C
- Δ Max time at max temp: 5sec.
- Δ Solder paste: Sn/3.0Ag/0.5Cu
- Δ Allowed Reflow time: 2x max

## TAPE & REEL:

T: 3,000pcs / reel

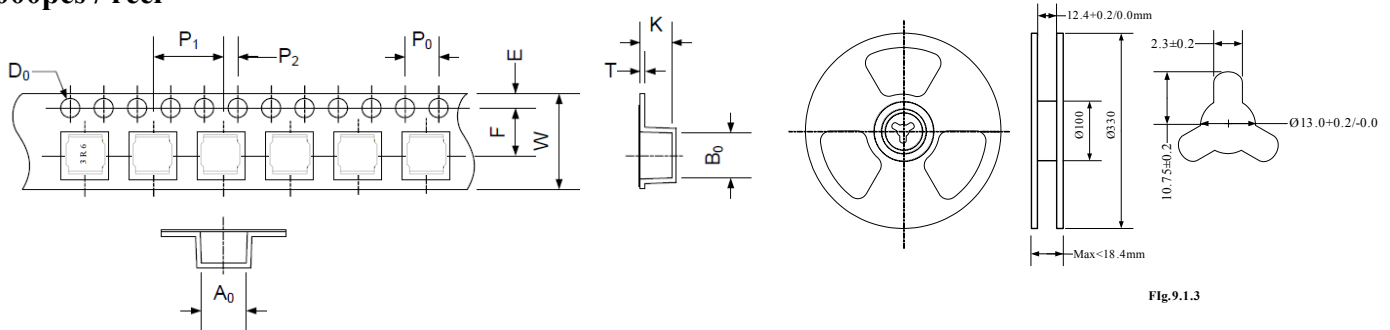

A0	B0	W	E	F	P0	P1	P2	D0	T	K
4.3±0.1	4.3±0.1	12.0±0.3	1.75±0.1	5.5±0.1	4.0±0.1	8.0±0.1	2.0±0.1	1.5+0.1/-0.0	0.4±0.03	2.4±0.1

### Storage Conditions

- a. To maintain the solderability of terminal electrodes and to keep the packing material in good condition, temperature and humidity in the storage area should be controlled.
- b. Recommended conditions: -10°C ~ +40°C, 70% RH (Max.)
- c. Even under ideal storage conditions, solderability of products electrodes may decrease as time passes. For this reason, product should be used with one year from the time of delivery.
- d. In case of storage over 12 months, solderability shall be checked before actual usage.

**Dimensions: mm**

**ATTENTION:** Abracon Corporation's products are COTS – Commercial-Off-The-Shelf products; suitable for Commercial, Industrial and, where designated, Automotive Applications. Abracon's products are not specifically designed for Military, Aviation, Aerospace, Life-dependant Medical applications or any application requiring high reliability where component failure could result in loss of life and/or property. For applications requiring high reliability and/or presenting an extreme operating environment, written consent and authorization from Abracon Corporation is required. Please contact Abracon Corporation for more information.

ABRACON IS  
ISO9001:2008  
CERTIFIED



Visit [www.abracon.com](http://www.abracon.com) for Terms & Conditions of Sale **Revised: 03.07.13**  
30332 Esperanza, Rancho Santa Margarita, California 92688  
tel 949-546-8000 | fax 949-546-8001 | [www.abracon.com](http://www.abracon.com)

# Mouser Electronics

Authorized Distributor

Click to View Pricing, Inventory, Delivery & Lifecycle Information:

## ABRACON:

[ASPI-4020S-1R2N-T](#) [ASPI-4020S-620M-T](#) [ASPI-4020S-7R5M-T](#) [ASPI-4020S-680M-T](#) [ASPI-4020S-2R2N-T](#) [ASPI-4020S-220M-T](#) [ASPI-4020S-750M-T](#) [ASPI-4020S-5R6M-T](#) [ASPI-4020S-270M-T](#) [ASPI-4020S-510M-T](#) [ASPI-4020S-100M-T](#) [ASPI-4020S-5R1M-T](#) [ASPI-4020S-430M-T](#) [ASPI-4020S-101M-T](#) [ASPI-4020S-150M-T](#) [ASPI-4020S-6R2M-T](#) [ASPI-4020S-820M-T](#) [ASPI-4020S-120M-T](#) [ASPI-4020S-1R0N-T](#) [ASPI-4020S-8R2M-T](#) [ASPI-4020S-1R5N-T](#) [ASPI-4020S-390M-T](#) [ASPI-4020S-330M-T](#) [ASPI-4020S-6R8M-T](#) [ASPI-4020S-470M-T](#) [ASPI-4020S-560M-T](#) [ASPI-4020S-3R3M-T](#) [ASPI-4020S-4R7M-T](#) [ASPI-4020S-3R6M-T](#)