



WINSTAR Display Co.,Ltd.
華凌光電股份有限公司



Winstar Display Co., LTD

華凌光電股份有限公司

WEB: <https://www.winstar.com.tw> E-mail: sales@winstar.com.tw



SPECIFICATION

CUSTOMER : _____

MODEL NO. : WLOF0007000A8GAAASB00

<p>APPROVED BY: (FOR CUSTOMER USE ONLY)</p>	
---	--

SALES BY	APPROVED BY	CHECKED BY	PREPARED BY

VERSION	DATE	REVISED PAGE NO.	SUMMARY
G	2021/04/29	25	Add OD 0x2104 of Mode info

TFT Display Inspection Specification: <https://www.winstar.com.tw/technology/download.html>

Precaution in use of TFT module: <https://www.winstar.com.tw/technology/download/declaration.html>

RECORDS OF REVISION			DOC. FIRST ISSUE
VERSION	DATE	REVISED PAGE NO.	SUMMARY
0	2020/09/04		First issue
A	2020/10/22	7	Modify the Product information TP value to With TP
B	2020/10/27	7	Modify General information table value
C	2020/11/06	6	Modify data in Summary.
D	2020/12/03	8	Modify Contour Drawing
E	2021/02/08	19	Add firmware new Object type.
F	2021/04/19	25	Modify the Buzzer OD and add the new OD of Background, Backlight, Page
G	2021/04/29	25	Add OD 0x2104 of Mode info

Contents

1. Smart Display Classification Information
2. Summary
3. Product information
4. Contour Drawing
5. Absolute Maximum Ratings
6. Electrical Characteristics
7. BOM
8. Block diagram
9. Interface
10. Reliability
11. Product inspection check list
12. Display Usage
13. Example Screen Layout (Industry application)
14. References

1. Smart Display Classification Information

W	L	OF	000700	0A8	G	A	AA	S	B	00
①	②	③	④	⑤	⑥	⑦	⑧	⑨	⑩	⑪

①	W: WINSTAR products									
②	Type: L:Standard K:Customization									
③	Display Type:	Standard:	0H: Character STN 0X: Graphic STN (TAB/COF) 0F: TFT EH: Character OLED EX: OLED (TAB/COF)	0G: Graphic STN 0P: Graphic STN (COG) EG: Graphic OLED EP: OLED (COG)						
		Customization:	DH: Character DN: Graphic ED: OLED	DG: Graphic STN 0J: TFT						
④	Display size: (diagonal) / Display format: (resolution)	Character STN:	e.g., 8x1: 000801 16x2: 001602 24x4: 002404							
		Graphic STN:	e.g., 128x64: 012864 320x240: 320240							
		TFT Size (inch):	000096-0.96" / 000350-3.5" / 000430-4.3" / 000570-5.7" 000700-7.0" / 000800-8.0" / 001020-10.2" / 001210-12.1" (The last two digits are two digits after the decimal point)							
	OLED:	e.g., 128x64: 012864 Customization: 0001XX								
⑤	Serial No:	0A1 ~ 0ZZ	Customization STN: 000							
⑥	Touch Panel Type:	N: Without TP T: RTP G: CTP								
⑦	Model Interface:	A: CAN B: Bluetooth C: Controller Specified D: RS485 E: RS232 F: USART G: Logic I/O	H: HDMI R: Memory Specified N: Ethernet J: Analog I/O K: USB L: WIFI M: Zigbee	X: Combined Y: Proprietary interface						
⑧	Interface Serial No.:	AA ~ ZZ								
⑨	Control Category:	S: Smart Display N: Non-specified								
⑩	Special Code:	A → Generic B → Industrial C → Automotive D → Medical								
⑪	Model code:	00 ~ ZZ								

2. Summary

7 Inch Smart Display (CAN series) Features

1. +12V power supply input, the power consumption is around 6W.
2. Self testing after booting function.
3. CAN bus communication interface.
4. Support CANopen negotiation. Default baud rate is 250KB.
5. Embedded FLASH memory, storing Font and Object Dictionary.
6. Support capacitive touch panel (CTP).
7. Smart Display scenario is slave device display and action from Master Device instruction.
8. Embedded buzzer controlled by Master Device.
9. Demo set HOST can be used on multiple platforms, such as Computer (with USB to CAN Dongle), MCU, Raspberry Pi (with PiCAN2).

3. Product information

3.1 Mechanical Data

Item	Standard Value	Unit
LCD panel	169.9(W) x 103.4(H) x 5.6(D)	mm
PCB	184.1(W) x 102.6(H) x 1.6(D)	mm
Housing outline	184.1(W) x 102.6(H) x 21.85(D)	mm

3.2 General information

Item	Standard Value	Unit
Operating voltage	12	Vdc
Communication Interface	CAN bus differential ± 3.3	Vpp
LCD display size	7.0	inch
Dot Matrix	1024 x RGBx600(TFT)	dot
Module dimension	169.9(W) x 103.4(H) x 5.6(D)	mm
Active area	154.2144 x 85.92	mm
Dot pitch	0.1506 x 0.1432	mm
LCD type	LED, Normally White	
View Direction	85/85/85/85	
Aspect Ratio	16:9	
With /Without TP	With CTP	
Surface	Anti-Glare	

4. Contour Drawing

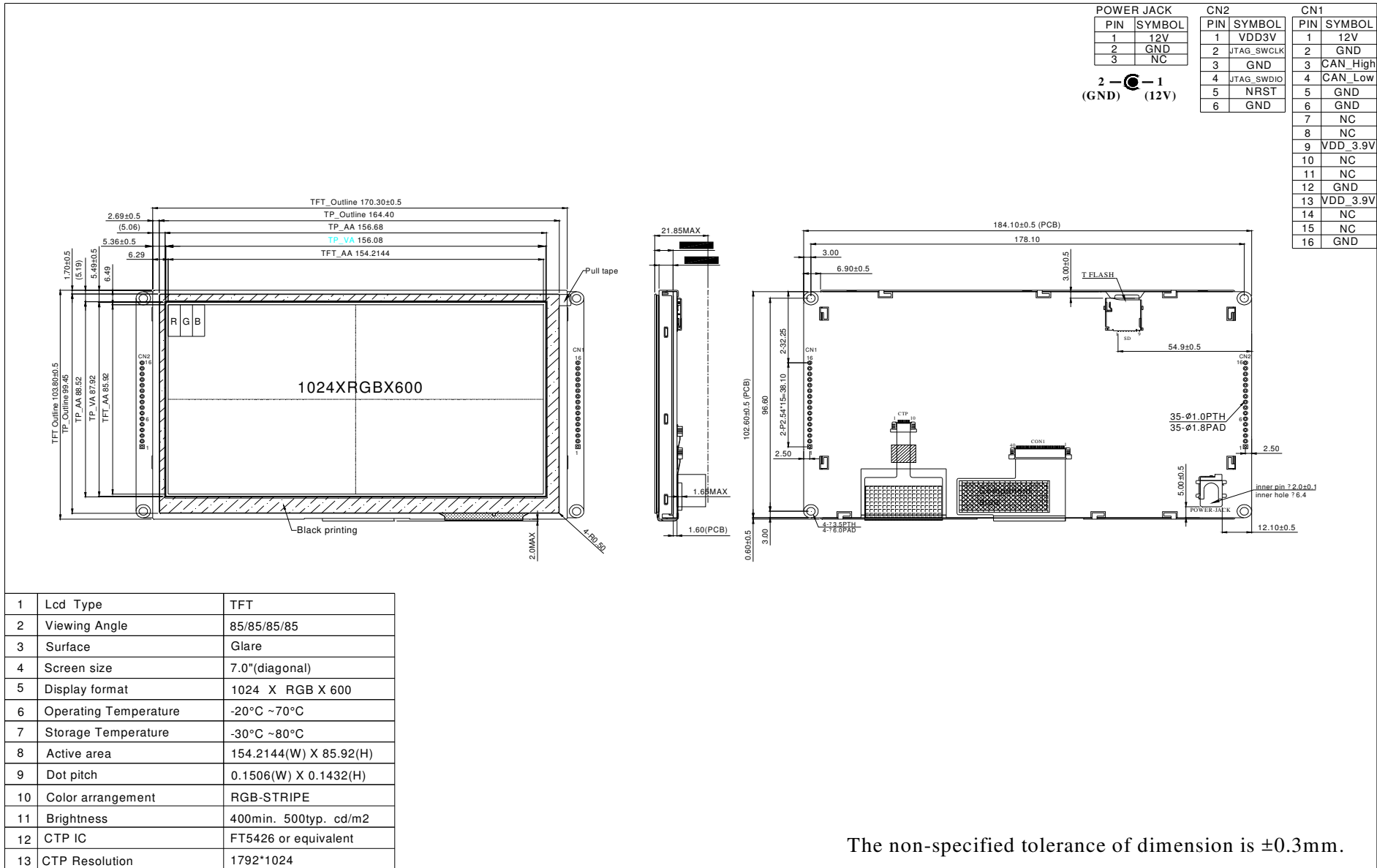

5. Absolute Maximum Ratings

Item	Symbol	Min	Typ	Max	Unit
Operating Temperature	TOP	-20	—	+70	°C
Storage Temperature	TST	-30	—	+80	°C

Note: Device is subject to be damaged permanently if stresses beyond those absolute maximum ratings listed above

1. Temp. $\leq 60^{\circ}\text{C}$, 90% RH MAX. Temp. $> 60^{\circ}\text{C}$, Absolute humidity shall be less than 90% RH at 60°C

6. Electrical Characteristics

6.1. Operating conditions:

Item	Symbol	Condition	Min	Typ	Max	Unit
Supply Voltage For Analog	VCI	—	11.4	12	12.6	V
Interface Operation Voltage	IOVCC	—	3.234	3.30	3.367	V
Supply LCM current	ICI(mA)	-	-	-	502	mA

6.2. LED driving conditions:

Parameter	Symbol	Min.	Typ.	Max.	Unit	Remark
LED current		-	240	-	mA	
Power Consumption		-	4608	-	mW	
LED voltage	VBL+	16.8	19.2	21.0	V	Note 1
LED Life Time		-	50,000	-	Hr	Note 2,3,4

Note 1 : There are 1 Groups LED

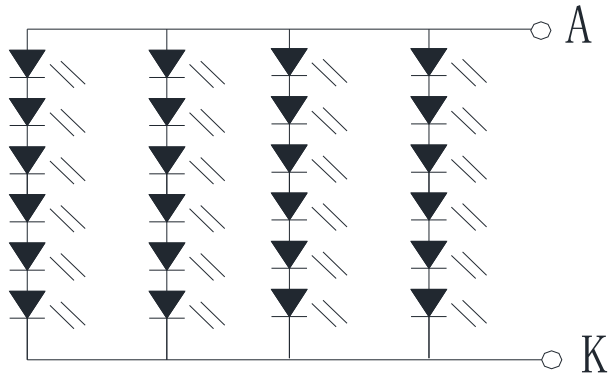

Backlight 24LED Circuit

Note 2 : Ta = 25 °C

Note 3 : Brightness to be decreased to 50% of the initial value

Note 4 : The single LED lamp case

7. BOM

Item	Description	Remark
LCM	WF70A8TYAHLNG0#	
PCBA	Design part for SMART070	

8. Block diagram

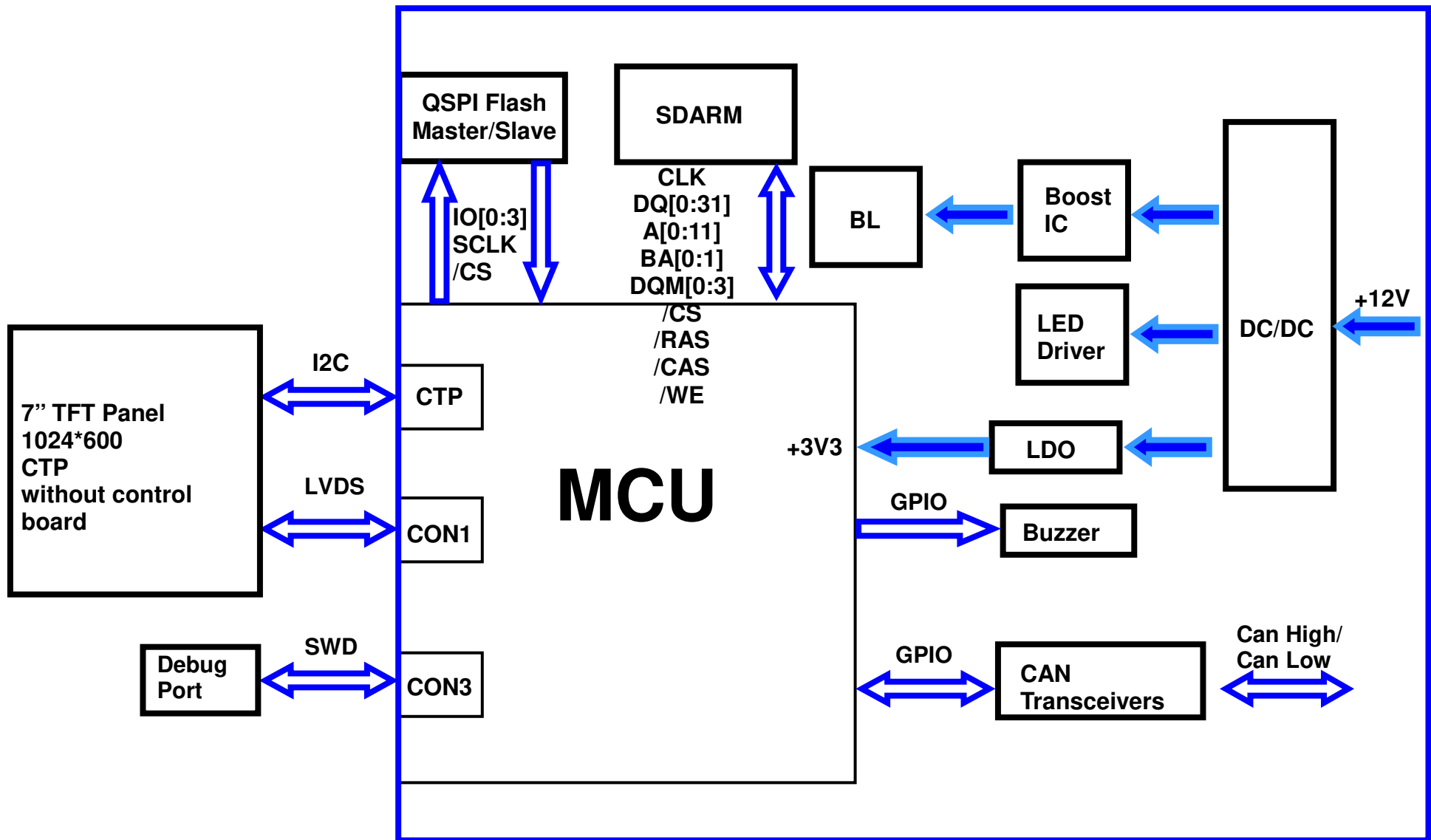

9. Interface

CON1 definition:

Pin	Symbol	Function	Remark
1	+12V	Power supply 12V input	Input
2	GND	Power supply GND input	Input
3	CAN_High	CAN bus D+	I/O
4	CAN_Low	CAN bus D-	I/O
5	GND	Power supply GND input	Input
6	GND	Power supply GND input	Input
7	–	–	–
8	–	–	–
9	VDD_3.9V	3.9V	Power
10	–	–	–
11	–	–	–
12	GND	GND	GND
13	VDD_3.9V	3.9V	Power
14	–	–	–
15	–	–	–
16	GND	GND	GND

CON2 definition:

Pin	Symbol	Function	Remark
1	VDD3V	3.3V power for JTAG interface	Output
2	JTAG_SWCLK	CLK pin for JTAG interface	Input
3	GND	GND for JTAG interface	Output
4	JTAG_SWDIO	Data pin for JTAG interface	I/O
5	NRST	Reset pin for JTAG interface	Input
6	GND	GND	Output
7			
8			
9			
10			
11			
12			
13			
14			
15			
16			

10. Reliability

Content of Reliability Test (Wide temperature, -20°C~70°C)

Environmental Test			
Test Item	Content of Test	Test Condition	Note
High Temperature storage	Endurance test applying the high storage temperature for a long time.	80°C 96hrs	2
Low Temperature storage	Endurance test applying the low storage temperature for a long time.	-30°C 96hrs	1,2
High Temperature Operation	Endurance test applying the electric stress (Voltage & Current) and the thermal stress to the element for a long time.	70°C 96hrs	—
Low Temperature Operation	Endurance test applying the electric stress under low temperature for a long time.	-20°C 96hrs	1
High Temperature/ Humidity Operation	The module should be allowed to stand at 40°C,90%RH max	40°C,90%RH 96hrs	1,2
Thermal shock resistance	The sample should be allowed stand the following 10 cycles of operation <div style="text-align: center;"> <p style="margin: 0;">-20°C 25°C 70°C</p> <p style="margin: 0;">30min 5min 30min</p> <p style="margin: 0;">1 cycle</p> </div>	-20°C/70°C 10 cycles	—
Vibration test	Endurance test applying the vibration during transportation and using.	Total fixed amplitude : 1.5mm Vibration Frequency : 10~55Hz One cycle 60 seconds to 3 directions of X,Y,Z for Each 15 minutes	3
Static electricity test	Endurance test applying the electric stress to the terminal.	VS=±600V(contact) ,±800v(air), RS=330Ω CS=150pF 10 times	—

Note1: No dew condensation to be observed.

Note2: The function test shall be conducted after 4 hours storage at the normal Temperature and humidity after remove from the test chamber.

Note3: The packing have to including into the vibration testing.

11. Product inspection check list

Check samples by meter V_{IN} , I_{system}

Item	No 1	No 2	No 3	Note
V_{IN} (V)	12.1	12.1	12.1	
$I_{System}(mA)$	0.55	0.548	0.538	

Check sample Reliability Test

Item	Result	Note
Thermal shock	—	-20°C/70°C 20 cycles
High Temperature Operation	—	70°C 96hrs
Low Temperature Operation	—	-20°C 96hrs
Static electricity test	—	VS=±600V(contact),±800v(air), RS=330Ω CS=150pF 10 times
Vibration test	—	Total fixed amplitude : 1.5mm Vibration Frequency : 10~55Hz One cycle 60 seconds to 3 directions of X,Y,Z for Each 15 minutes

- Prepare sets for testing

12. Display Usage

Functional description

Smart Display can be used to display the coordinate, status and data information provided by the connected HOST device. Customers can configure the position coordinates they want to display in normal operation mode (COB-ID = 0x7B).

The Display is designed to be easily connected to a controller network, and to operate with minimum setup or knowledge of the SDO configuration on the controllers.

Splash Screen

The default splash image is shown below.

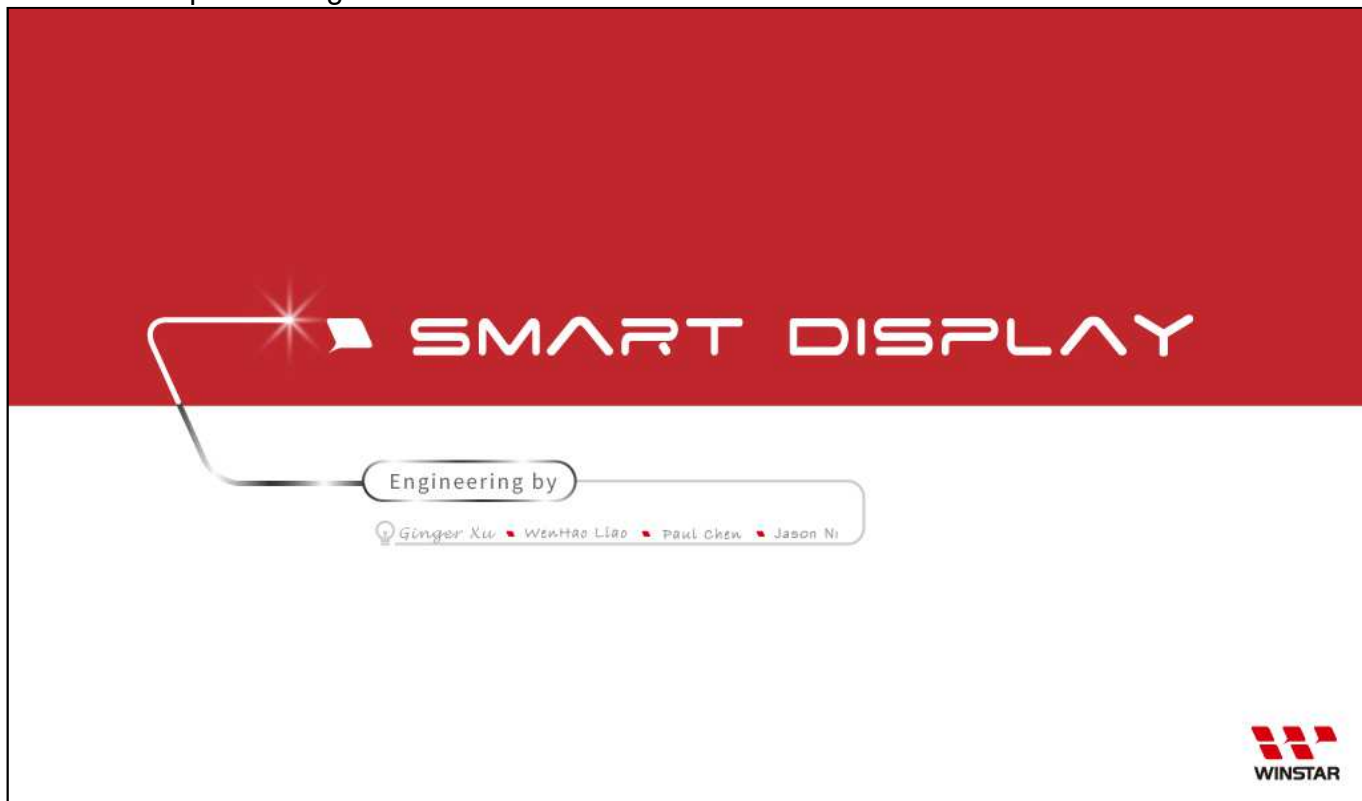

- ✓ This product is produced as a generic product. If you require a custom splash image for your application, contact us to discuss.

Acquisition of Displayed Data

The Smart Display can acquire the data that it displays either using the CANopen SDO protocol, or using the CANopen PDO protocol.

On Pre-operational mode, customers can set the coordinates of objects through SDO; On operational mode, customers can send data of objects through PDO.

Configuring the Display

Winstar Smart Display CAN series offers an out-of-the-box CANopen development experience that will lower customers' development costs and speed time-to-market expectations.

The Smart Display can use wide-temperature are designed to support control applications in harsh operating conditions, which designed to be connected to a variety of different situation combinations, such as automotive, marine, power generation and oil-and-gas.

The Smart Display comes with standard UI objects to get customers project off the ground quickly. If customers need custom UI objects support, our engineers are here to help. Send over your contents in PNG/JPG format, we will send over a new set of UI objects within 3~5 working days.

The Smart Display is defined as a slave device, which is controlled by master device via CAN bus command to render display content on the display screen and return touch event data with protocol objects.

Node ID when Standalone

If the display is powered up standalone, the node id will default to 0x7B.

Configuring the Main Screen

The screen on the display is 1024 x 600 pixels.

The co-ordinate system used to specify the location of an item on the screen is shown in the diagram below. The coordinates are (x,y) where 'x' is the horizontal offset from the left, and 'y' is the vertical offset from the top.

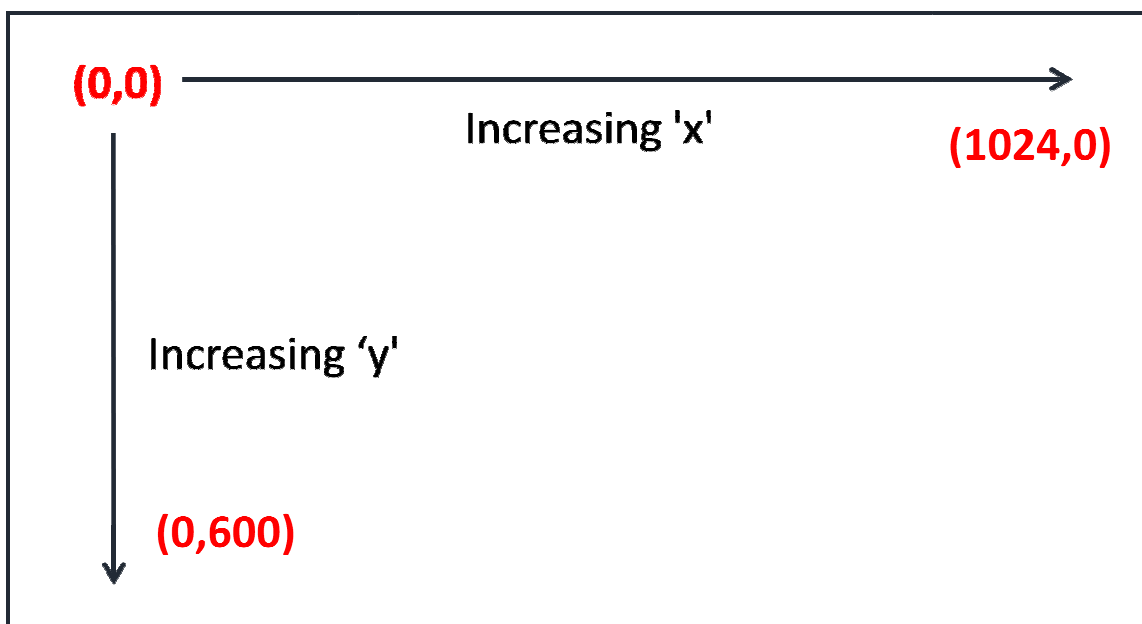

Item Object Dictionary

There are 10 objects entries which are for configuration of the items that can be displayed on the screen. These are at location 0x2000 to 0x2009. Each object fully defines one screen item.





Each item has a set of sub-index items which are used to control the coordinate of the item. The exact functionality varies depending on the type of item selected. The template object is shown below:



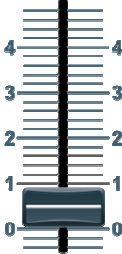

Object List(0x2000 to 0x2009)

Object Index 0x2000 to 0x2009	Name	type	Description
Sub 0	Number of Entries	UNSIGNED8	9
Sub 1	Type	UNSIGNED8	style of Object
Sub 2	Reserve		
Sub 3	X position	INTEGER16	The object's X position
Sub 4	Y position	INTEGER16	The object's Y position
Sub 5	Number of Style	INTEGER16	The photo of style
Sub 6	Reserve		
Sub 7	Value 1	UNSIGNED16	Data to smart display from HOST
Sub 8	Value 2	UNSIGNED16	Data from smart display to HOST
Sub 9	Reserve		

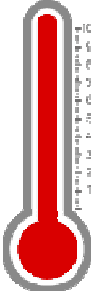
Sub 1 – Type

The item type is selected according to the table below:

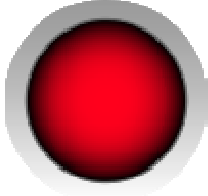

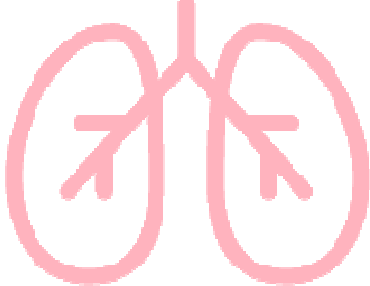
Data	Description	Example Image
0	No Item This entry is not used	
1	Reserve	
2	Gauge	
3	Reserve	
4	Button	
5	Toggle Button	
6	Vertical Slider	
7	Horizontal Slider	
8	Reserve	
9	Temperature	







10	Battery	
11	Graph	
12	Indicator	
13	CircleProgress	
14	ImageProgress	
15	Reserve	
16	Animated Image	
17	Number String	65535
18	Text String	ABC

Sub 3&4 – x and y position

Each item is drawn on screen by setting a draw rectangle. This rectangle is a bounding rectangle sized to fully enclose the item that is being drawn. The co-ordinates specify the position of the top left of this bounding rectangle.

Sub 5 –Number of Style
 Various types of icons

Gauge	icon
0	
1	
2	
3	
4	
5	
6	

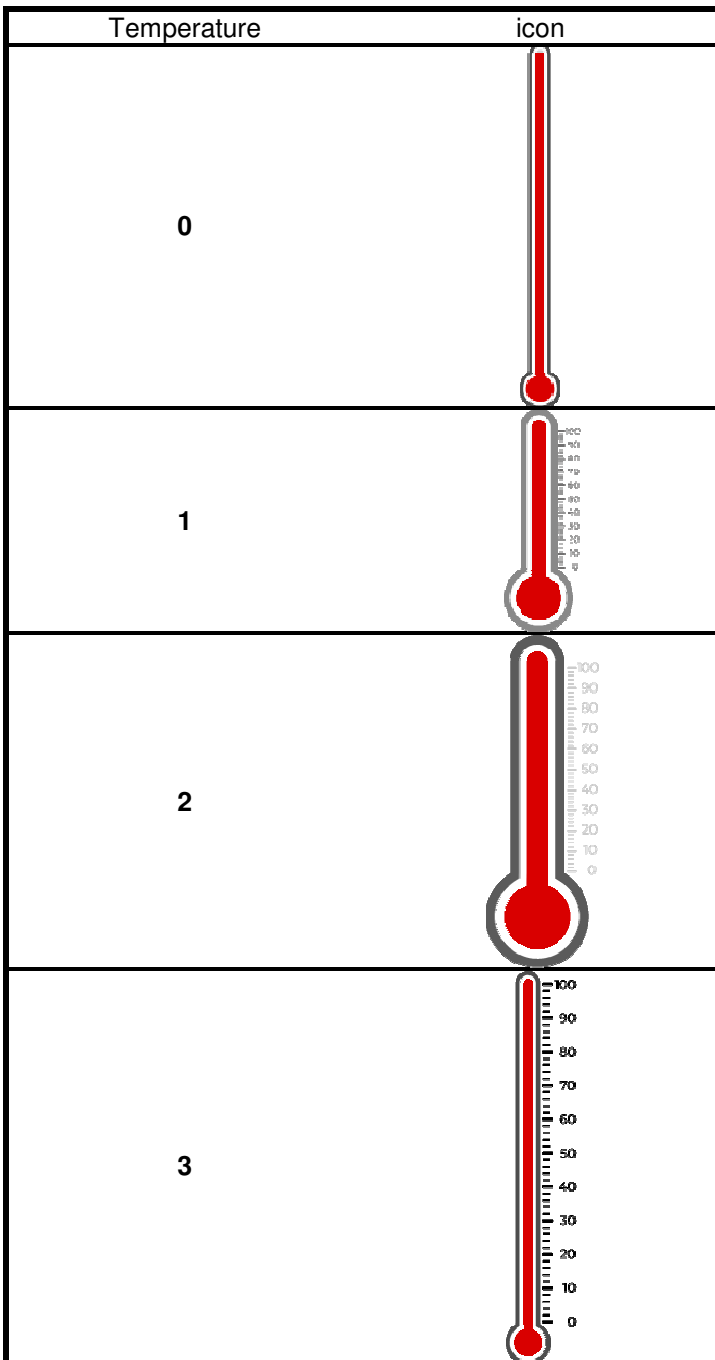
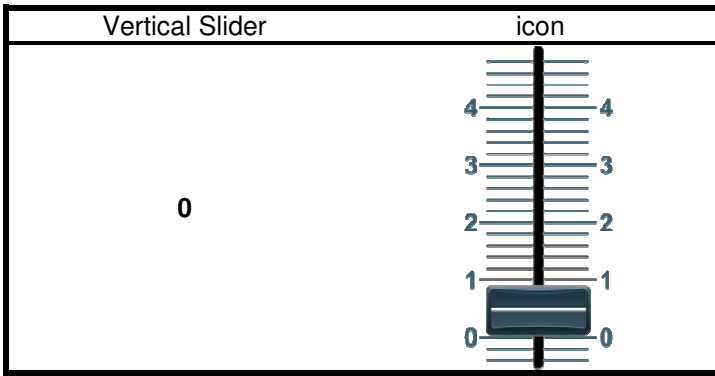

Button	icon
0	
1	
2	
3	
4	
5	
6	



Battery	icon
0	
1	
2	

Indicator	icon
0	
1	

CircleProgress	icon
0	
1	

ImageProgress	icon
0	
1	

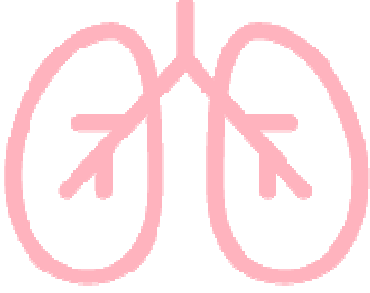
Animated Image	icon
0	

Number String	icon
0	65535
1	65535
2	65535

Text String	icon
0	ABC
1	ABC
2	ABC

Sub 7&8 –Data send and receive

HOST sends numeric data to Sub 7 to control Smart Display objects another HOST receives numerical data from Sub8.

HOST can be used on multiple platforms, such as **Computer, MCU, Raspberry Pi(with PiCAN2).**

Background(0x2100)

Object Index 0x2100	Name	type	Description
Sub 0	Data	UNSIGNED8	Background of number

Backlight(0x2101)

Object Index 0x2101	Name	type	Description
Sub 0	Data	UNSIGNED8	Value(0~100)

Buzzer(0x2102)

Object Index 0x2102	Name	type	Description
Sub 0	Number of Entries	UNSIGNED8	
Sub 1	Cycle	UNSIGNED8	Number of repetitions
Sub 2	High	UNSIGNED8	High level
Sub 3	Low	UNSIGNED8	Low level
Sub 4	Active	BOOLEAN	'1' is active

Page(0x2103)

Object Index 0x2103	Name	type	Description
Sub 0	Number of Entries	UNSIGNED8	
Sub 1	Count	UNSIGNED8	Return to page number
Sub 2	Index	UNSIGNED8	Jump to number page

Mode(0x2104)

Object Index 0x2104	Name	type	Description
Sub 0	Number of Entries	UNSIGNED8	
Sub 1	Mode	UNSIGNED8	'0x00' enter pre-operation '0x01' enter operation

13. Example Screen Layout (Industry application)

Example Layout

The screen layout described in this section is intended to demonstrate the settings of screen items that can be used in an industry application situation.

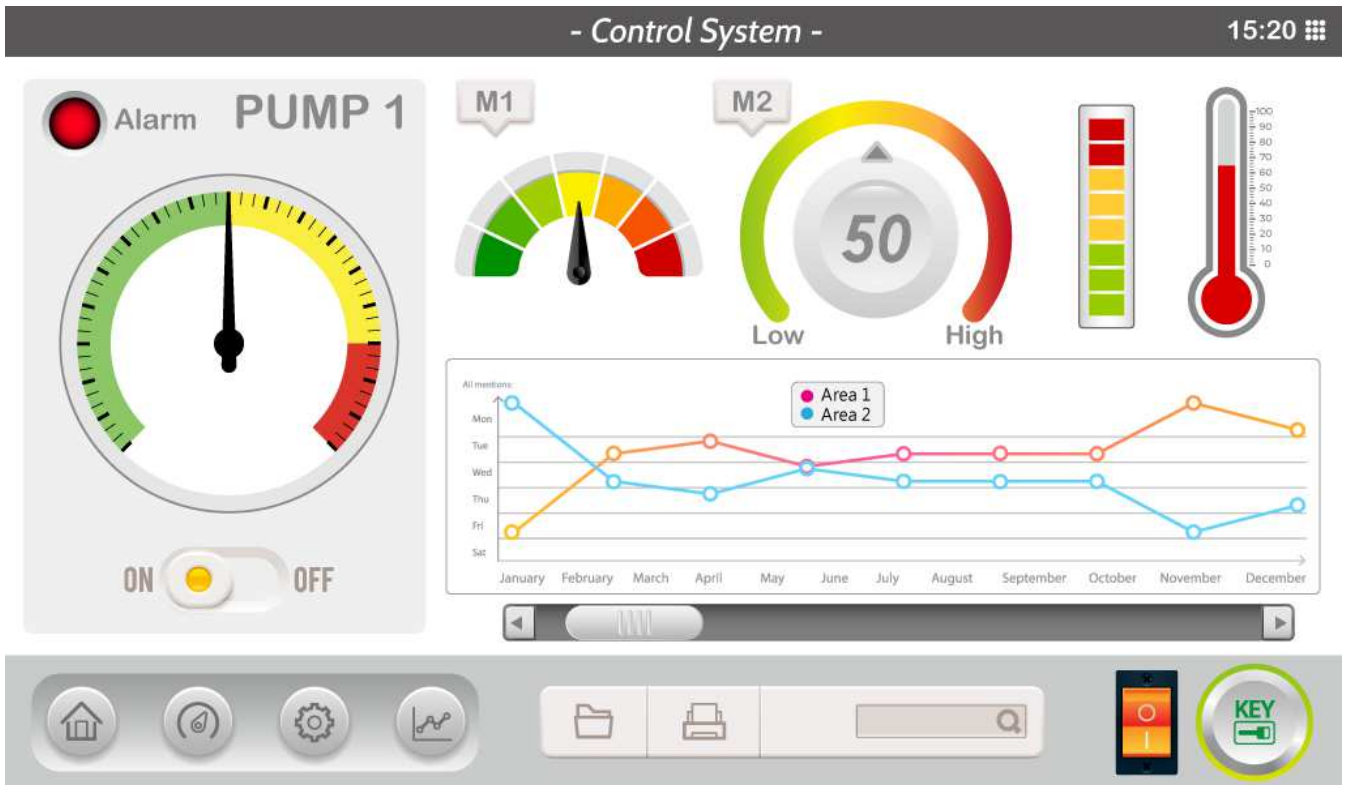

14. References