



WINSTAR Display Co.,Ltd.
華凌光電股份有限公司



Winstar Display Co., LTD

華凌光電股份有限公司

WEB: <https://www.winstar.com.tw> E-mail: sales@winstar.com.tw



SPECIFICATION

CUSTOMER : _____

MODULE NO.: WF43UTIAEDNNO#

<p>APPROVED BY:</p> <p>(FOR CUSTOMER USE ONLY)</p>	<p>PCB VERSION: _____</p> <p>DATA: _____</p>
---	--

SALES BY	APPROVED BY	CHECKED BY	PREPARED BY
			葉虹蘭
ISSUED DATE: 2018/11/22			

This TFT Display item is for Economical Version TFT LCM Inspection Specification:

<https://www.winstar.com.tw/technology/download.html>

RECORDS OF REVISION			DOC. FIRST ISSUE
VERSION	DATE	REVISED PAGE NO.	SUMMARY
0	2018/05/04		First issue
A	2018/05/15		Correct LCD type.
B	2018/11/06		Add Uniformity
C	2018/11/22		Add TFT Driver IC Upgrade AC CHARATERISTICS & DC CHARATERISTICS

Contents

1.Module Classification Information

2.Summary

3.General Specification

4.Absolute Maximum Ratings

5.Electrical Characteristics

6.DC Characteristics

7.AC Characteristics

8.Optical Characteristics

9.Interface

10.Block Diagram

11.Reliability

12.Contour Drawing

13.Other

1.Module Classification Information

W F 43 U T I A E D N N 0 #
 ① ② ③ ④ ⑤ ⑥ ⑦ ⑧ ⑨ ⑩ ⑪ ⑫ ⑬

①	Brand : WINSTAR DISPLAY CORPORATION											
②	Display Type : F→TFT Type, J→Custom TFT											
③	Display Size : 4.3" TFT											
④	Model serials no.											
⑤	Backlight Type :		F→CCFL, White S→LED, High Light White				T→LED, White Z→Nichia LED, White					
⑥	LCD Polarize Type/ Temperature range/ Gray Scale Inversion Direction		A→Transmissive, N.T, IPS TFT C→Transmissive, N. T, 6:00 ; F→Transmissive, N.T,12:00 ; I→Transmissive, W. T, 6:00 K→Transflective, W.T,12:00 L→Transmissive, W.T,12:00 N→Transmissive, Super W.T, 6:00				Q→Transmissive, Super W.T, 12:00 R→Transmissive, Super W.T, O-TFT V→Transmissive, Super W.T, VA TFT W→Transmissive, Super W.T, IPS TFT X→Transmissive, W.T, VA TFT Y→Transmissive, W.T, IPS TFT Z→Transmissive, W.T, O-TFT					
⑦	A : TFT LCD B : TFT+SCREW HOLES+CONTROL BOARD C : TFT+ SCREW HOLES +A/D BOARD D : TFT+ SCREW HOLES +A/D BOARD+CONTROL BOARD E : TFT+ SCREW HOLES +POWER BOARD					F : TFT+CONTROL BOARD G : TFT+ SCREW HOLES H : TFT+D/V BOARD I : TFT+ SCREW HOLES +D/V BOARD J : TFT+POWER BD						
⑧	Resolution:											
	A	128160	B	320234	C	320240	D	480234	E	480272	F	640480
	G	800480	H	1024600	I	320480	J	240320	K	800600	L	240400
	M	1024768	N	128128	P	1280800	Q	480800	R	640320	S	480128
	T	800320	U	8001280	V	176220	W	1280398	X	1024250	Y	1920720
	Z	800200	2	1024324	3	7201280	4	19201200	5	1366768	6	1280320
⑨	D: Digital L : LVDS M:MIPI											
⑩	Interface:											
	N	Without control board			A	8Bit		B	16Bit		H	HDMI
	I	I2C Interface			R	RS232		S	SPI Interface		U	USB
⑪	TS:											
	N	Without TS			T	Resistive touch panel			C	Capacitive touch panel (G-F-F)		
	G	Capacitive touch panel (G-G)					C1	Capacitive touch panel (G-F-F)+OCA				
	C2	Capacitive touch panel (G-F-F)+OCR					G1	Capacitive touch panel (G-G)+OCA				
	G2	Capacitive touch panel (G-G)+OCR					B	CTP+GG+USB				
⑫	Version: X:Raspberry pi											
⑬	Special Code		#:Fit in with ROHS directive regulations									

2.Summary

TFT 4.3” is a TN transmissive type color active matrix TFT liquid crystal display that use amorphous silicon TFT as switching devices. This module is a composed of a TFT_LCD module, It is usually designed for indusrial application and this module follows RoHs,

3. General Specifications

Item	Dimension	Unit
Size	4.3	inch
Dot Matrix	480 x RGBx272(TFT)	dots
Module dimension	105.4(W) x 67.1(H) x 2.95 (D)	mm
Active area	95.04 x 53.856	mm
Dot pitch	0.066 x 0.198	mm
LCD type	TFT, Normally White, Transmissive	
View Direction	12 o'clock	
Gray Scale Inversion Direction	6 o'clock	
Aspect Ratio	16:9	
TFT Driver IC	ST7282-G4-1L	
Interface	24-bit RGB	
Backlight Type	LED, Normally White	
With /Without TP	Without TP	
Surface	Anti-Glare	

*Color tone slight changed by temperature and driving voltage.

4. Absolute Maximum Ratings

Item	Symbol	Min	Typ	Max	Unit
Operating Temperature	TOP	-20	—	+70	°C
Storage Temperature	TST	-30	—	+80	°C

Note: Device is subject to be damaged permanently if stresses beyond those absolute maximum ratings listed above

1. Temp. $\leq 60^{\circ}\text{C}$, 90% RH MAX. Temp. $> 60^{\circ}\text{C}$, Absolute humidity shall be less than 90% RH at 60°C

5. Electrical Characteristics

5.1. Operating conditions:

Item	Symbol	Condition	Min	Typ	Max	Unit
Supply Voltage For Logic	VCC	—	3.1	3.3	3.5	V
Digital operation current	Icc	—	—	22	33	mA

5.2. LED driving conditions

Item	Symbol	Min	Typ	Max	Unit	Remark
LED current	—	—	40	—	mA	—
Power Consumption	—	—	774	792	mW	—
LED voltage	LED+	16.8	18.6	19.8	V	Note 1
LED Life Time	—	20,000	—	—	Hr	Note 2,3,4

Note 1 : There are 1 Groups LED

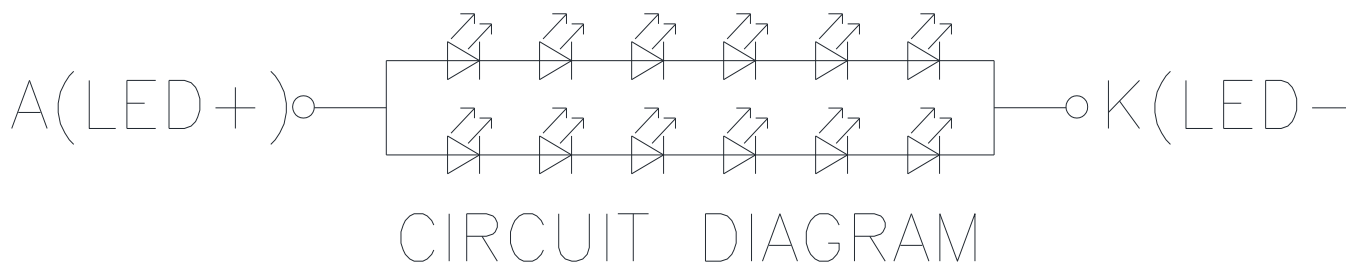

Note 2 : $T_a = 25\text{ }^\circ\text{C}$

Note 3 : Brightness to be decreased to 50% of the initial value

Note 4 : The single LED lamp case

6.DC CHARATERISTICS

Parameter	Symbol	Rating			Unit	Condition
		Min	Typ	Max		
Low level input voltage	V_{IL}	0	-	0.3VCC	V	
High level input voltage	V_{IH}	0.7VCC	-	VCC	V	

7.AC CHARACTERISTICS

7.1. AC Characteristics

AC Electrical Characteristics (VCC= 3.3V, GND= 0V, TA=25°C)

Item	Symbol	Min.	Typ.	Max.	Unit	Conditions
System operation timing						
VCC power source slew time	TPOR	-	-	20	Ms	From 0V to 99% VCC
GRB pulse width	tRSTW	10	50	-	us	R=10Kohm, C=1uF
Input/ Output timing						
CLK pulse duty	Tcw	40	50	60	%	
Hsync width	Thw	2	-	-	DCLK	
Hsync period	Th	55	60	65	us	
Vsync setup time	Tvst	12	-	-	ns	
Vsync hold time	Tvhd	12	-	-	ns	
Hsync setup time	Thst	12	-	-	ns	
Hsync hold time	Thhd	12	-	-	ns	
Data setup time	Tdsu	12	-	-	ns	
Data hold time	Tdhd	12	-	-	ns	
DE setup time	Tdest	10	-	-	ns	
DE setup time	Tdehd	10	-	-	ns	

7.2. AC Timing Diagram

Clock and Data Input Timing Diagram

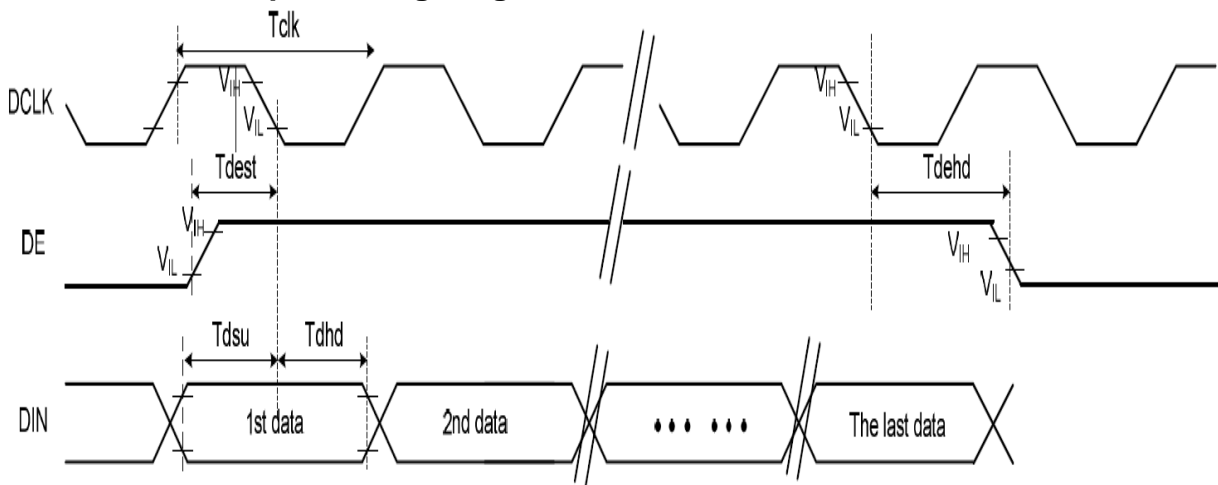

7.3. Parallel DE mode 24-bit RGB Timing Table

Item	Symbol	Min	Typ	Max	Unit	Remark	
CLK frequency	Fclk	8	9	12	MHz		
DCLK Period	Tclk	83	111	125	ns		
HSYNC	Period Time	Th	485	531	598	DCLK	
	Display Period	Thdisp		480		DCLK	
	Back Porch	Thbp	3	43	43	DCLK	By H_Blanking setting
	Front Porch	Thfp	2	8	75	DCLK	
	Pulse Width	Thw	2	4	75	DCLK	
VSYNC	Period Time	Tv	276	292	321	H	
	Display Period	Tvdisp		272		H	
	Back Porch	Tvbp	2	12	12	H	By V_Blanking setting
	Front Porch	Tvfp	2	8	37	H	
	Pulse Width	Tvw	2	4	37	H	

7.4. DE Mode Timing Diagram

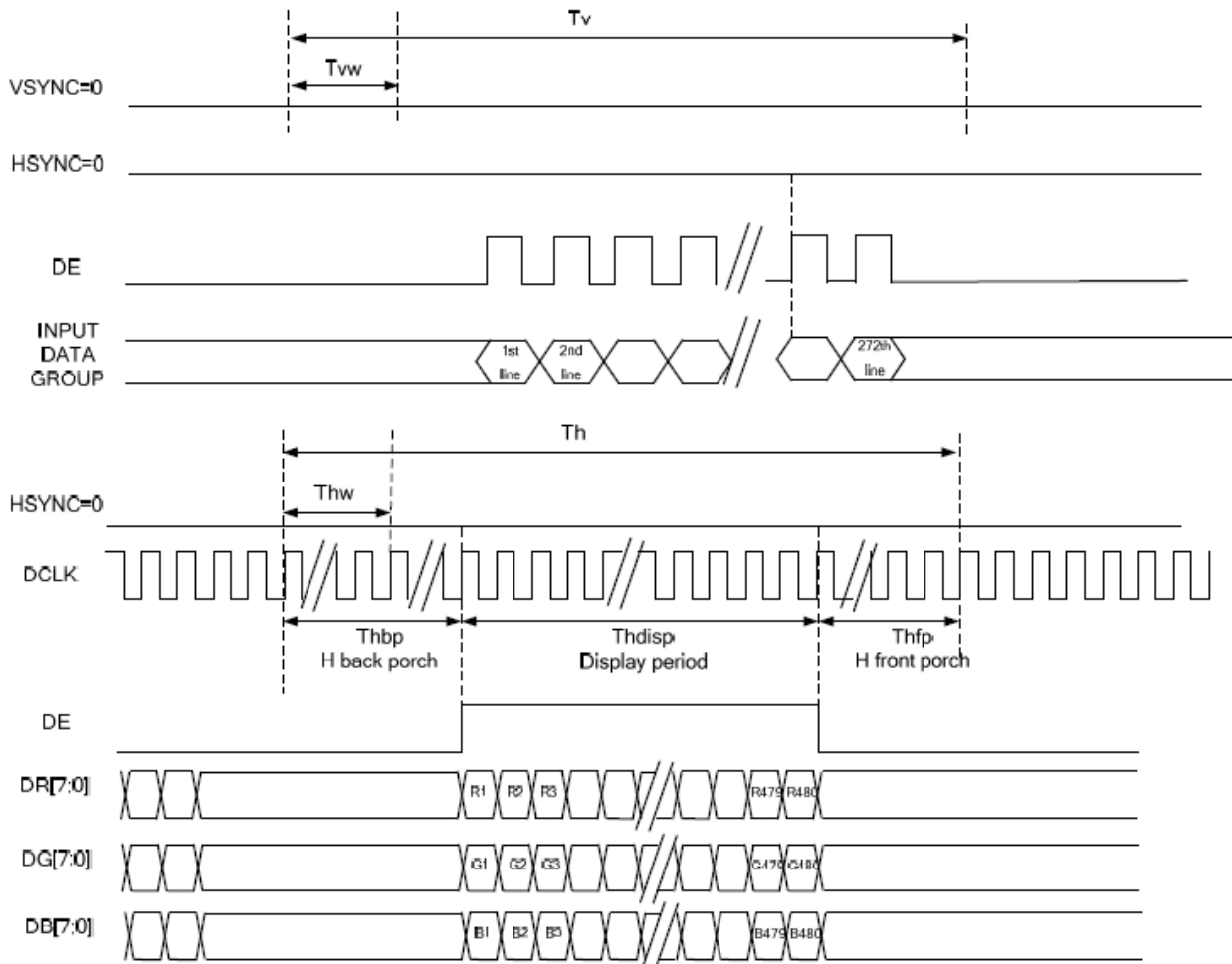

8. Optical Characteristics

Item	Symbol	Condition.	Min	Typ.	Max.	Unit	Remark	
Response time	Tr	$\theta=0^\circ$ 、 $\phi=0^\circ$	-	25	30	ms	Note 3	
	Tf							
Contrast ratio	CR	At optimized viewing angle	-	500	-	-	Note 4	
Color Chromaticity	White	Wx	$\theta=0^\circ$ 、 $\phi=0$	0.26	0.31	0.36	-	Note 2,6,7
		Wy		0.28	0.33	0.38	-	
Viewing angle (Gray Scale Inversion Direction)	Hor.	Θ_R	$CR \geq 10$	-	70	-	Deg.	Note 1
		Θ_L		-	70	-		
	Ver.	Φ_T		-	50	-		
		Φ_B		-	70	-		
Brightness	-	-	500	600	-	cd/m ²	Center of display	
Uniformity	(U)	-	75	-	-	%	Note 5	

Ta=25±2°C, IL=40mA

Note 1: Definition of viewing angle range

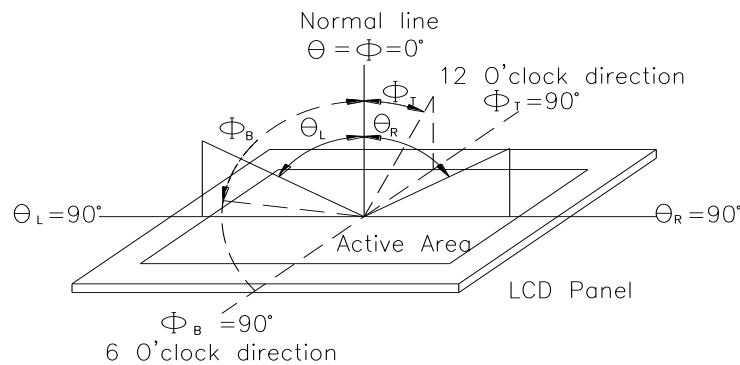

Fig. 8.1. Definition of viewing angle

Note 2: Test equipment setup:

After stabilizing and leaving the panel alone at a driven temperature for 10 minutes, the measurement should be executed. Measurement should be executed in a stable, windless, and dark room. Optical specifications are measured by Topcon BM-7orBM-5 luminance meter 1.0° field of view at a distance of 50cm and normal direction.

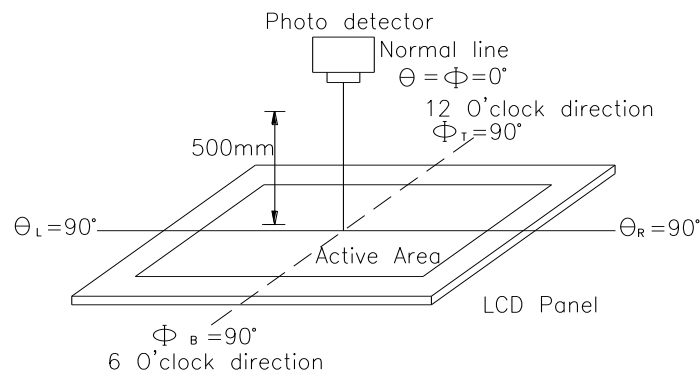
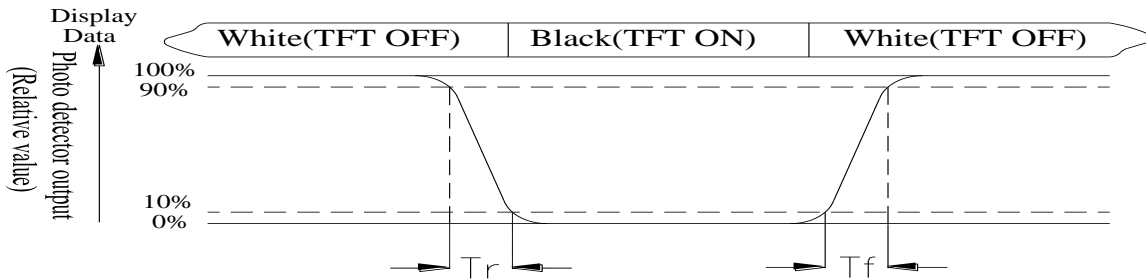

Fig. 8.2. Optical measurement system setup

Note 3: Definition of Response time:

The response time is defined as the LCD optical switching time interval between “White” state and “Black” state. Rise time, T_r , is the time between photo detector output intensity changed from 90% to 10%. And fall time, T_f , is the time between photo detector output intensity changed from 10% to 90%



Note 4: Definition of contrast ratio:

The contrast ratio is defined as the following expression.

$$\text{Contrast ratio (CR)} = \frac{\text{Luminance measured when LCD on the "White" state}}{\text{Luminance measured when LCD on the "Black" state}}$$

Note 5: Definition of Luminance Uniformity

Active area is divided into 9 measuring areas (reference the picture in below). Every measuring point is placed at the center of each measuring area.

$$\text{Luminance Uniformity (U)} = L_{\min}/L_{\max} \times 100\%$$

L = Active area length

W = Active area width

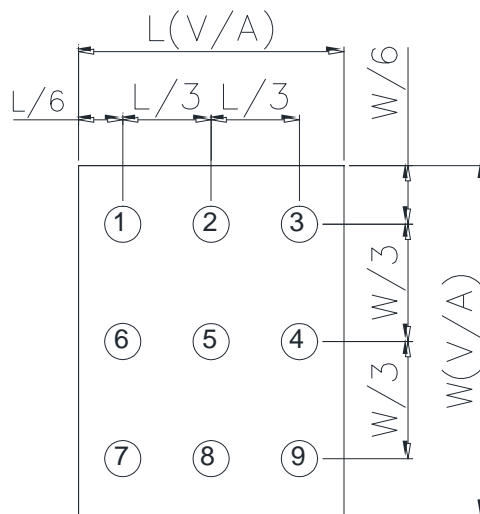

Fig8.3. Definition of uniformity

Note 6: Definition of color chromaticity (CIE 1931)

Color coordinates measured at the center point of LCD

Note 7: Measured at the center area of the panel when all the input terminals of LCD panel are electrically opened.

9.Interface

9.1. LCM PIN Definition

Pin	Symbol	Function	Remark
1	LED-	Power for LED backlight cathode	
2	LED+	Power for LED backlight anode	
3	GND	Power ground	
4	VCC	Power voltage	
5	R0	Red data (LSB)	
6	R1	Red data	
7	R2	Red data	
8	R3	Red data	
9	R4	Red data	
10	R5	Red data	
11	R6	Red data	
12	R7	Red data (MSB)	
13	G0	Green data (LSB)	
14	G1	Green data	
15	G2	Green data	
16	G3	Green data	
17	G4	Green data	
18	G5	Green data	
19	G6	Green data	
20	G7	Green data (MSB)	
21	B0	Blue data (LSB)	
22	B1	Blue data	
23	B2	Blue data	
24	B3	Blue data	
25	B4	Blue data	
26	B5	Blue data	
27	B6	Blue data	
28	B7	Blue data (MSB)	
29	GND	Power ground	
30	CLK	Pixel clock	
31	DISP	Display on/off	

32	NC	No connection	
33	NC	No connection	
34	DE	Data Enable	
35	NC	No connection	
36	GND	Power ground	
37	NC	No connection	
38	NC	No connection	
39	NC	No connection	
40	NC	No connection	

10. Block Diagram

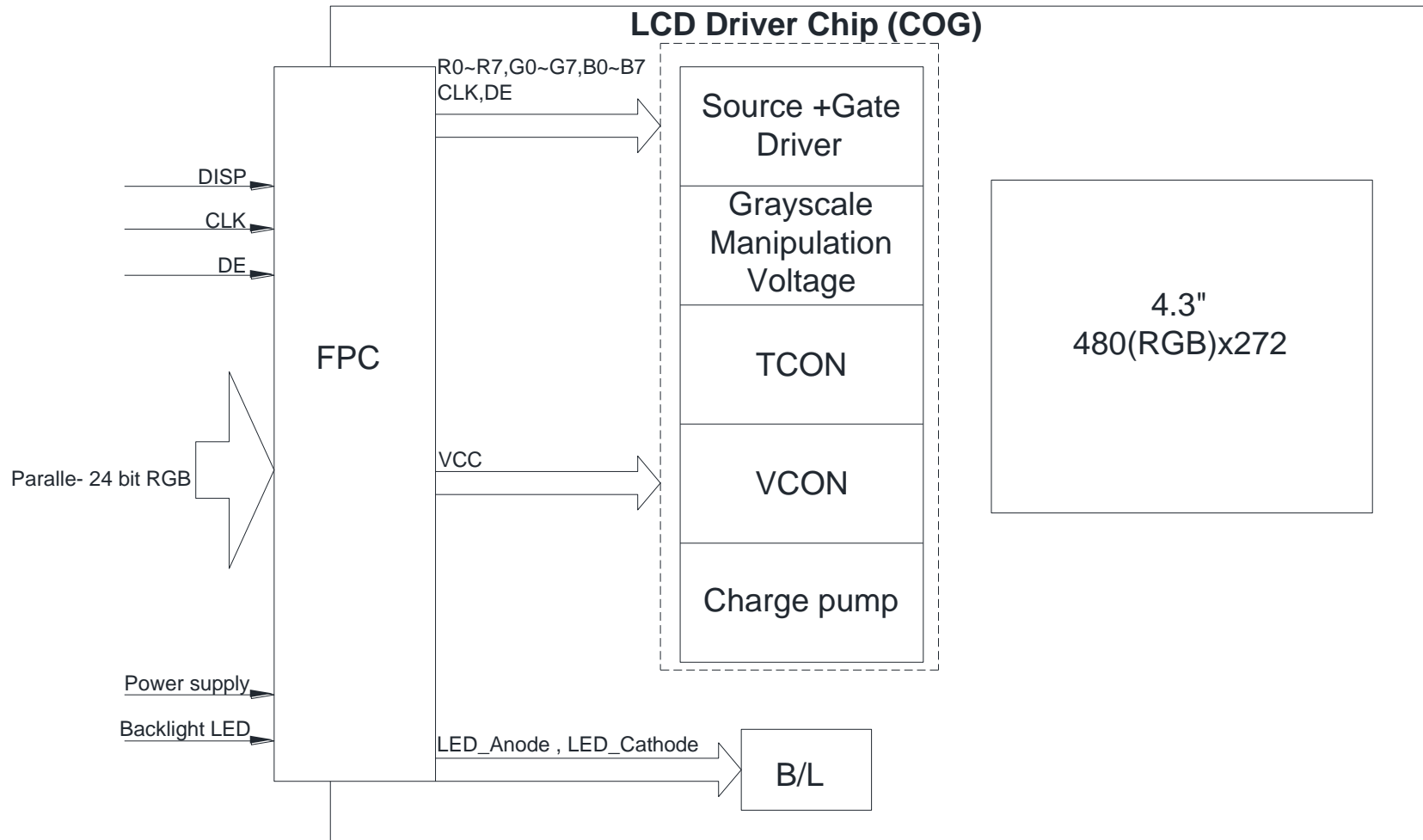

11. Reliability

Content of Reliability Test (Wide temperature, -20°C ~70°C)

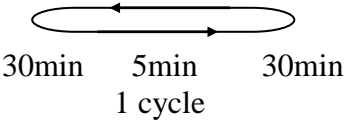
Environmental Test			
Test Item	Content of Test	Test Condition	Note
High Temperature storage	Endurance test applying the high storage temperature for a long time.	80°C 96hrs	2
Low Temperature storage	Endurance test applying the low storage temperature for a long time.	-30°C 96hrs	1,2
High Temperature Operation	Endurance test applying the electric stress (Voltage & Current) and the thermal stress to the element for a long time.	70°C 96hrs	—
Low Temperature Operation	Endurance test applying the electric stress under low temperature for a long time.	-20°C 96hrs	1
High Temperature/ Humidity Operation	The module should be allowed to stand at 60 °C, 90%RH max	60°C, 90%RH 96hrs	1,2
Thermal shock resistance	<p>The sample should be allowed stand the following 10 cycles of operation</p> <p style="text-align: center;">-20°C 25°C 70°C</p>  <p style="text-align: center;">30min 5min 30min 1 cycle</p>	-20°C /70°C 10 cycles	—
Vibration test	Endurance test applying the vibration during transportation and using.	Total fixed amplitude : 1.5mm Vibration Frequency : 10~55Hz One cycle 60 seconds to 3 directions of X,Y,Z for Each 15 minutes	3
Static electricity test	Endurance test applying the electric stress to the terminal.	VS=±600V(contact), ±800v(air), RS=330Ω CS=150pF 10 times	—

Note1: No dew condensation to be observed.

Note2: The function test shall be conducted after 4 hours storage at the normal Temperature and humidity after remove from the test chamber.

Note3: The packing have to including into the vibration testing.

12. Contour Drawing

PIN NO.	SYMBOL
1	LED-
2	LED+
3	GND
4	VCC
5	R0
6	R1
7	R2
8	R3
9	R4
10	R5
11	R6
12	R7
13	G0
14	G1
15	G2
16	G3
17	G4
18	G5
19	G6
20	G7
21	B0
22	B1
23	B2
24	B3
25	B4
26	B5
27	B6
28	B7
29	GND
30	CLK
31	DISP
32	NC
33	NC
34	DE
35	NC
36	GND
37	NC
38	NC
39	NC
40	NC

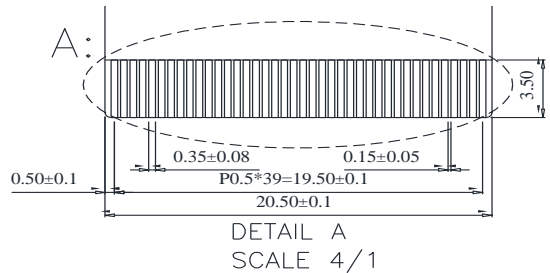
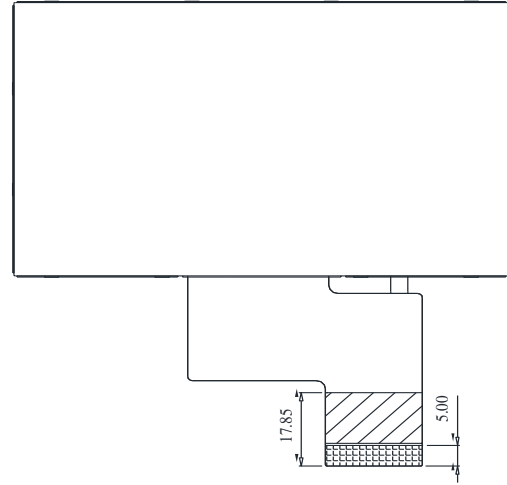
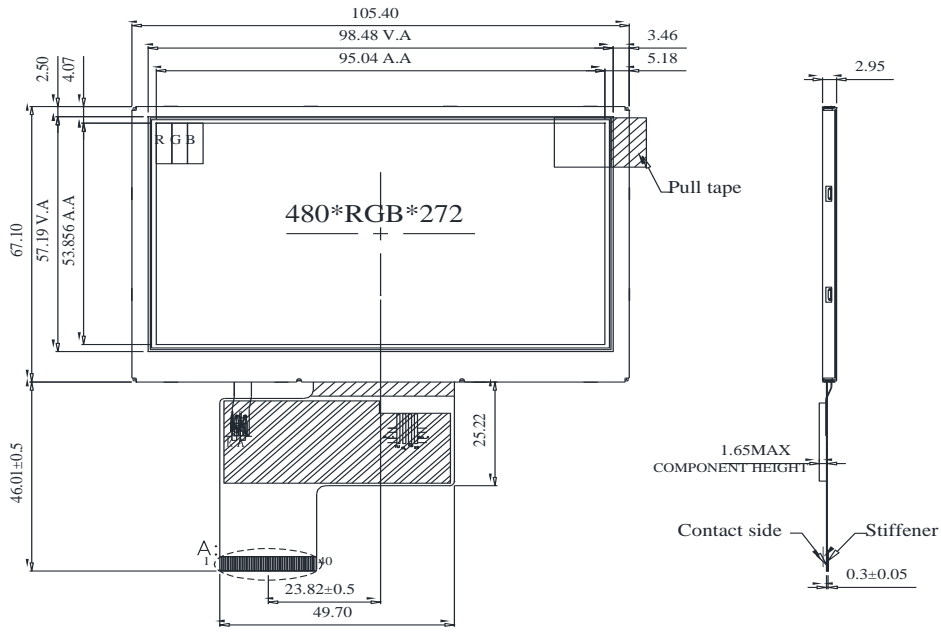

The non-specified tolerance of dimension is ± 0.3 mm .



1、Panel Specification :

- 1. Panel Type : Pass NG , _____
- 2. View Direction : Pass NG , _____
- 3. Numbers of Dots : Pass NG , _____
- 4. View Area : Pass NG , _____
- 5. Active Area : Pass NG , _____
- 6. Operating Temperature : Pass NG , _____
- 7. Storage Temperature : Pass NG , _____
- 8. Others : _____

2、Mechanical Specification :

- 1. PCB Size : Pass NG , _____
- 2. Frame Size : Pass NG , _____
- 3. Material of Frame : Pass NG , _____
- 4. Connector Position : Pass NG , _____
- 5. Fix Hole Position : Pass NG , _____
- 6. Backlight Position : Pass NG , _____
- 7. Thickness of PCB : Pass NG , _____
- 8. Height of Frame to PCB : Pass NG , _____
- 9. Height of Module : Pass NG , _____
- 10. Others : Pass NG , _____

3、Relative Hole Size :

- 1. Pitch of Connector : Pass NG , _____
- 2. Hole size of Connector : Pass NG , _____
- 3. Mounting Hole size : Pass NG , _____
- 4. Mounting Hole Type : Pass NG , _____
- 5. Others : Pass NG , _____

4、Backlight Specification :

- 1. B/L Type : Pass NG , _____
- 2. B/L Color : Pass NG , _____
- 3. B/L Driving Voltage (Reference for LED Type) : Pass NG , _____
- 4. B/L Driving Current : Pass NG , _____
- 5. Brightness of B/L : Pass NG , _____
- 6. B/L Solder Method : Pass NG , _____
- 7. Others : Pass NG , _____

>> **Go to page 2** <<



Winstar Module Number : _____

Page: 2

5、Electronic Characteristics of Module :

- 1. Input Voltage : Pass NG , _____
- 2. Supply Current : Pass NG , _____
- 3. Driving Voltage for LCD : Pass NG , _____
- 4. Contrast for LCD : Pass NG , _____
- 5. B/L Driving Method : Pass NG , _____
- 6. Negative Voltage Output : Pass NG , _____
- 7. Interface Function : Pass NG , _____
- 8. LCD Uniformity : Pass NG , _____
- 9. ESD test : Pass NG , _____
- 10. Others : Pass NG , _____

6、Summary :

Sales signature : _____

Customer Signature : _____

Date : / / _____