



**WINSTAR Display Co.,Ltd.**  
**華凌光電股份有限公司**



**Winstar Display Co., LTD**

**華凌光電股份有限公司**

WEB: <https://www.winstar.com.tw> E-mail: sales@winstar.com.tw



## SPECIFICATION

**CUSTOMER :** \_\_\_\_\_

**MODULE NO.:** WF43UTIAEDNGA#

<p><b>APPROVED BY:</b></p> <p>( FOR CUSTOMER USE ONLY )</p>	<p><b>PCB VERSION:</b> _____</p> <p><b>DATA:</b> _____</p>
---	--

SALES BY	APPROVED BY	CHECKED BY	PREPARED BY
			葉虹蘭
<b>ISSUED DATE: 2018/11/22</b>			

This TFT Display item is for Economical Version TFT LCM Inspection Specification:

<https://www.winstar.com.tw/technology/download.html>

RECORDS OF REVISION			DOC. FIRST ISSUE
VERSION	DATE	REVISED PAGE NO.	SUMMARY
0	2018/08/07		First issue
A	2018/11/22		Add TFT Driver IC Upgrade AC CHARATERISTICS & DC CHARATERISTICS

# Contents

1.Module Classification Information

2.Summary

3.General Specification

4.Absolute Maximum Ratings

5.Electrical Characteristics

6.DC Characteristics

7.AC Characteristics

8.Optical Characteristics

9.Interface

10.Block Diagram

11.Reliability

12.Touch Panel Information

13.Contour Drawing

14.Other

# 1.Module Classification Information

W F 43 U T I A E D N G A #  
 ① ② ③ ④ ⑤ ⑥ ⑦ ⑧ ⑨ ⑩ ⑪ ⑫ ⑬

①	Brand : WINSTAR DISPLAY CORPORATION											
②	Display Type : F→TFT Type, J→Custom TFT											
③	Display Size : 4.3" TFT											
④	Model serials no.											
⑤	Backlight Type :		F→CCFL, White S→LED, High Light White				T→LED, White Z→Nichia LED, White					
⑥	LCD Polarize Type/ Temperature range/ Gray Scale Inversion Direction		A→Transmissive, N.T, IPS TFT C→Transmissive, N. T, 6:00 ; F→Transmissive, N.T,12:00 ; I→Transmissive, W. T, 6:00 K→Transflective, W.T,12:00 L→Transmissive, W.T,12:00 N→Transmissive, Super W.T, 6:00				Q→Transmissive, Super W.T, 12:00 R→Transmissive, Super W.T, O-TFT V→Transmissive, Super W.T, VA TFT W→Transmissive, Super W.T, IPS TFT X→Transmissive, W.T, VA TFT Y→Transmissive, W.T, IPS TFT Z→Transmissive, W.T, O-TFT					
⑦	A : TFT LCD B : TFT+SCREW HOLES+CONTROL BOARD C : TFT+ SCREW HOLES +A/D BOARD D : TFT+ SCREW HOLES +A/D BOARD+CONTROL BOARD E : TFT+ SCREW HOLES +POWER BOARD					F : TFT+CONTROL BOARD G : TFT+ SCREW HOLES H : TFT+D/V BOARD I : TFT+ SCREW HOLES +D/V BOARD J : TFT+POWER BD						
⑧	Resolution:											
	A	128160	B	320234	C	320240	D	480234	E	480272	F	640480
	G	800480	H	1024600	I	320480	J	240320	K	800600	L	240400
	M	1024768	N	128128	P	1280800	Q	480800	R	640320	S	480128
	T	800320	U	8001280	V	176220	W	1280398	X	1024250	Y	1920720
	Z	800200	2	1024324	3	7201280	4	19201200	5	1366768	6	1280320
⑨	D: Digital L : LVDS M:MIPI											
⑩	Interface:											
	N	Without control board			A	8Bit		B	16Bit		H	HDMI
	I	I2C Interface			R	RS232		S	SPI Interface		U	USB
⑪	TS:											
	N	Without TS			T	Resistive touch panel			C	Capacitive touch panel (G-F-F)		
	G	Capacitive touch panel (G-G)					C1	Capacitive touch panel (G-F-F)+OCA				
	C2	Capacitive touch panel (G-F-F)+OCR					G1	Capacitive touch panel (G-G)+OCA				
	G2	Capacitive touch panel (G-G)+OCR					B	CTP+GG+USB				
⑫	Version: X:Raspberry pi											
⑬	Special Code		#:Fit in with ROHS directive regulations									

## **2.Summary**

TFT 4.3” is a TN transmissive type color active matrix TFT liquid crystal display that use amorphous silicon TFT as switching devices. This module is a composed of a TFT\_LCD module, It is usually designed for indusrial application and this module follows RoHs,

### 3. General Specifications

Item	Dimension	Unit
Size	4.3	inch
Dot Matrix	480 x RGBx272(TFT)	dots
Module dimension	105.5(W) x 67.2(H) x 4.6(D)	mm
Active area	95.04 x 53.856	mm
Dot pitch	0.066 x 0.198	mm
LCD type	TFT, Normally White, Transmissive	
View Direction	12 o'clock	
Gray Scale Inversion Direction	6 o'clock	
Aspect Ratio	16:9	
TFT Driver IC	ST7282-G4-1L	
TFT Interface	24-bit RGB	
Backlight Type	LED, Normally White	
CTP FW Version	3	
CTP IC	FT5426DQ8	
CTP Interface	I2C	
With /Without TP	With CTP	
Surface	Glare	

\*Color tone slight changed by temperature and driving voltage.

## 4. Absolute Maximum Ratings

Item	Symbol	Min	Typ	Max	Unit
Operating Temperature	TOP	-20	—	+70	°C
Storage Temperature	TST	-30	—	+80	°C

Note: Device is subject to be damaged permanently if stresses beyond those absolute maximum ratings listed above

1. Temp.  $\leq 60^{\circ}\text{C}$ , 90% RH MAX. Temp.  $> 60^{\circ}\text{C}$ , Absolute humidity shall be less than 90% RH at  $60^{\circ}\text{C}$

# 5. Electrical Characteristics

## 5.1. Operating conditions:

Item	Symbol	Condition	Min	Typ	Max	Unit
Supply Voltage For Logic	VCC	—	3.1	3.3	3.5	V
Digital operation current	Icc	—		22	33	mA
Supply Voltage For CTP	VDDT	--	2.8	3.1	3.3	V

## 5.2. LED driving conditions

Item	Symbol	Min	Typ	Max	Unit	Remark
LED current	—	—	20	—	mA	
Power Consumption	—	—	640	680	mW	
LED voltage	LED+	29	32	35	V	Note 1
LED Life Time	—	—	50,000	—	Hr	Note 2,3,4

Note 1 : There are 1 Groups LED

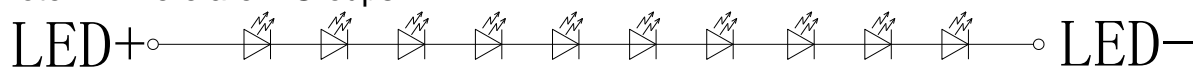

Note 2 : Ta = 25 °C

Note 3 : Brightness to be decreased to 50% of the initial value

Note 4 : The single LED lamp case

## 6.DC CHARATERISTICS

Parameter	Symbol	Rating			Unit	Condition
		Min	Typ	Max		
Low level input voltage	$V_{IL}$	0	-	0.3VCC	V	
High level input voltage	$V_{IH}$	0.7VCC	-	VCC	V	

# 7.AC CHARACTERISTICS

## 7.1. AC Characteristics

AC Electrical Characteristics (VCC= 3.3V, GND= 0V, TA=25°C)

Item	Symbol	Min.	Typ.	Max.	Unit	Conditions
System operation timing						
VCC power source slew time	TPOR	-	-	20	Ms	From 0V to 99% VCC
GRB pulse width	tRSTW	10	50	-	us	R=10Kohm, C=1uF
Input/ Output timing						
CLK pulse duty	Tcw	40	50	60	%	
Hsync width	Thw	2	-	-	DCLK	
Hsync period	Th	55	60	65	us	
Vsync setup time	Tvst	12	-	-	ns	
Vsync hold time	Tvhd	12	-	-	ns	
Hsync setup time	Thst	12	-	-	ns	
Hsync hold time	Thhd	12	-	-	ns	
Data setup time	Tdsu	12	-	-	ns	
Data hold time	Tdhd	12	-	-	ns	
DE setup time	Tdest	10	-	-	ns	
DE setup time	Tdehd	10	-	-	ns	

## 7.2. AC Timing Diagram

### Clock and Data Input Timing Diagram

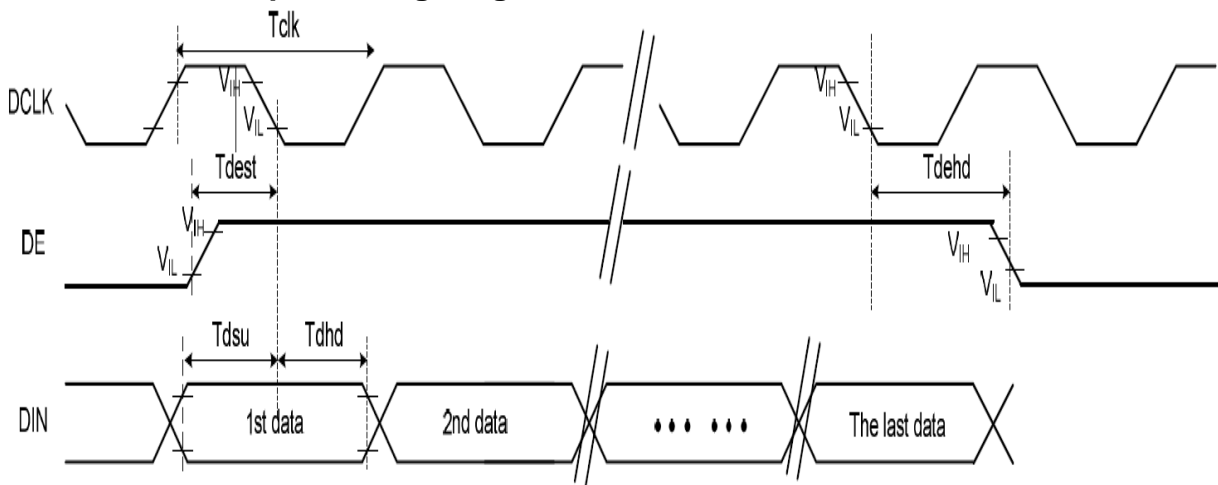

### 7.3. Parallel DE mode 24-bit RGB Timing Table

Item	Symbol	Min	Typ	Max	Unit	Remark	
CLK frequency	Fclk	8	9	12	MHz		
DCLK Period	Tclk	83	111	125	ns		
HSYNC	Period Time	Th	485	531	598	DCLK	
	Display Period	Thdisp		480		DCLK	
	Back Porch	Thbp	3	43	43	DCLK	By H_Blanking setting
	Front Porch	Thfp	2	8	75	DCLK	
	Pulse Width	Thw	2	4	75	DCLK	
VSYNC	Period Time	Tv	276	292	321	H	
	Display Period	Tvdisp		272		H	
	Back Porch	Tvbp	2	12	12	H	By V_Blanking setting
	Front Porch	Tvfp	2	8	37	H	
	Pulse Width	Tvw	2	4	37	H	

### 7.4. DE Mode Timing Diagram

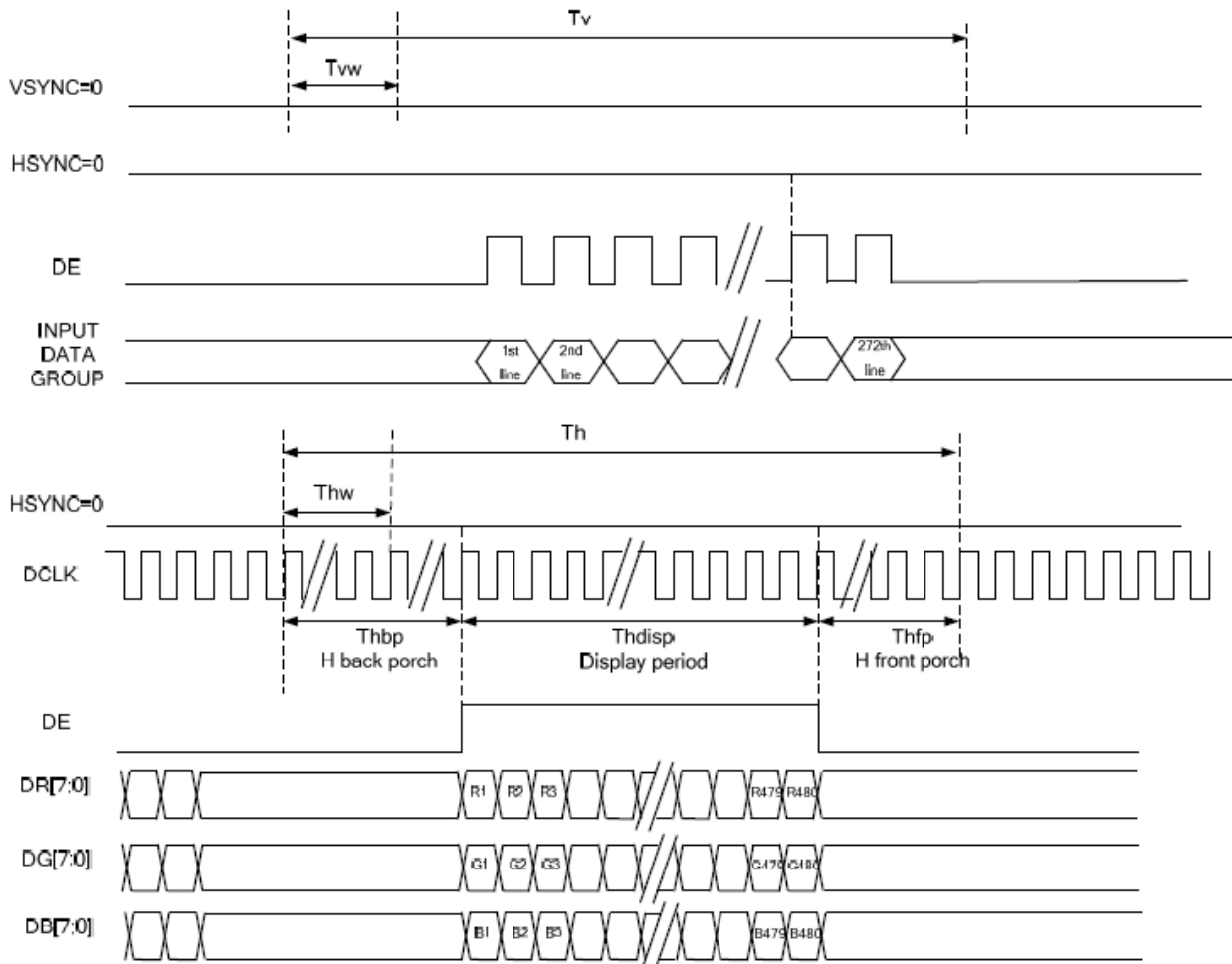

# 8. Optical Characteristics

Item	Symbol	Condition.	Min	Typ.	Max.	Unit	Remark	
Response time	Tr	$\theta=0^\circ$ 、 $\phi=0^\circ$	-	25	30	ms	Note 3	
	Tf							
Contrast ratio	CR	At optimized viewing angle	300	500	-	-	Note 4	
Color Chromaticity	White	Wx	$\theta=0^\circ$ 、 $\phi=0$	0.26	0.31	0.36	-	Note 2,6,7
		Wy		0.28	0.33	0.38	-	
Viewing angle (Gray Scale Inversion Direction)	Hor.	$\Theta_R$	$CR \geq 10$	-	70	-	Deg.	Note 1
		$\Theta_L$		-	70	-		
	Ver.	$\Phi_T$		-	50	-		
		$\Phi_B$		-	60	-		
Brightness	-	-	300	400	-	cd/m <sup>2</sup>	Center of display	
Uniformity	(U)	-	75	-	-	%	Note5	

Ta=25±2°C

Note 1: Definition of viewing angle range

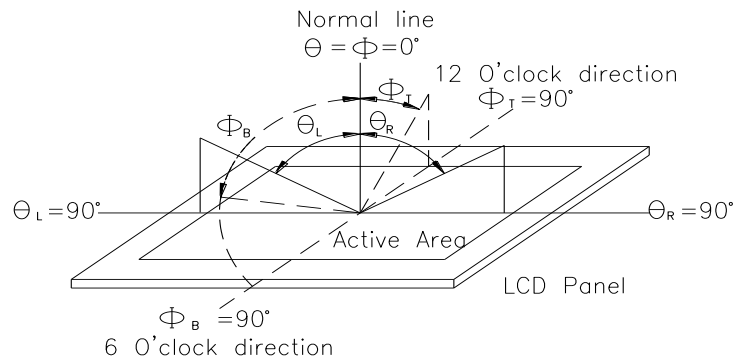

Fig. 8.1. Definition of viewing angle

Note 2: Test equipment setup:

After stabilizing and leaving the panel alone at a driven temperature for 10 minutes, the measurement should be executed. Measurement should be executed in a stable, windless, and dark room. Optical specifications are measured by Topcon BM-7orBM-5 luminance meter 1.0° field of view at a distance of 50cm and normal direction.

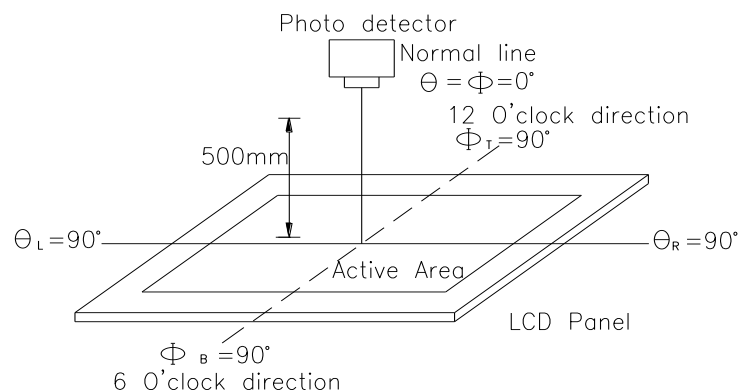
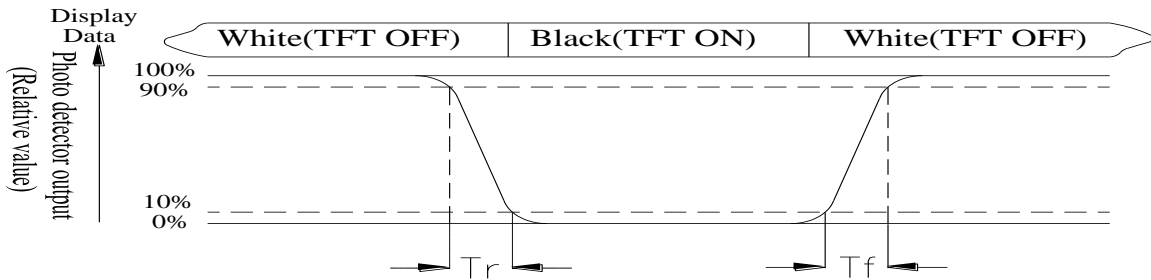

Fig. 8.2. Optical measurement system setup

**Note 3: Definition of Response time:**

The response time is defined as the LCD optical switching time interval between “White” state and “Black” state. Rise time,  $T_r$ , is the time between photo detector output intensity changed from 90% to 10%. And fall time,  $T_f$ , is the time between photo detector output intensity changed from 10% to 90%



**Note 4: Definition of contrast ratio:**

The contrast ratio is defined as the following expression.

$$\text{Contrast ratio (CR)} = \frac{\text{Luminance measured when LCD on the "White" state}}{\text{Luminance measured when LCD on the "Black" state}}$$

**Note 5: Definition of Luminance Uniformity**

Active area is divided into 9 measuring areas (reference the picture in below). Every measuring point is placed at the center of each measuring area.

$$\text{Luminance Uniformity (U)} = \text{Lmin/Lmax} \times 100\%$$

L = Active area length

W = Active area width

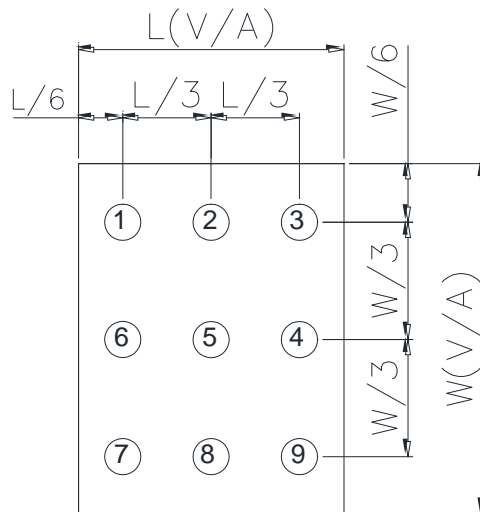

Fig.8.3. Definition of uniformity

**Note 6: Definition of color chromaticity (CIE 1931)**

Color coordinates measured at the center point of LCD

Note 7: Measured at the center area of the panel when all the input terminals of LCD panel are electrically opened.

# 9. Interface

## 9.1. LCM PIN Definition

Pin	Symbol	Function	Remark
1	LED-	Power for LED backlight cathode	
2	LED+	Power for LED backlight anode	
3	GND	Power ground	
4	VCC	Power voltage	
5	R0	Red data (LSB)	
6	R1	Red data	
7	R2	Red data	
8	R3	Red data	
9	R4	Red data	
10	R5	Red data	
11	R6	Red data	
12	R7	Red data (MSB)	
13	G0	Green data (LSB)	
14	G1	Green data	
15	G2	Green data	
16	G3	Green data	
17	G4	Green data	
18	G5	Green data	
19	G6	Green data	
20	G7	Green data (MSB)	
21	B0	Blue data (LSB)	
22	B1	Blue data	
23	B2	Blue data	
24	B3	Blue data	
25	B4	Blue data	
26	B5	Blue data	
27	B6	Blue data	
28	B7	Blue data (MSB)	
29	GND	Power ground	
30	CLK	Pixel clock	

31	DISP	Display on/off	
32-33	NC	No connection	
34	DE	Data Enable	
35	NC	No connection	
36	GND	Power ground	
37-40	NC	No connection	

## 9.2. CTP PIN Definition

Pin	Symbol	Function	Remark
1	VSS	Ground for analog circuit	
2	VDDT	Power Supply : +3.0V	
3	SCL	I2C clock input	
4	NC	No connect	
5	SDA	I2C data input and output	
6	NC	No connect	
7	/RST	External Reset, Low is active	
8	NC	No connect	
9	/INT	External interrupt to the host	
10	VSS	Ground for analog circuit	

# 10. Block Diagram

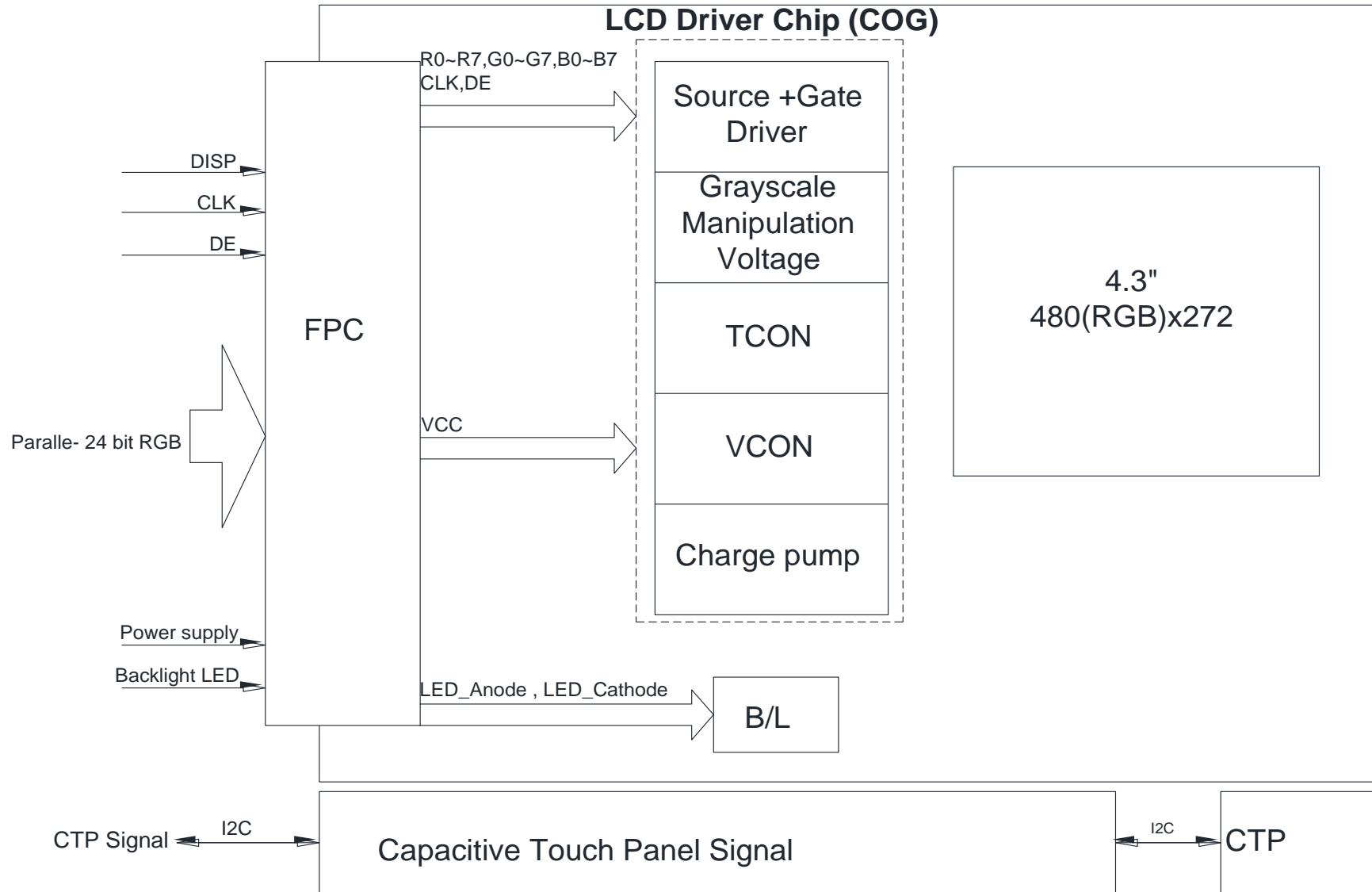

# 11. Reliability

Content of Reliability Test (Wide temperature, -20°C ~70°C)

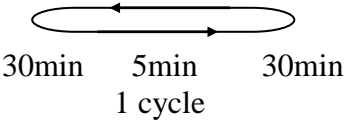
Environmental Test			
Test Item	Content of Test	Test Condition	Note
High Temperature storage	Endurance test applying the high storage temperature for a long time.	80°C 96hrs	2
Low Temperature storage	Endurance test applying the low storage temperature for a long time.	-30°C 96hrs	1,2
High Temperature Operation	Endurance test applying the electric stress (Voltage & Current) and the thermal stress to the element for a long time.	70°C 96hrs	—
Low Temperature Operation	Endurance test applying the electric stress under low temperature for a long time.	-20°C 96hrs	1
High Temperature/ Humidity Operation	The module should be allowed to stand at 60 °C, 90%RH max	60°C, 90%RH 96hrs	1,2
Thermal shock resistance	<p>The sample should be allowed stand the following 10 cycles of operation</p> <p style="text-align: center;">-20°C    25°C    70°C</p>  <p style="text-align: center;">30min    5min    30min 1 cycle</p>	-20°C /70°C 10 cycles	—
Vibration test	Endurance test applying the vibration during transportation and using.	Total fixed amplitude : 1.5mm Vibration Frequency : 10~55Hz One cycle 60 seconds to 3 directions of X,Y,Z for Each 15 minutes	3
Static electricity test	Endurance test applying the electric stress to the terminal.	VS=±600V(contact), ±800v(air), RS=330Ω CS=150pF 10 times	—

Note1: No dew condensation to be observed.

Note2: The function test shall be conducted after 4 hours storage at the normal Temperature and humidity after remove from the test chamber.

Note3: The packing have to including into the vibration testing.

# 12.Touch Panel Information

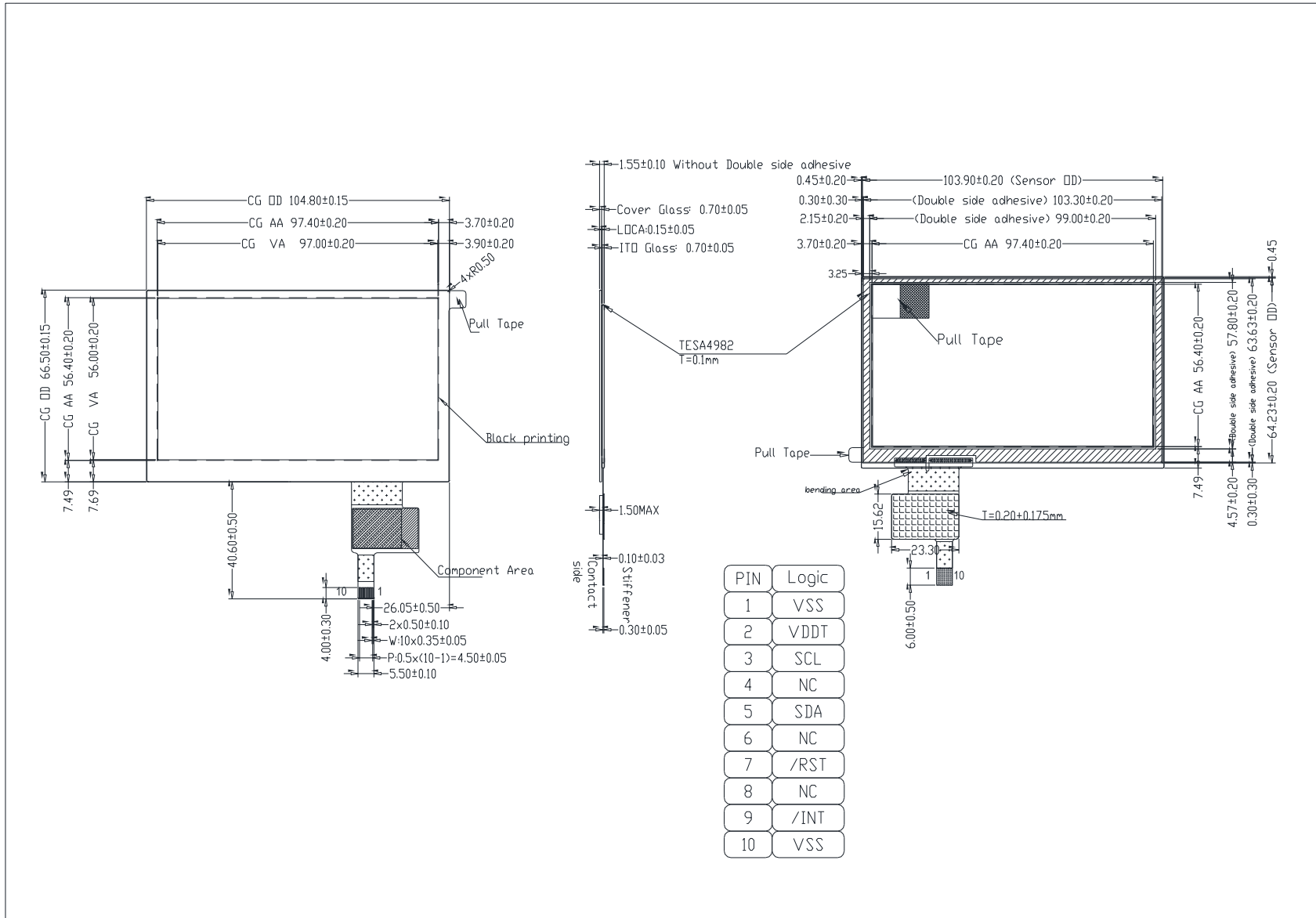

PIN	Logic
1	VSS
2	VDDT
3	SCL
4	NC
5	SDA
6	NC
7	/RST
8	NC
9	/INT
10	VSS





**1、Panel Specification :**

- 1. Panel Type :  Pass  NG , \_\_\_\_\_
- 2. View Direction :  Pass  NG , \_\_\_\_\_
- 3. Numbers of Dots :  Pass  NG , \_\_\_\_\_
- 4. View Area :  Pass  NG , \_\_\_\_\_
- 5. Active Area :  Pass  NG , \_\_\_\_\_
- 6. Operating Temperature :  Pass  NG , \_\_\_\_\_
- 7. Storage Temperature :  Pass  NG , \_\_\_\_\_
- 8. Others : \_\_\_\_\_

**2、Mechanical Specification :**

- 1. PCB Size :  Pass  NG , \_\_\_\_\_
- 2. Frame Size :  Pass  NG , \_\_\_\_\_
- 3. Material of Frame :  Pass  NG , \_\_\_\_\_
- 4. Connector Position :  Pass  NG , \_\_\_\_\_
- 5. Fix Hole Position :  Pass  NG , \_\_\_\_\_
- 6. Backlight Position :  Pass  NG , \_\_\_\_\_
- 7. Thickness of PCB :  Pass  NG , \_\_\_\_\_
- 8. Height of Frame to PCB :  Pass  NG , \_\_\_\_\_
- 9. Height of Module :  Pass  NG , \_\_\_\_\_
- 10. Others :  Pass  NG , \_\_\_\_\_

**3、Relative Hole Size :**

- 1. Pitch of Connector :  Pass  NG , \_\_\_\_\_
- 2. Hole size of Connector :  Pass  NG , \_\_\_\_\_
- 3. Mounting Hole size :  Pass  NG , \_\_\_\_\_
- 4. Mounting Hole Type :  Pass  NG , \_\_\_\_\_
- 5. Others :  Pass  NG , \_\_\_\_\_

**4、Backlight Specification :**

- 1. B/L Type :  Pass  NG , \_\_\_\_\_
- 2. B/L Color :  Pass  NG , \_\_\_\_\_
- 3. B/L Driving Voltage (Reference for LED Type) :  Pass  NG , \_\_\_\_\_
- 4. B/L Driving Current :  Pass  NG , \_\_\_\_\_
- 5. Brightness of B/L :  Pass  NG , \_\_\_\_\_
- 6. B/L Solder Method :  Pass  NG , \_\_\_\_\_
- 7. Others :  Pass  NG , \_\_\_\_\_

>> **Go to page 2** <<



Winstar      Module Number : \_\_\_\_\_

Page: 2

**5、Electronic Characteristics of Module :**

- 1. Input Voltage :                       Pass                       NG , \_\_\_\_\_
- 2. Supply Current :                       Pass                       NG , \_\_\_\_\_
- 3. Driving Voltage for LCD :            Pass                       NG , \_\_\_\_\_
- 4. Contrast for LCD :                     Pass                       NG , \_\_\_\_\_
- 5. B/L Driving Method :                 Pass                       NG , \_\_\_\_\_
- 6. Negative Voltage Output :          Pass                       NG , \_\_\_\_\_
- 7. Interface Function :                  Pass                       NG , \_\_\_\_\_
- 8. LCD Uniformity :                      Pass                       NG , \_\_\_\_\_
- 9. ESD test :                               Pass                       NG , \_\_\_\_\_
- 10. Others :                                 Pass                       NG , \_\_\_\_\_

**6、Summary :**

Sales signature : \_\_\_\_\_

Customer Signature : \_\_\_\_\_

Date :        /        /        \_\_\_\_\_