

**ARKLED** 无锡市方舟科技电子有限公司

WUXI ARK TECHNOLOGY ELECTRONIC CO., LTD

# 规格(承认)书

Specification for approval

※ 方舟 P/N (ARKLED P/N) : SR720562W

※ 客户 P/N (CUSTOMER P/N) : \_\_\_\_\_

※ 产品说明 (DESCRIPTION) :

1、

2、

3、

※ 日期 (DATE) : 2019年10月06日

地址: 江苏省宜兴市张渚镇金张渚工业区宇龙路 6 号

ADD: NO.6 Yulong Road, ZHANGZHU TOWN, YIXING CITY, JIANGSU PROVINCE,  
P.R.CHINA

电话 (TEL) : 0086-510-87341161 87345700

传真(FAX) : 0086-510-87342800

E-mail: [zhuzp@arkch.com](mailto:zhuzp@arkch.com)

网址(http) : [www.arkch.com](http://www.arkch.com)

型号 Type :

SR720562W



■ 产品特征 FEATURES:

- 高可靠性和高稳定性

**High intensity and reliability**

- 高品质、和低功耗、低成本

**High quality, Low power requirement and low cost**

- IC 易兼容、易装配

**IC compatible , Easy assembly**

- 符合 RoHS 指令要求

**Meet RoHS EU Directive**

- 静电承受能力(HMB)1000V

**ESD(HMB) 1000V**

■ 产品描述 DESCRIPTION:

- 0.56 英寸四位数码管

**0.56 Inch four Digits Display**

- 极性共阴

**Common Cathode**

- 黑面, 黄胶

**Black face, yellow segment**

- 发光颜色

**Luminous Color:**

1、白色 WHITE (蓝转白 blue to white)

2、

- 晶片材质

**Chips Materials**

1、InGaN

2、

- 特别备注

Special request

型号 Type :

SR720562W



■ 产品最大绝对参数值 (Ta: 25°C) ABSOLUTE MAXIMUM RATINGS AT Ta=25°C:

PARAMETER 项目	SYMBOL 符号	WHITE 白色	UNIT 单位
Power Dissipation Per Segment 功耗	PAD	70	mw
Reverse Voltage Per Segment 反向耐压	VR	5	V
Continuous Forward Current Per Segment 最大使用电流	IAF	20	mA
Peak Forward Current Per Segment(Duty-0.1,1KHz) 最大峰值电流	IPF	60	mA
Operating Temperature Range 工作温度	TOPr	-20°C to 80°C	
Storage Temperature Range 贮藏温度	Tstg	-30°C to 85°C	
Lead Soldering Temperature 260°C at 1.6mm From Body for 3 second 焊接温度 260°C/3 秒 距离胶体 1.6mm 以上			

■ 产品光电参数值 (Ta: 25°C) ELECTRICAL/OPTICAL CHARACTERISTICS AT Ta=25°C:

PARAMETER 项目	SYMBOL 符号	TEST CONDITION 测试条件	Color 颜色	MIN 最小值	TYP 标准值	MAX 最大值	UNIT 单位
Forward Voltage ,Per Segment 正向压降	VF	IF=20mA	白色 WHITE	2.8	3.0	3.5	V
Reverse Current , Per Segment 反向漏电流	IR	VR=5V	白色 WHITE			50	μA
Peak Emission Wavelength 峰值波长	λd	IF=20mA	白色 WHITE	X: 0.2681		X: 0.3256	
				Y: 0.2615		Y: 0.3475	
Luminous Intensity Per Segment 法向光强	IV	IF=20mA	白色 WHITE	50		80	mcd

型号 Type :  
SR720562W



RELATIVE INTENSITY VS. WAVELENGTH

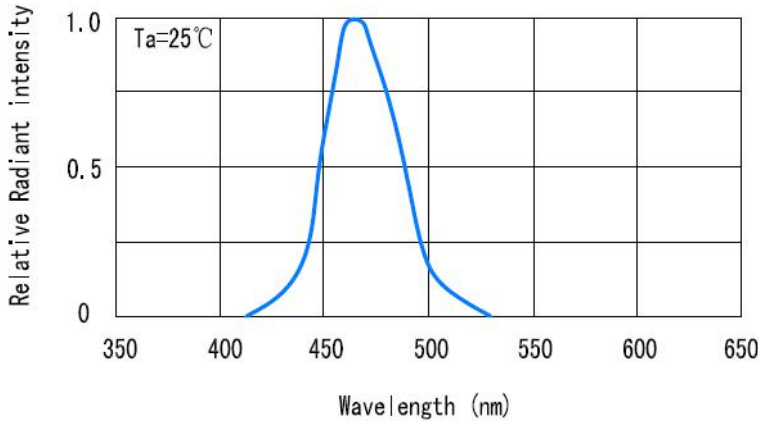

FORWARD CURRENT VS. FORWARD VOLTAGE

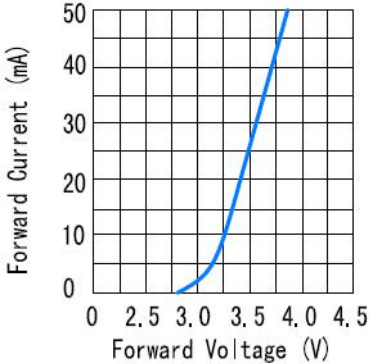

LUMINOUS INTENSITY VS. FORWARD CURRENT

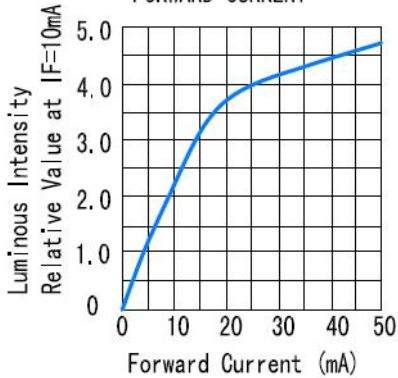

ALLOWABLE FORWARD CURRENT AMBIENT TEMPERATURE

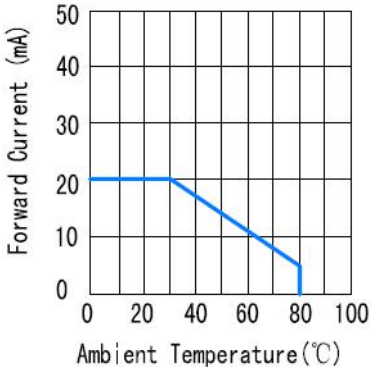

LUMINOUS INTENSITY VS. AMBIENT TEMPERATURE

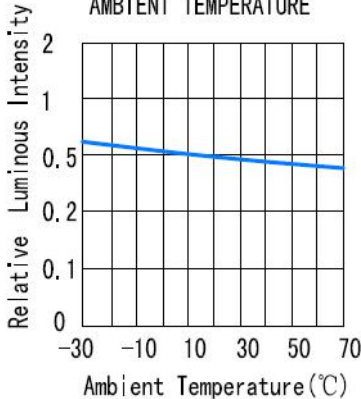

型号 Type :

SR720562W

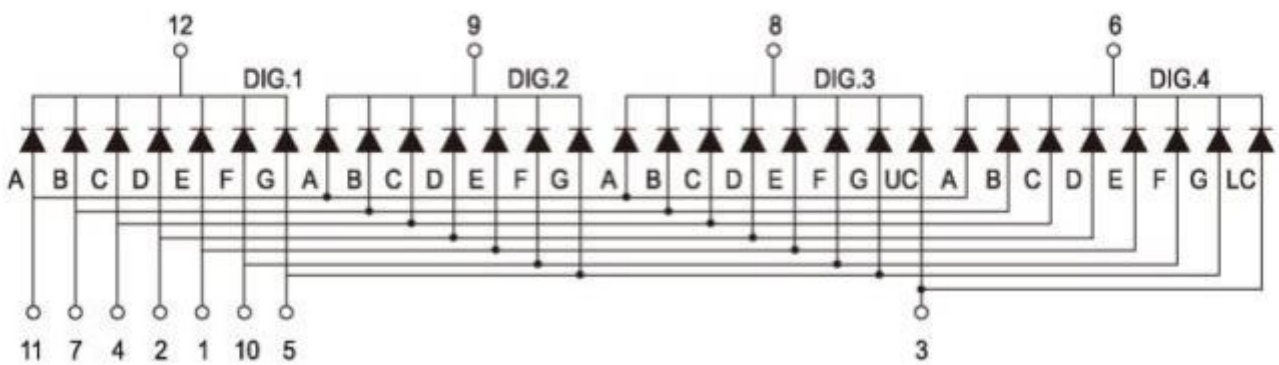
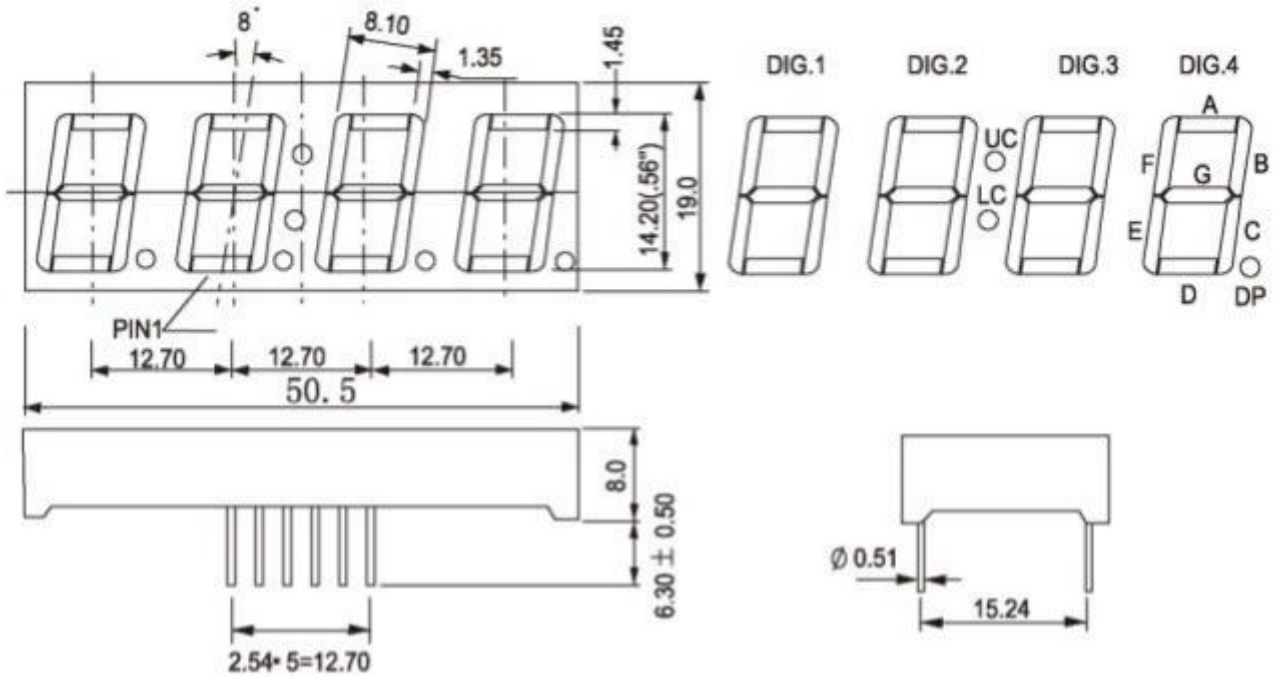

NOTES : 1. All dimensions are in millimeters. (inches)

2. Tolerance is  $\pm 0.25(0.010)$  unless otherwise specified.