

规格书

DATASHEET

◆ 方舟 P/N (ARKLED P/N): **D-Y080508Y1-KS2**

◆ 日期 (Date): **2015-06-27**

◆ 版本 (Version): **V1.0**

制定: _____

审核: _____

地址: 江苏省宜兴市金张渚工业集中区宇龙路 6 号

Add: NO.6, Yulong Road, Golden Zhangzhu Industrial Park, Yixing City, Jiangsu Province, China

电话(Tel): 销售(Sales): 0086-510-87341161

技术(Tech) : 0086-510-87341558

邮箱(Email): 销售(Sales): sales@arkchn.com

技术(Tech) : tech@arkchn.com

传真(Fax): 0086-510-87342800

网址(Website) : www.arkch.com



产品特征

- 由 8mm 料带装载在直径 7 英寸料盘上
- 适用于高速贴片设备
- 适用于回流焊接设备
- 高可靠性和高稳定性
- 高品质、和低功耗、低成本
- 符合 RoHS 指令要求
- 符合无铅要求
- 静电承受能力 2000V (HBM)

Fetures

- Package in 8mmtape on 7" diameter reel
- Compatible with automatic placement equipment.
- Compatible with infrared and vapor phase reflow solder process.
- High intensity and reliability.
- High quality, Low power requirement and low cost.
- The product itself will remain within RoHS compliant version.
- Pb-free.
- ESD 2000V(HBM).

物料基本信息

Device Selection Guide

芯片材料 Chip material	发光颜色 Emitted color	环氧树脂颜色 Resin Color
AlGaInP	黄色 Yellow	透明 Water Clear



绝对最大额定参数 Absolute Maximum Ratings(Ta=25℃)

参数 Parameter	符号 Symbol	最大 Maximum	单位 Unit
功率 Power Dissipation	Pd	50	mW
峰值正向电流 Peak Forward Current (Duty 1/10 @1KHz)	IF(Peak)	60	mA
正向电流 Continuous Forward Current	IF	20	mA
反向电压 Reverse Voltage	VR	5	V
静电放电 Electrostatic Discharge(HBM)	ESD	2000	V
工作温度范围 Operating Temperature Range	Topr	-30 to +80	℃
存储温度范围 Storage Temperature Range	Tstg	-40 to +90	℃
焊接温度 Soldering Temperature	Tsol	回流焊：260℃/10 sec 手工焊：350℃/3 sec Reflow Soldering : 260 ℃ for 10 sec. Hand Soldering : 350 ℃ for 3 sec.	



光电参数 Electrical/Optical Characteristics(Ta=25℃)

参数 Parameter	符号 Symbol	最小值 Min.	平均值 Typ.	最大值 Max.	单位 Unit	条件 Condition
发光强度 Luminous Intensity	IV	26		37	mcd	IF=5mA
主波长 Dominant Wavelength	λ_d	586		592	nm	IF=5mA
视角 Viewing angle	2 θ 1/2	-----	120	-----	Deg	IF=5mA
正向电压 Forward Voltage	VF	1.7		2.2	V	IF=5mA
反向电流 Reverse Current	IR	-----	-----	10	μ A	VR=5V

注意:

1. 光强公差为 $\pm 15\%$
2. 正向电压公差为 $\pm 0.1\text{v}$
3. 主波长公差为 $\pm 1\text{nm}$

Note:

1. Luminous Intensity Tolerance $\pm 15\%$
2. Forward Voltage Tolerance $\pm 0.1\text{v}$
3. Dominant Wavelength Tolerance $\pm 1\text{nm}$



光电曲线 Typical Electro-Optical Characteristics Curves

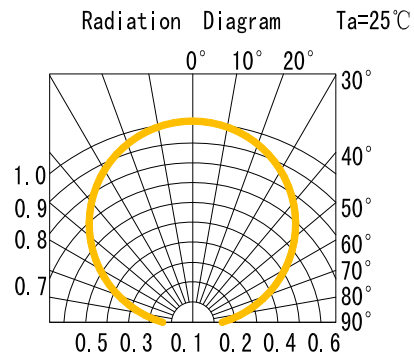
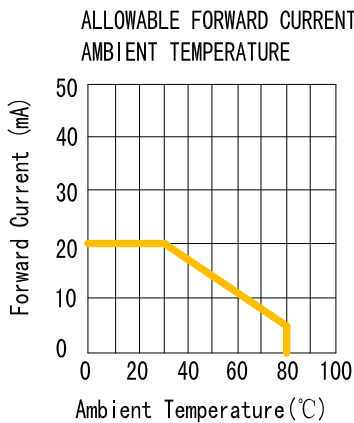
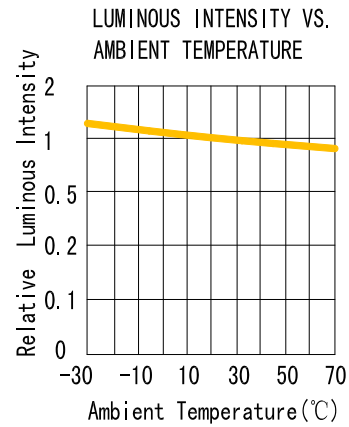
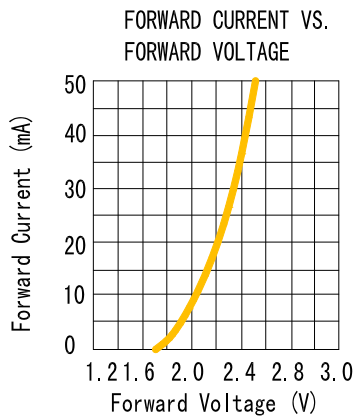
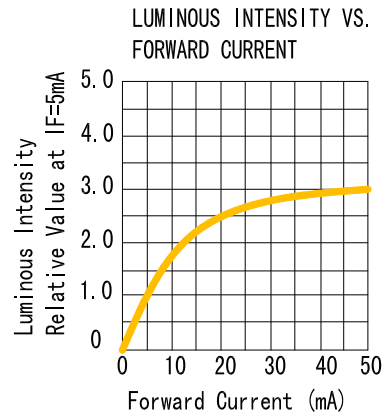
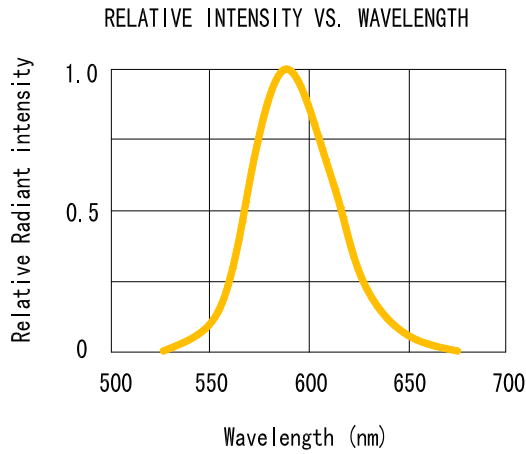

外型尺寸图 Package Outline Dimensions

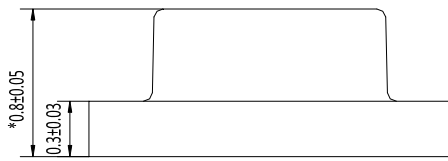
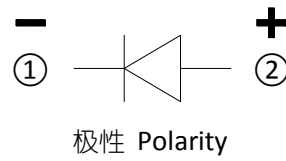
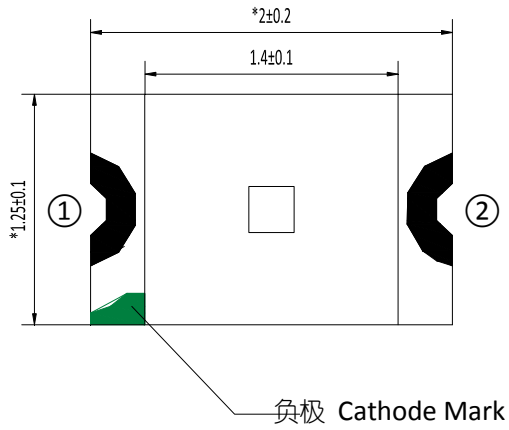

推荐焊盘尺寸
Recommend Soldering Pad

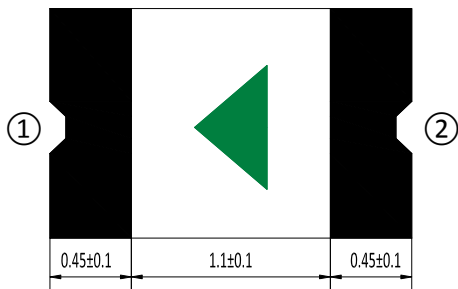
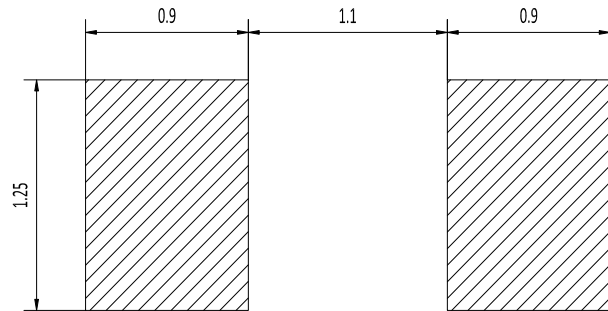

注意:

1. 单位为毫米.
2. 未标注的公差为 ± 0.1 mm.

Note:

1. All dimensions are in millimeters.
2. Tolerances unspecified are ± 0.1 mm.



包装材料 Packing Materials

标贴解释 Label Explanation

- P/N: 型号 Part Number
- QTY: 数量 Packing Quantity
- BIN: BIN 级 BIN Rank
- LOT No: 生产任务单号 Lot Number
- ERP No: ERP 单据编号 ERP Number

ARKLED 方舟科技

CODE:	XXXXXXXXXXXXXX		
P/N:	XXXXXXXXXXXXXX		
QTY:	3000PCS	BIN:	XXXXXX
LOT NO:	XXXXXXX	IV(m cd):	XXXXXX
ERP NO:	XXXXXXX	Date:	XXXXXX

料盘尺寸 Reel Dimensions

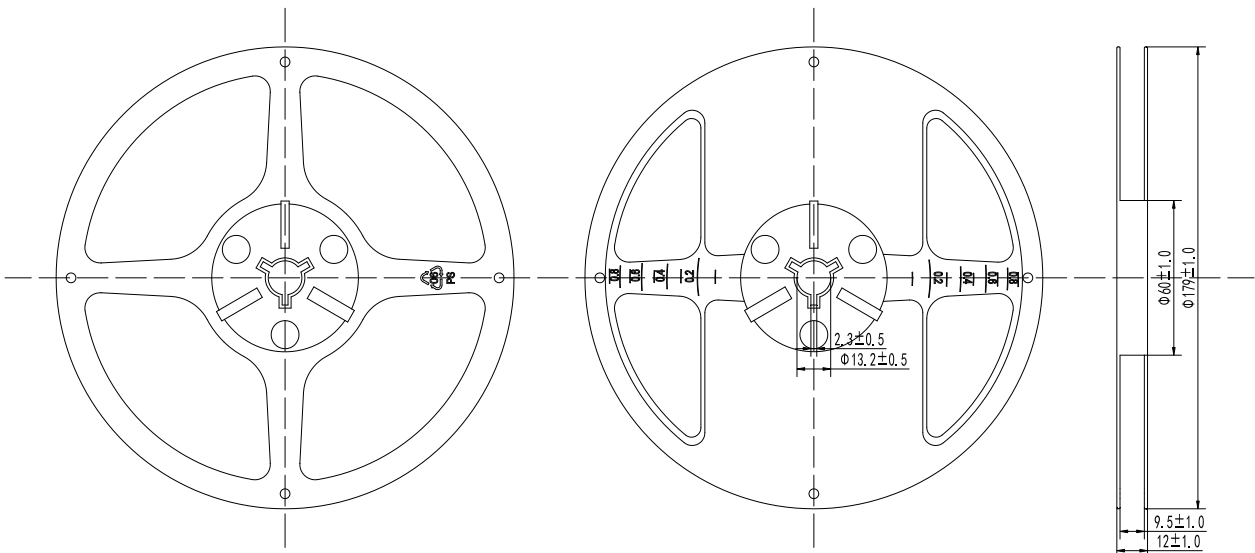

注意:

1. 单位为毫米.
2. 未标注的公差为±0.1mm.

Note:

1. All dimensions are in millimeters.
2. Tolerances unspecified are ±0.1m



包装数量：每料盘装载数量 3000 颗

Carrier Tape Dimensions: Loaded quantity 3000 PCS per reel

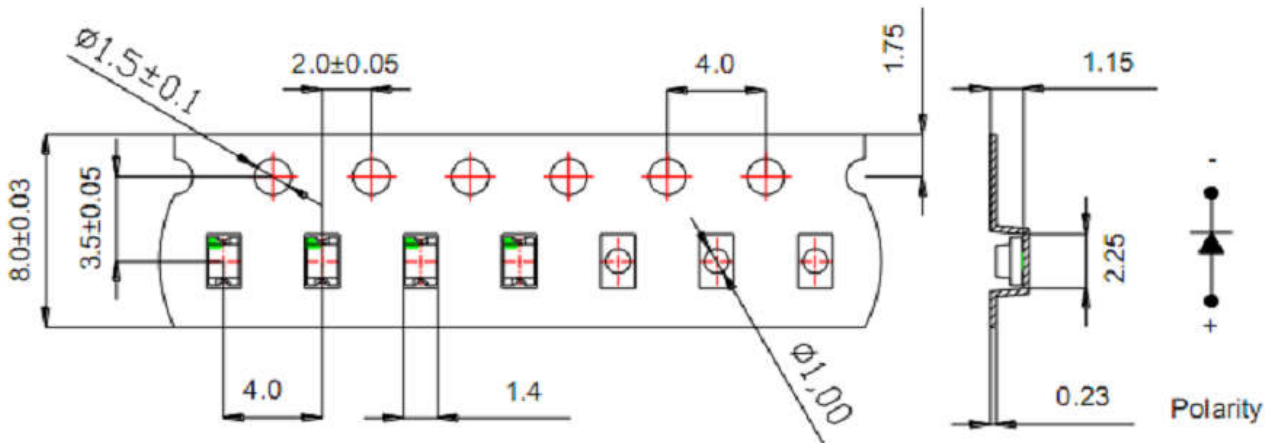

注意：

1. 单位为毫米。
2. 未标注的公差为±0.1mm.

Note:

1. All dimensions are in millimeters.
2. Tolerances unspecified are ±0.1mm.

包装 Moisture Resistant Packaging

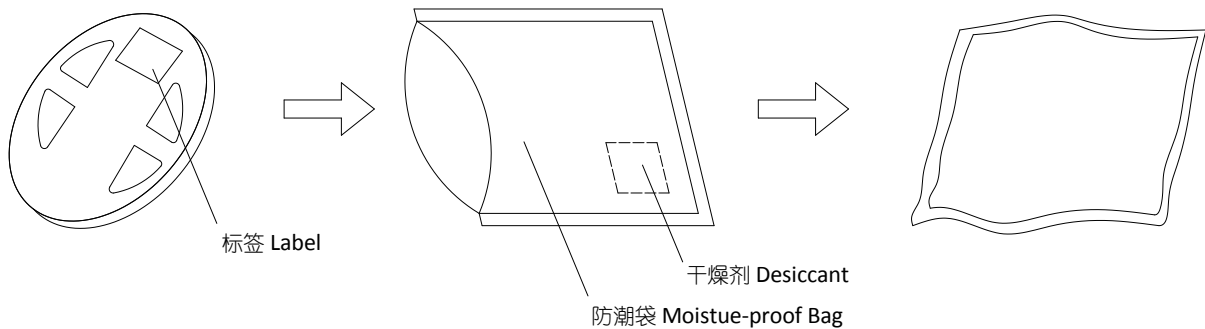



可靠性实验和条件

- 产品的可靠性必须通过以下实验。
- 置信等级：90%
- LTPD：10

Reliability Test Items And Conditions

- The reliability of products shall be satisfied with items listed below.
- Confidence level: 90%
- LTPD: 10%

项目 Items	测试条件 Test Conditions	测试时长/周期 Test Hours/Cycles	样本数量 Sample size	Ac/Re
回流焊 Reflow Soldering	260°C±5°C/5 sec	3 cycles	22 pcs	0/1
温湿度高低温交变 Temperature/Humidity Alter	80°C/90%RH 9.5Hrs ∫ 45 min -20°C 1Hr	45 cycles	22 pcs	0/1
冷热冲击 Thermal Shork	100°C 15min ∫ 5 min -40°C 15min	300 cycles	22 pcs	0/1
高温存储 High Temperature Storage	100°C	1000 Hrs	22 pcs	0/1
低温存储 Low Temperature Storage	-40°C	1000 Hrs	22 pcs	0/1
直流点亮寿命 DC Operating Life	IF = 20 mA	1000 Hrs	22 pcs	0/1
高温高湿 High Temperature / High Humidity	85°C / 85%RH	1000 Hrs	22 pcs	0/1



使用注意事项

- 过电流保护
顾客需要使用电阻进行保护, 否则轻微的电压波动会导致较大的电流改变 (有产品烧坏的可能)。
- 储藏
 1. 未使用产品之前请勿打开防潮包装袋。
 2. 产品需在一年之内使用。未使用的产品需保存在温度低于 25℃, 湿度低于 80%的环境中。
 3. 当打开包装袋后, 产品需保存在湿度低于 60%的环境中。
 4. 当打开包装袋后, 产品需在 168 小时 (7 天) 内用完。
 5. 如果产品存放超过指定期限, 需对产品进行烘烤, 烘烤条件为 60 ± 5℃ / 24 hours。
- 焊接条件
 1. 无铅回流焊温度曲线

Precautions For Use

- Over-Current-Proof
Customer must apply resistors for protection, otherwise slight voltage shift will cause big current change. (Burn out will happen)
- Storage
 1. Do not open moisture proof bag before the products are ready to use.
 2. The LEDs should be used within a year. Before opening the package, the LEDs should be kept at 25℃ or less and 80%RH or less.
 3. After opening the package, the LEDs should be kept at 60%RH or less.
 4. The LEDs should be used within 168 hours (7 days) after opening the package.
 5. If the LEDs have exceeded the storage time, baking treatment should be performed using the following conditions. Baking treatment : 60 ± 5℃ for 24 hours
- Soldering Condition
 1. Pb-free solder temperature profile

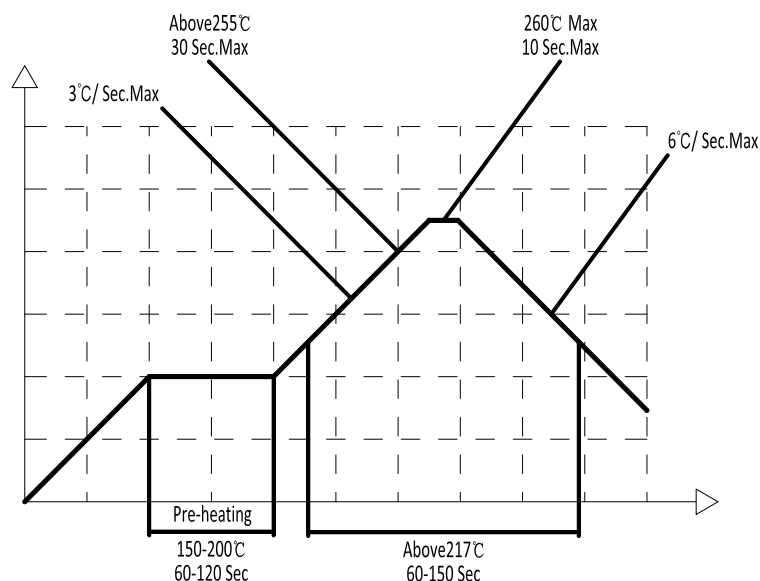



2. 不可通过二次回流焊
3. 回流焊进行时，芯片不可受力
4. 回流焊后，不可弯曲线路板

● 烙铁焊接

产品每一端的焊点必须使用功率小于 25W 的烙铁尖端焊接，烙铁温度必须低于 350℃，时间为 3 秒。间隔 2 秒或更长长时间后，才能进行另一端的焊接。请务必小心操作因为产品很容易因为手工焊接造成损伤。

● 维修

当产品已经焊接好后，一般不可维修。只有当维修不可避免时，则必须使用双头烙铁（如下图），请事先确保产品是否会因为维修而损坏。

2. Reflow soldering should not be done more than two times.
3. When soldering, do not put stress on the LEDs during heating.
4. After soldering, do not warp the circuit board.

● Soldering Iron

Each terminal is to go to the tip of soldering iron temperature less than 350℃ for 3 seconds within once in less than the soldering iron capacity 25W. Leave two seconds and more intervals, and do soldering of each terminal. Be careful because the damage of the product is often started at the time of the hand solder.

● Repairing

Repair should not be done after the LEDs have been soldered. When repairing is unavoidable, a double-head soldering iron should be used (as below figure). It should be confirmed beforehand whether the characteristics of the LEDs will or will not be damaged by repairing.

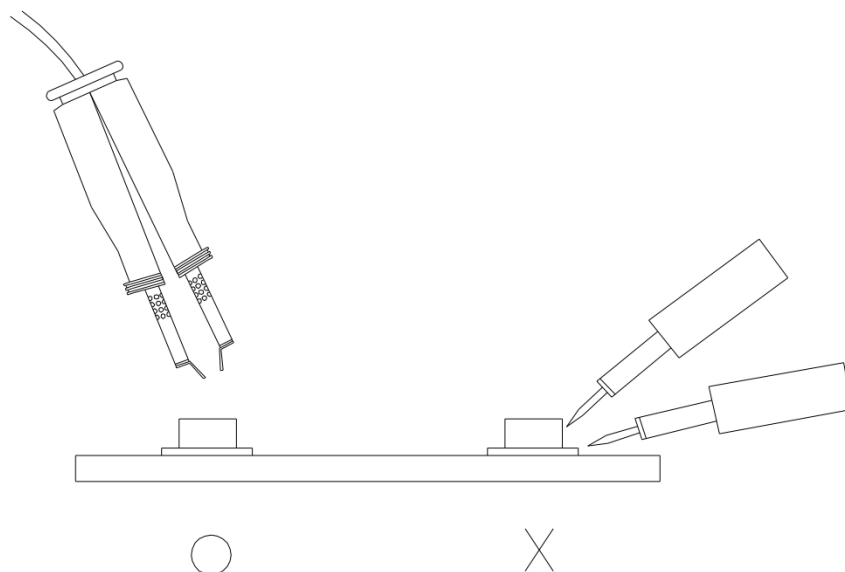



应用局限

高可靠性应用（例如：军事，航空航天，汽车安全系统，医疗设备等）可能需要更高要求的产品。如果您有任何疑问，请在使用该产品之前联系我们。此规格书仅保证该产品作为单独部件的质量和性能。请勿超出此文件对该产品规格性能描述使用。

Application Restrictions

High reliability applications such as military/aerospace, automotive safety/security systems, and medical equipment may require different product. If you have any concerns, please contact us before using this product in your application. This specification guarantees the quality and performance of the product as an individual component. Do not use this product beyond the specification described in this document.