



TOYOLED ELECTRONICS LIMITED

Unit 10-11, 19/F, Metro Loft, 38 Kwai Hei Street, Kwai Chung, N.T., Hong Kong

Tel : (852) 2540 7288

http://www.toyo-led.com

Fax : (852) 2517 1797

E-mail : sales@toyo-led.com



P/N: E20362-I-PG-8-W

2-Digits Display Series

SPECIFICATION FOR CUSTOMER APPROVAL

P/N:E20362-I-PG-8-W

DATE : March 18, 2021

PREPARED BY :



CONFIRMED BY :

PLEASE CONFIRM & SIGN BACK THIS SHEET TO US

CUSTOMER: _____

(COMPANY CHOP)

APPROVAL BY: _____

(SIGNATURE)



TOYOLED ELECTRONICS LIMITED

Unit 10-11, 19/F, Metro Loft, 38 Kwai Hei Street, Kwai Chung, N.T., Hong Kong

Tel : (852) 2540 7288
 http://www.toyo-led.com

Fax : (852) 2517 1797
 E-mail : sales@toyo-led.com



P/N: E20362-I-PG-8-W

2-Digits Display Series

PACKAGE DIMENSION

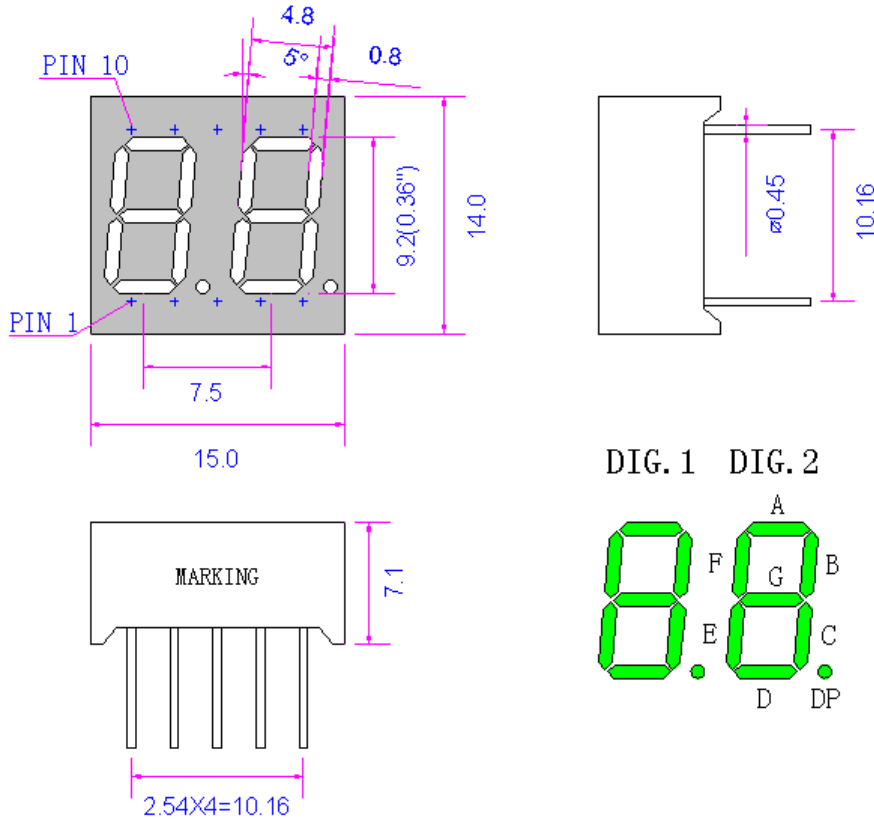

INTERNAL CIRCUIT DIAGRAM

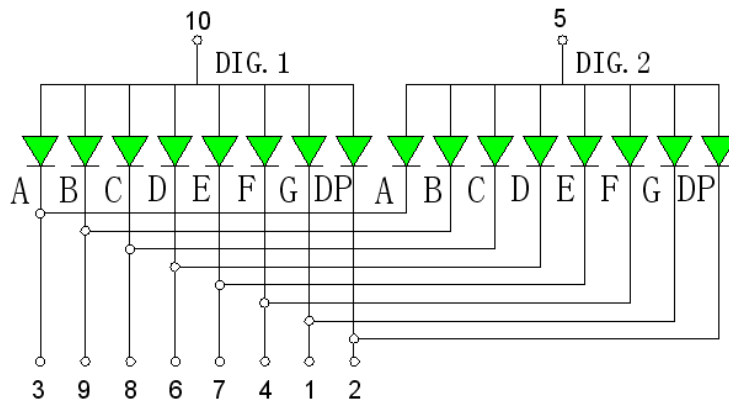

CODE I

NOTES:

1. All dimensions are in millimeter;
2. Tolerance is $\pm 0.25\text{mm}$, especially other specified;
3. Pin length, housing color, marking no & circuit diagram can be customized;
4. Specifications are subject to change without notice.
5. Not exceed 1% of the length deformation of the product



TOYOLED ELECTRONICS LIMITED

Unit 10-11, 19/F, Metro Loft, 38 Kwai Hei Street, Kwai Chung, N.T., Hong Kong
 Tel : (852) 2540 7288 Fax : (852) 2517 1797
 http://www.toyo-led.com E-mail : sales@toyo-led.com



P/N: E20362-I-PG-8-W

2-Digits Display Series

CHARACTERS

Chip Material: InGaN Pure Green LED Chip



ABSOLUTE MAXIMUM RATINGS (Ta = 25°C)

PARAMETER	SYMBOL	MAXIMUM RATING	UNIT
Power Dissipation	P _D	90	mW
Peak Forward Current (1/10 Duty Cycle, 0.1 ms Pulse Width)	I _{PEAK}	100	mA
DC Forward Current	I _F	25	mA
Reverse Voltage	V _R	5	V
Electrostatic discharge	ESD	1000	V
Operating Temperature Range	T _{opr} / T _{stg}	-40°C to +85°C	
Storage Temperature Range	T _{opr} / T _{stg}	-40°C to +100°C	

ELECTRICAL OPTICAL CHARACTER AND CURVES (Ta = 25°C)

PARAMETER	SYMBOL	MIN	TYP	MAX	UNIT	TEST CONDITION (Per Chip)
Forward Voltage	V _F	-	3.0	3.6	V	I _F = 20mA
Luminous Intensity	I _v	400	600	-	mcd	I _F = 20mA
Peak Emission Wavelength	λ _p	-	530	-	nm	I _F = 20mA
Dominant Emission Wavelength	λ _d	-	520	-	nm	I _F = 20mA
Spectral Line Half-Width	Δλ	-	30	-	nm	I _F = 20mA
Reverse Current	I _R	-	-	10	uA	V _R = 5V

Note:

- Luminous intensity tolerance is ±15%;
- Dominant Emission Wavelength tolerance is ±1nm;



P/N: E20362-I-PG-8-W

2-Digits Display Series

■ Typical Electro-Optical Characteristic Curve: PURE GREEN

FIG. 1 Forward Current Vs. Forward Voltage

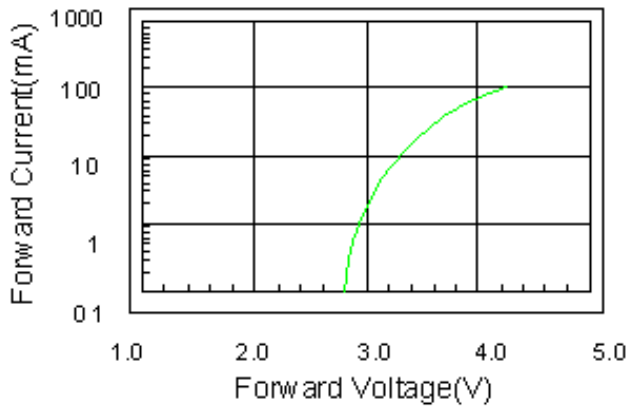

FIG. 2 Relative Intensity Vs. Forward Current

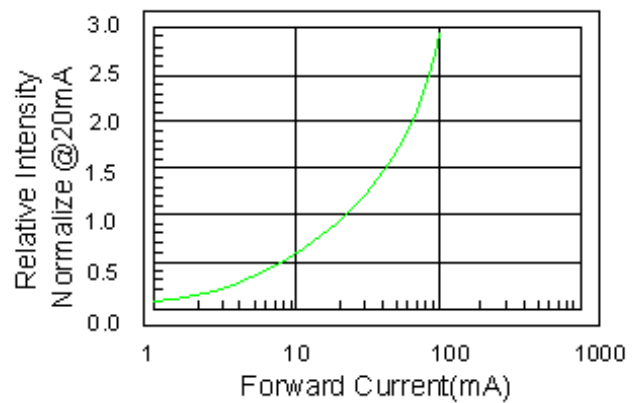

FIG. 3 Forward Voltage Vs. Temperature

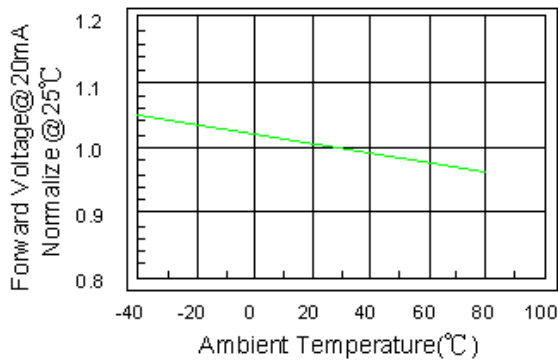

FIG. 4 Relative Intensity Vs. Temperature

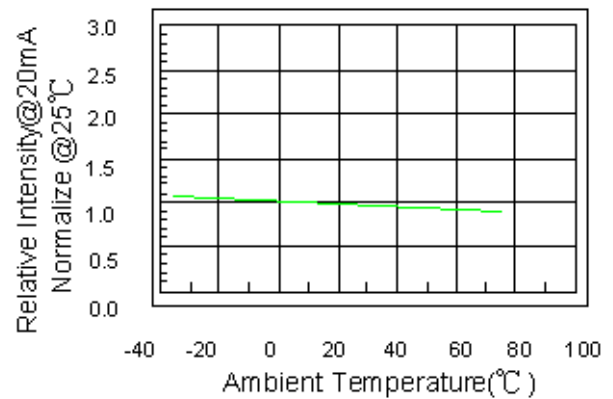
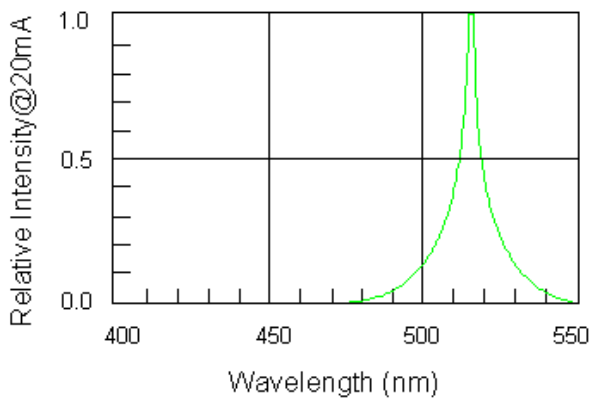

FIG. 5 Relative Intensity Vs. Wavelength





TOYOLED ELECTRONICS LIMITED

Unit 10-11, 19/F, Metro Loft, 38 Kwai Hei Street, Kwai Chung, N.T., Hong Kong

Tel : (852) 2540 7288

http://www.toyo-led.com

Fax : (852) 2517 1797

E-mail : sales@toyo-led.com



P/N: E20362-I-PG-8-W

2-Digits Display Series

Recommended Wave Soldering Profiles:

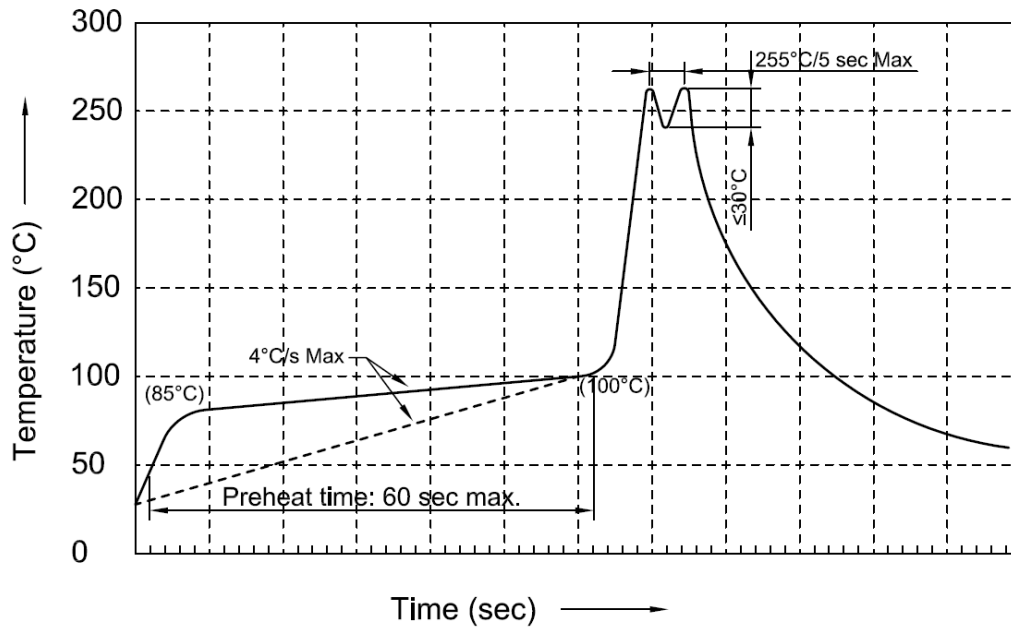

Notes:

1. Recommend pre-heat temperature of 105°C or less (as measured with a thermocouple attached to the LED pins) prior to immersion in the solder wave with a maximum solder bath temperature of 260°C.
2. Peak wave soldering temperature between 245-255°C for 3 sec (5 sec max).
3. Do not apply stress to the epoxy resin while the temperature is above 85°C.
4. Fixtures should not apply stress on the component when mounting and soldering process.
5. More than one wave soldering is not allowed.



TOYOLED ELECTRONICS LIMITED

Unit 10-11, 19/F, Metro Loft, 38 Kwai Hei Street, Kwai Chung, N.T., Hong Kong

Tel : (852) 2540 7288

http://www.toyo-led.com

Fax : (852) 2517 1797

E-mail : sales@toyo-led.com



P/N: E20362-I-PG-8-W

2-Digits Display Series

THROUGH HOLE DISPLAY MOUNTING METHOD

Lead Forming

Bend the component leads by hand without proper tools is not allowed. The leads should be bent by clinching the upper part of the lead firmly such that the bending force is not exerted on the plastic body.

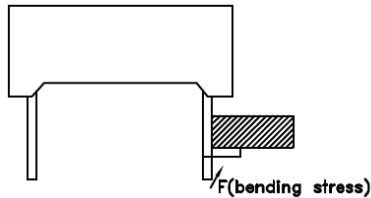

X

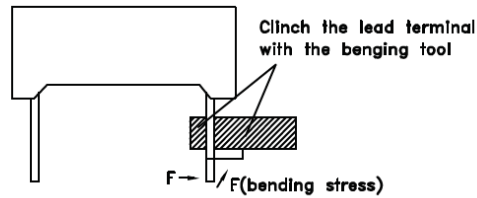

O

Installation

1. Do not apply stress to the lead terminals.
2. When inserting for assembly, ensure the terminal pitch matches the substrate board's hole pitch to prevent spreading or pinching the lead terminals.

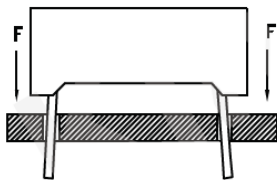

X

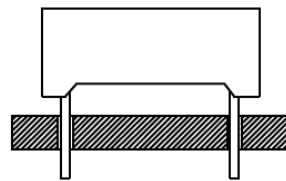

O

1. The component shall be placed at least 5mm from edge of PCB to avoid damage caused excessive heat during wave soldering.

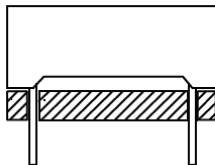

X

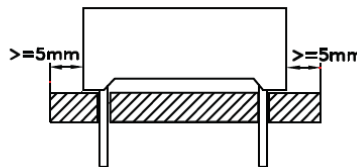

O

Storage

1. The LEDs should be stored at temp. $\leq 30^{\circ}\text{C}$ & RH. $\leq 70\%$ after being shipped from TOYO and the storage life limits are 3 months. If the LEDs are stored for 3 months or more, they can be stored for a year in a sealed container with a nitrogen atmosphere and absorbent material.
2. Please avoid rapid transitions in ambient temperature, especially in high humidity environments where condensation can occur.

Soldering General Notes

1. Through-hole displays are incompatible with reflow soldering.
2. If components will undergo multiple soldering processes where the components may be subjected to intense heat, please check with TOYO for compatibility.

Cleaning

1. Mild "no-clean" fluxes are recommended for use in soldering.
2. If cleaning is required, TOYO recommends to wash components enclosure with water only. Do not use organic solvents for cleaning, because they may damage the plastic parts. And the devices should not be washed for more than one minute.



TOYOLED ELECTRONICS LIMITED

Unit 10-11, 19/F, Metro Loft, 38 Kwai Hei Street, Kwai Chung, N.T., Hong Kong

Tel : (852) 2540 7288

http://www.toyo-led.com

Fax : (852) 2517 1797

E-mail : sales@toyo-led.com



P/N: E20362-I-PG-8-W

2-Digits Display Series

PACKING & LABEL SPECIFICATIONS

Electrostatic Discharge(ESD)

1. LEDs can be damaged by electrostatic discharge or surge current (EOS).
2. An ESD wrist strap,ESD shoe strap or antistatic gloves must be worn whenever handling LEDs.
3. Grounded properly must be applied for all devices,equipment and machinery.
4. Use ion blower to neutralize the static charge which might have built up on surface of the LEDs plastic lens as a result of friction between LEDs during storage and handing.

Other

1. Above specification may be changed without notice. TOYO will reserve authority on material change for above specification.
2. When using this product, please observe the absolute maximum ratings and the instructions for using outlined in these specification sheets. TOYO assumes no responsibility for any damage resulting from use of the product which does not comply with the absolute maximum ratings and the instructions included in these specification sheets.
3. These specification sheets include materials protected under copyright of TOYO LED ELECTRONICS LIMITED. Please don't reproduce cause by anyone to reproduce them without TOYO's consent.

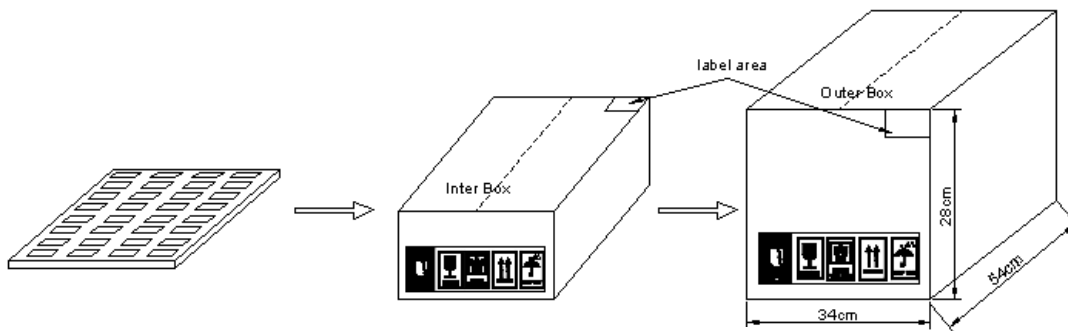

Notes:

1. All dimension are in millimeter;
2. Tolerance is $\pm 0.25\text{mm}$ unless otherwise specified.
3. Not recommend to solder within 3mm from the resin.



TOYOLED ELECTRONICS LIMITED

Unit 10-11, 19/F, Metro Loft, 38 Kwai Hei Street, Kwai Chung, N.T., Hong Kong

Tel : (852) 2540 7288
http://www.toyo-led.com

Fax : (852) 2517 1797
E-mail : sales@toyo-led.com



P/N: E20362-I-PG-8-W

2-Digits Display Series

REVISION HISTORY

DATE	REVISION CONTENTS	VERSION
2021.03.18	Initial release	A