

# R13-73

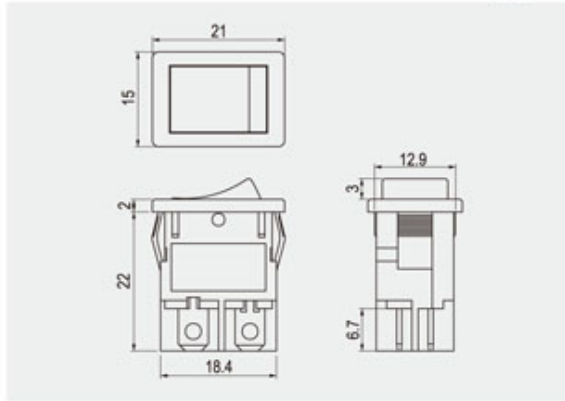

<b>Rating</b>
10A 125V AC 6A 250V AC
<b>Contact resistance</b>
50mΩ Max
<b>Insulation resistance</b>
DC 500V 100MΩ Min
<b>Dielectric strength</b>
AC 1500V 1 minute
<b>Cut-out</b>

## FEATURES

- \* MATERIAL: Frame is nylon (UL flame: 94V-2). Terminals are silver plated brass.
- \* Illuminated actuators are molded in PC, available with red, amber, green, blue and white colors.
- \* Snap-in mounting, easy to install switch into panel.
- \* Lower rating than R13-73 A series.

	X	Y
$\frac{22}{22}$	X	Y
0.75-1.25	19.2-0.1	13.0+0.1
1.25-2	19.4-0.1	13.0+0.1
2-3	19.8-0.1	13.0+0.1

## Ordering number instruction

R13-73  -

FUNCTION				TERMINAL	
<b>Different button (按钮不同)</b>				0 2  .187" SQ	
<b>A</b>		<b>A 2</b>		0 9  PC	
<b>Illuminated button (带灯)</b>				1 0  PC ANGLE	
<b>B</b>		<b>C</b>			
OFF ON 4P DPST		OFF ON 3P SPST (NEON) 125VAC 33KΩ / 250VAC 150KΩ		OFF ON 4P DPST (NEON) 125VAC 33KΩ / 250VAC 150KΩ	



# ORDERING MENU

COMPANY

NAME & DATE

[ ] [ ] [ ]			[ ] [ ] [ ] [ ] [ ] [ ]				[ ] [ ]		1 2 3 4				5 5 6			7	8
PRODUCT SERIES CODE			MODEL NO.				TERMINAL TYPE		COLOR				PRINT & PACKAGE			LAMP	VOLTAGE



## 1 FRAME COLOR

B BLACK   
  W WHITE   
  R RED   
  Y YELLOW   
  U BLUE   
  G GREEN   
  O OTHER

## 2 ACTUATOR COLOR

ACTUATOR COLOR

B BLACK   
  W WHITE   
  R RED   
  Y YELLOW   
  U BLUE   
  G GREEN   
  O OTHER

TOGGLE COLOR

B BLACK   
  W WHITE   
  R RED   
  Y YELLOW   
  U BLUE   
  G GREEN   
  O OTHER

1 NICKEL   
  2 BLACK NICKEL   
  3 CHROMIUM   
  4 BLACK CHROMIUM

## 3 SECOND BUILD-IN ACTUATOR COLOR OR LENS COLOR

SECOND BUILD-IN ACTUATOR COLOR

B BLACK   
  W WHITE   
  R RED   
  Y YELLOW   
  U BLUE   
  G GREEN   
  N NONE

SECOND LENS COLOR

B BLACK   
  W WHITE   
  R RED   
  Y YELLOW   
  U BLUE   
  G GREEN   
  N NONE   
  C CLEAR

## 4 ANOTHER LENS COLOR OR LED COLOR

LENS COLOR

B BLACK   
  W WHITE   
  R RED   
  Y YELLOW   
  U BLUE   
  G GREEN   
  N NONE   
  C CLEAR

LED COLOR

R RED   
  Y YELLOW   
  G GREEN   
  A AMBER   
  L BLUE   
  W WHITE   
  N NONE   
  O OTHER

## 5 PRINT

### MARKING PRINTED OR LASER ENGRAVED ON ACTUATOR

\* Contact SCI for availability for each item.

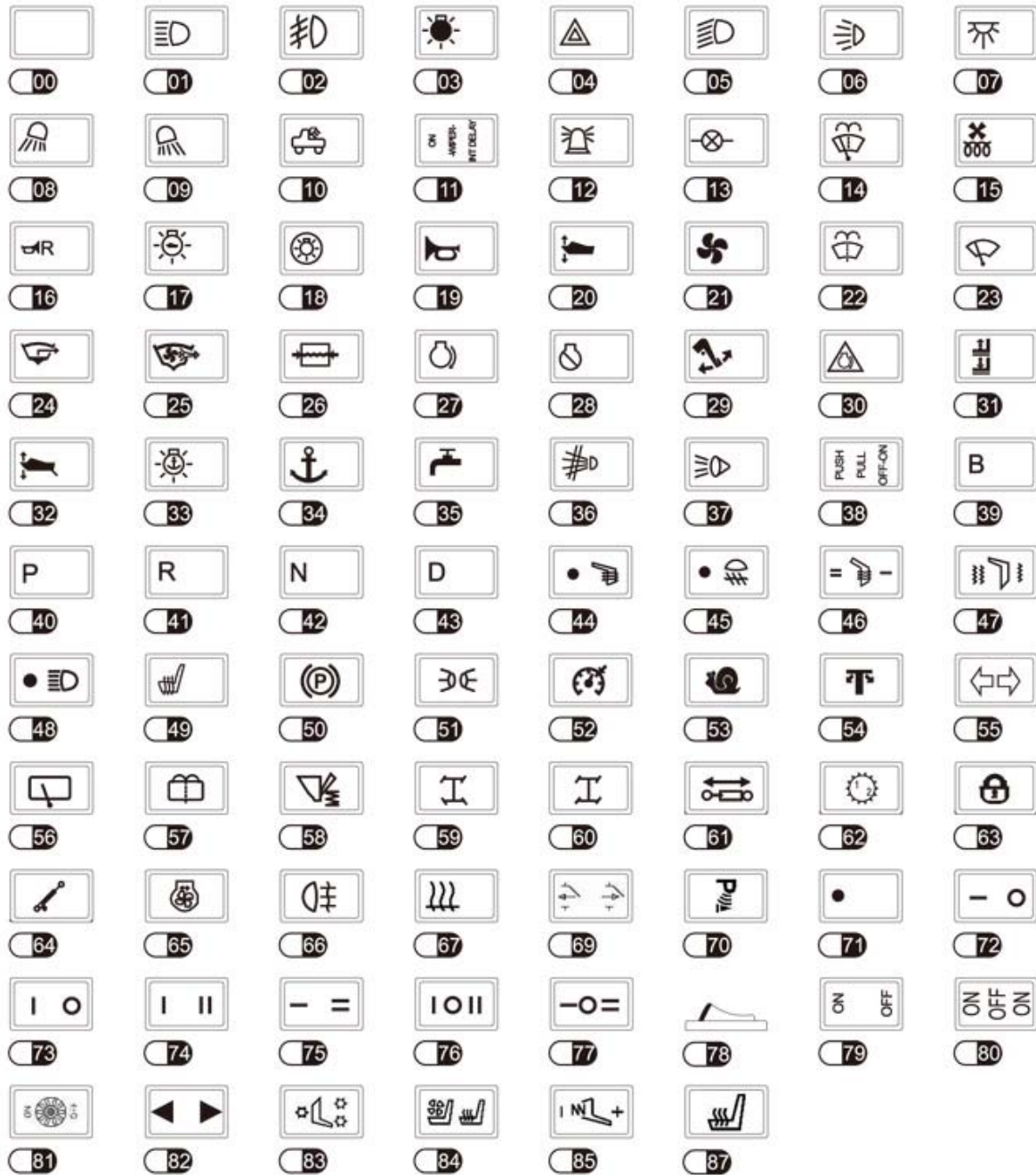

## 6 PACKAGE

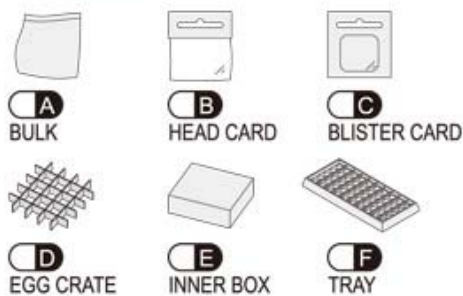

## 7 LAMP

## 8 VOLTAGE

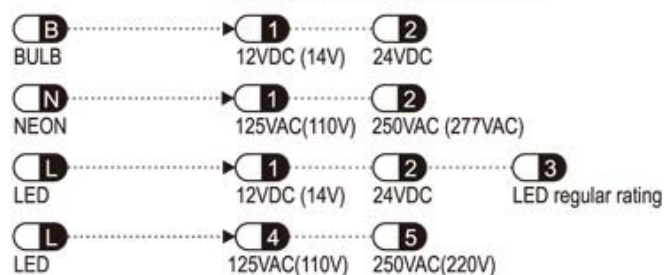

► For details of LED regular voltage, please contact sales dept.





# TERMINAL TYPE



0 1  .250" SQ Quick connect  
  
 6.3\*0.8t

0 2  .187" SQ Quick connect  
  
 4.8\*0.8t

0 3  .110" SQ Quick connect  
  
 2.8\*0.8t

0 4  SAE SQ Quick connect  
  
 6.3\*0.8t (SAE)

0 5  SO Solder  

0 6  SC 3 Screw  
  
 M3 Screw

0 7  SC 4 Screw  
  
 M4 Screw

0 8  SC 6-32UNC Screw  
  
 No. 6-32 UNC

0 9  PC PC mounting  

1 0  PC ANGLE PC mounting  
  
 Angle

1 1  WIRE Wire  

1 2  SO Solder  

1 3  .187" SQ Quick connect  
  
 4.8\*0.5t