

Enable High Flux and Cost Efficient System

## Z Power Chip on board – ZC series

**SDW\*5F1C (SDW05F1C, SDW85F1C, SDW95F1C)**



## Product Brief

### Description

- The ZC series are LED arrays which provide High Flux and High Efficacy.
- It is especially designed for easy assembly of lighting fixtures by eliminating reflow soldering process.
- It's thermal management is better than other power LED solutions with wide Metal area.
- ZC series are ideal light sources for General Lighting applications including Replacement Lamps, Industrial & Commercial Lightings and other high Lumen required applications.

### Features and Benefits

- Size 28mm \* 28mm
- Power dissipation 35.8 ~ 74W
- Wide CCT range with CRI70~90
- Forward current typ 36.1V
- Maximum Current 1.84A
- MacAdam 3-step binning
- Uniformed Shadow
- Excellent Thermal management
- RoHS compliant

### Key Applications

- Commercial – Downlight
- Industrial – High/Low Bay lighting
- Residential
- Replacement lamps – Bulb, PAR
- Outdoor area – Street lighting, Tunnel lighting, Parking area lighting

**Table 1. Product Selection Table**

Part Number	CCT [K]			
	Color	Min.	Typ.	Max.
SDW05F1C	Cool White	4,700	-	6,000
	Neutral White	3,700	-	4,700
SDW85F1C	Cool White	4,700	-	6,000
	Neutral White	3,700	-	4,700
	Warm White	2,600	-	3,700
SDW95F1C	Neutral White	3,700	-	4,200
	Warm White	2,600	-	3,700

---

# Table of Contents

<b>Index</b>	
• Product Brief	1
• Table of Contents	2
• Performance Characteristics	3
• Characteristics Graph	6
• Color Bin Structure	14
• Mechanical Dimensions	19
• Packaging Specification	20
• Product Nomenclature (Labeling Information)	22
• Handling of Silicone Resin for LEDs	23
• Precaution For Use	24
• Company Information	27

---

## Performance Characteristics

**Table 2. Electro Optical Characteristics,  $T_j=25^{\circ}\text{C}$** 

Part Number	CCT (K) <sup>[1]</sup>	Typical Luminous Flux <sup>[2]</sup> , $\Phi_v$ <sup>[3]</sup> (lm)		Typical Forward Voltage, $V_F$ <sup>[4]</sup> (V)		CRI <sup>[5]</sup> , $R_a$	Viewing Angle (degrees) $2\theta_{1/2}$
	Typ.	1A	1.84A*	1A	1.84A*	Min.	Typ.
SDW05F1C	5600	5497	8685	36.1	37.8	70	120
	5000	5555	8777	36.1	37.8	70	120
	4500	5767	9112	36.1	37.8	70	120
	4000	5750	9085	36.1	37.8	70	120
SDW85F1C	5600	5102	7857	36.1	37.8	80	120
	5000	5189	7990	36.1	37.8	80	120
	4000	5224	8034	36.1	37.8	80	120
	3500	5156	7930	36.1	37.8	80	120
	3000	5040	7751	36.1	37.8	80	120
	2700	4929	7581	36.1	37.8	80	120
SDW95F1C	4000	4440	5639	36.1	37.8	90	120
	3500	4449	5651	36.1	37.8	90	120
	3000	4305	5467	36.1	37.8	90	120
	2700	3961	5030	36.1	37.8	90	120

**Notes :**

- (1) Correlated Color Temperature is derived from the CIE 1931 Chromaticity diagram. Color coordinate :  $\pm 0.005$ , CCT  $\pm 5\%$  tolerance.
- (2) Seoul Semiconductor maintains a tolerance of  $\pm 7\%$  on flux and power measurements.
- (3)  $\Phi_v$  is the total luminous flux output as measured with an integrating sphere.
- (4) Tolerance is  $\pm 3\%$  on forward voltage measurements.
- (5) Tolerance is  $\pm 2$  on CRI measurements.

\* No values are provided by real measurement. Only for reference purpose.

## Performance Characteristics

**Table 3. Electro Optical Characteristics,  $T_j=85^{\circ}\text{C}$** 

Part Number	CCT (K) <sup>[1]</sup>	Typical Luminous Flux <sup>[2]</sup> , $\Phi_v$ <sup>[3]</sup> (lm)	Typical Forward Voltage, $V_f$ <sup>[4]</sup> (V)
	Typ.	1A *	1A *
SDW05F1C	5600	4975	34.6
	5000	5027	34.6
	4500	5219	34.6
	4000	5204	34.6
SDW85F1C	5600	4592	34.6
	5000	4670	34.6
	4000	4702	34.6
	3500	4640	34.6
	3000	4536	34.6
	2700	4436	34.6
SDW95F1C	4000	3885	34.6
	3500	3893	34.6
	3000	3767	34.6
	2700	3466	34.6

**Notes :**

- (1) Correlated Color Temperature is derived from the CIE 1931 Chromaticity diagram. Color coordinate :  $\pm 0.005$ , CCT  $\pm 5\%$  tolerance.
- (2) Seoul Semiconductor maintains a tolerance of  $\pm 7\%$  on flux and power measurements.
- (3)  $\Phi_v$  is the total luminous flux output as measured with an integrating sphere.
- (4) Tolerance is  $\pm 3\%$  on forward voltage measurements.
- (5) Tolerance is  $\pm 2$  on CRI measurements.

\* No values are provided by real measurement. Only for reference purpose.

## Performance Characteristics

**Table 4. Absolute Maximum Characteristics,  $T_j=25^{\circ}\text{C}$** 

Parameter	Symbol	Value			Unit
		Min.	Typ.	Max.	
Forward Current	$I_F$	-	1	1.84	A
Power Dissipation	$P_d$	-	35.8	74	W
Junction Temperature	$T_j$	-	-	140	$^{\circ}\text{C}$
Operating Temperature	$T_{opr}$	-40	-	85	$^{\circ}\text{C}$
Surface Temperature	$T_s$	-	-	100	$^{\circ}\text{C}$
Storage Temperature	$T_{stg}$	-40	-	100	$^{\circ}\text{C}$
Thermal resistance (J to S) <sup>[1]</sup>	$R_{th_{JS}}$	-	0.48	-	K/W
ESD Sensitivity(HBM)	-	Class 3A JESD22-A114-E			

**Notes :**

(1) Thermal resistance :  $R_{th_{JS}}$  (Junction / solder)

- LED's properties might be different from suggested values like above and below tables if operation condition will be exceeded our parameter range. Care is to be taken that power *dissipation does not* exceed the absolute maximum rating of the product.
- Thermal resistance can be increased substantially depending on the heat sink design/operating condition, and the maximum possible driving current will decrease accordingly.
- All measurements were made under the standardized environment of Seoul Semiconductor.

## Characteristics Graph

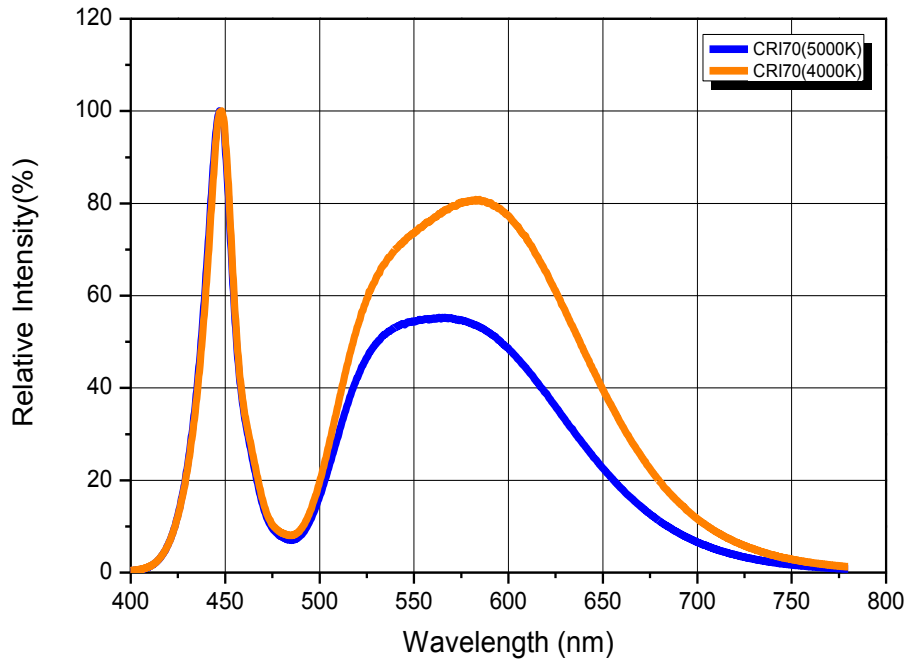
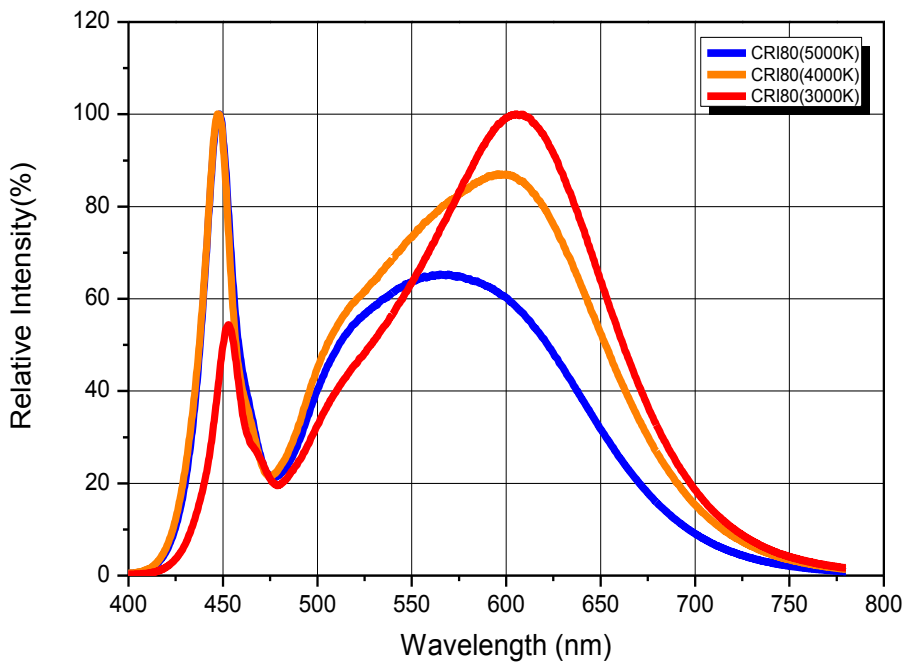
**Fig 1. Color Spectrum,  $T_j=25^{\circ}\text{C}$ ,  $I_F=1\text{A}$  (CRI70)**

**Fig 2. Color Spectrum,  $T_j=25^{\circ}\text{C}$ ,  $I_F=1\text{A}$  (CRI80)**

## Characteristics Graph

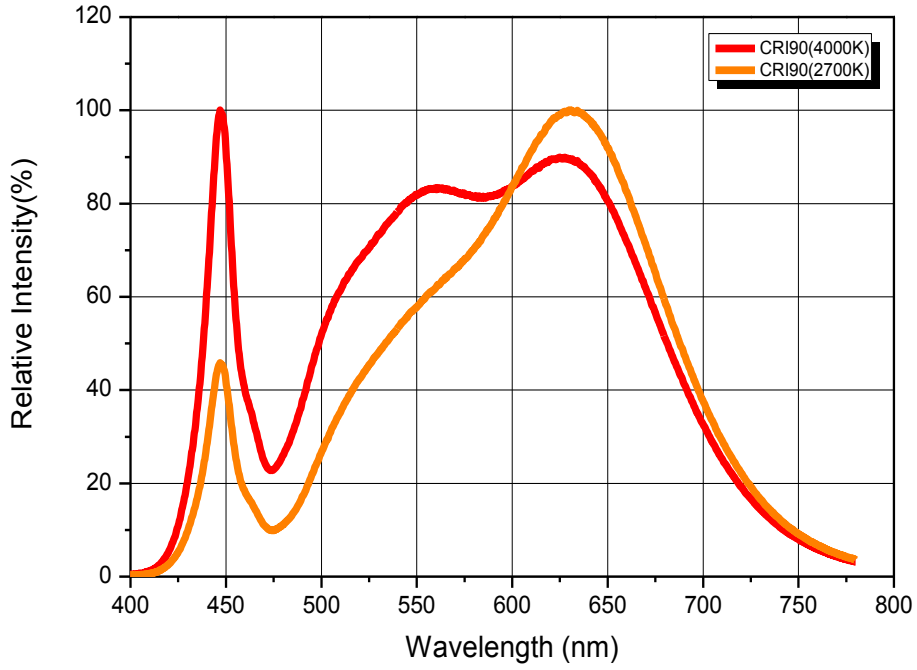
Fig 3. Color Spectrum,  $T_j=25^{\circ}\text{C}$ ,  $I_F=1\text{A}$  (CRI90)



## Characteristics Graph

Fig 4. Radiant pattern,  $T_j=25^{\circ}\text{C}$ ,  $I_F=1\text{A}$

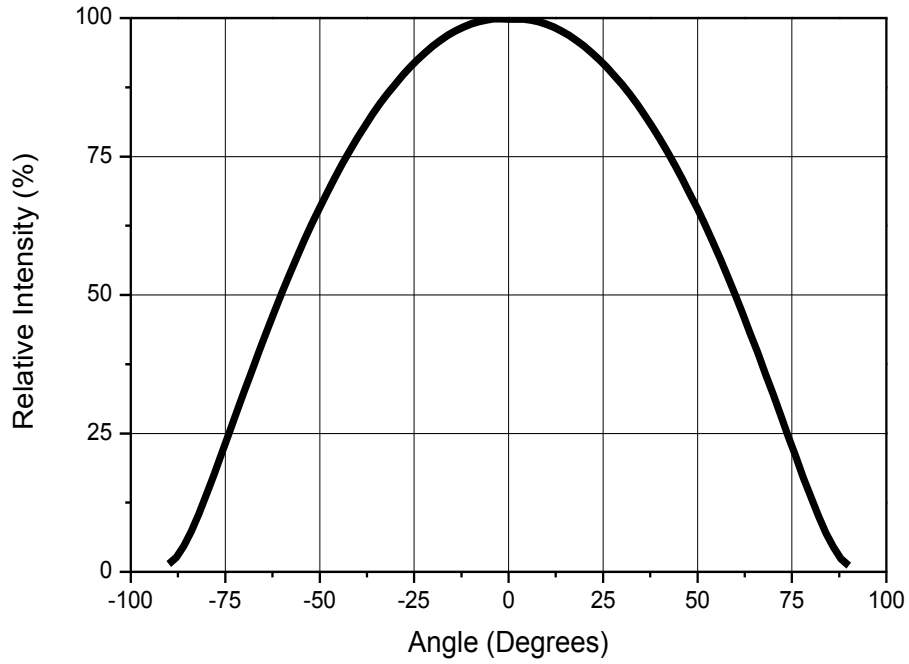

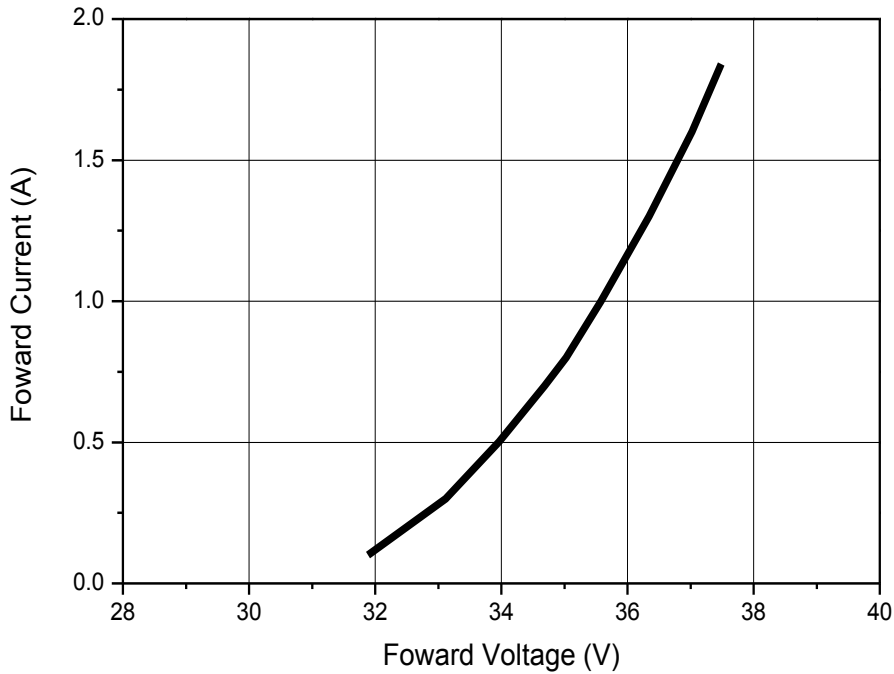
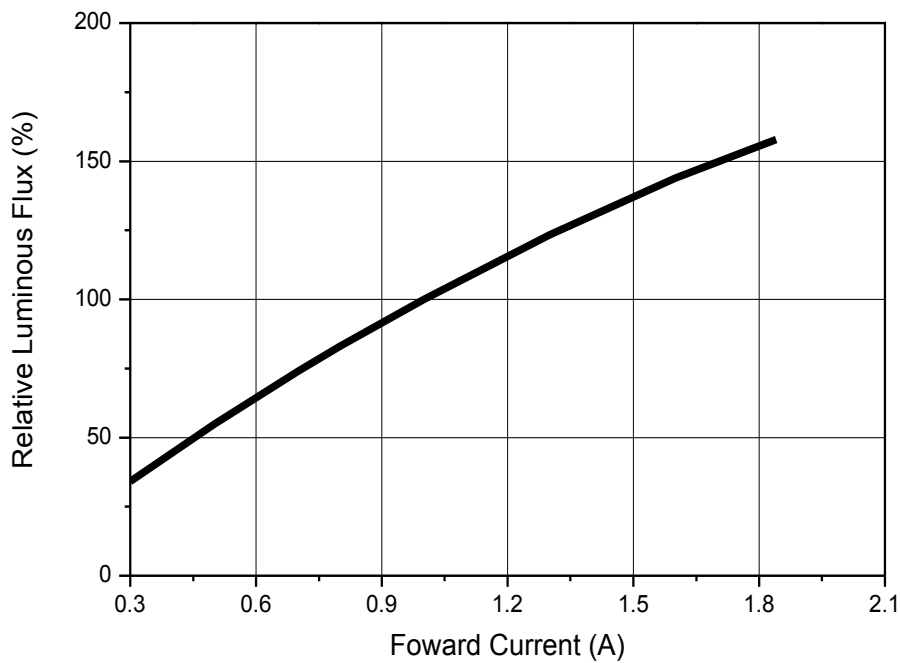

## Characteristics Graph

**Fig 5. Forward Voltage vs. Forward Current,  $T_j=25^\circ\text{C}$** 

**Fig 6. Forward Current vs. Relative Luminous Flux,  $T_j=25^\circ\text{C}$** 

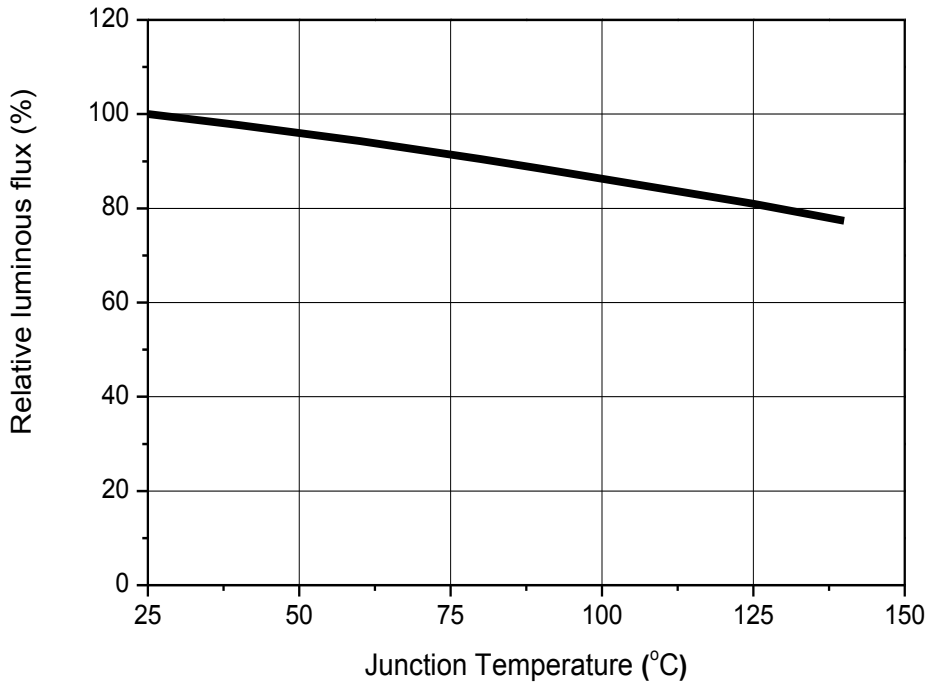
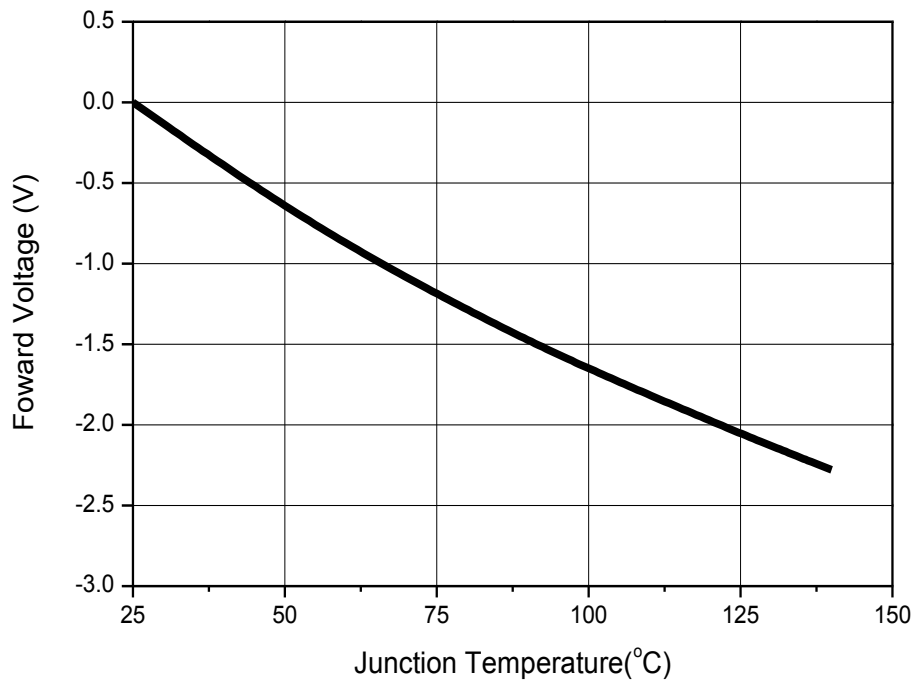
## Characteristics Graph

**Fig 7. Junction Temperature vs. Relative Light Output,  $I_F=1A$** 

**Fig 8. Junction Temperature vs. Forward Voltage,  $I_F=1A$** 

## Characteristics Graph

Fig 9. Junction Temperature vs. CIE X, Y Shift,  $I_F=1A$  (CRI70)

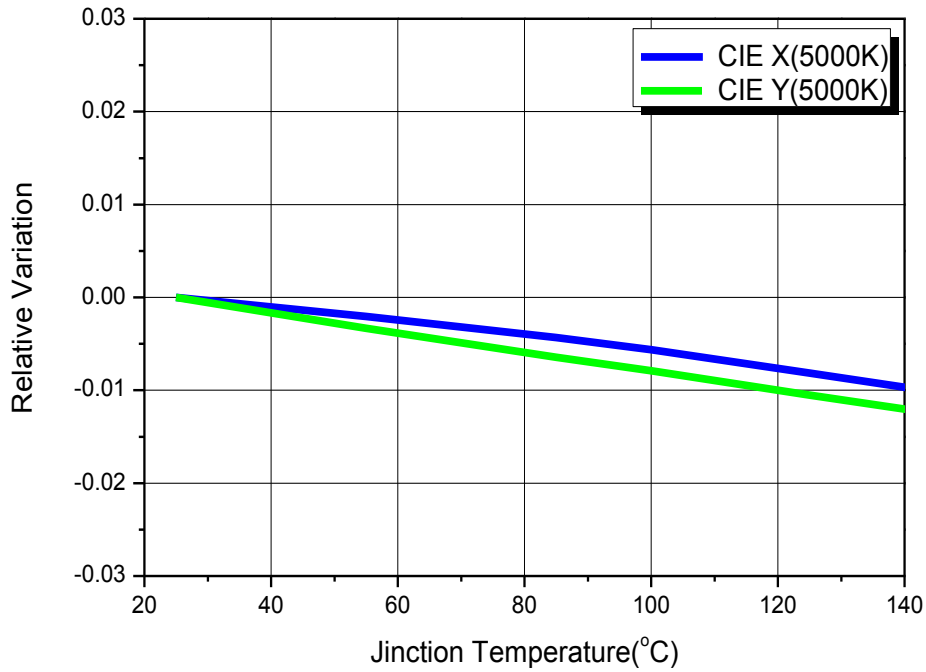
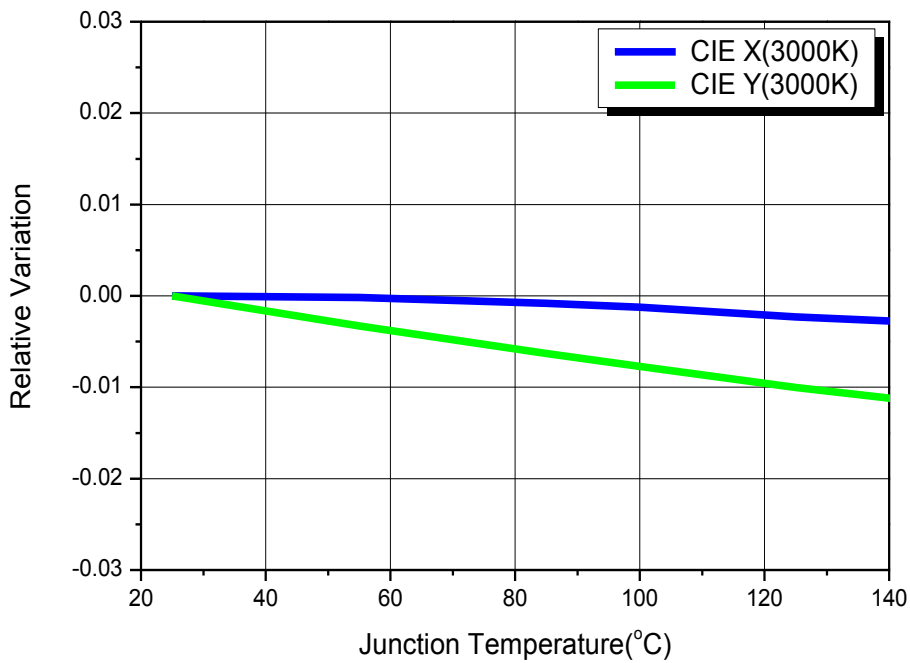
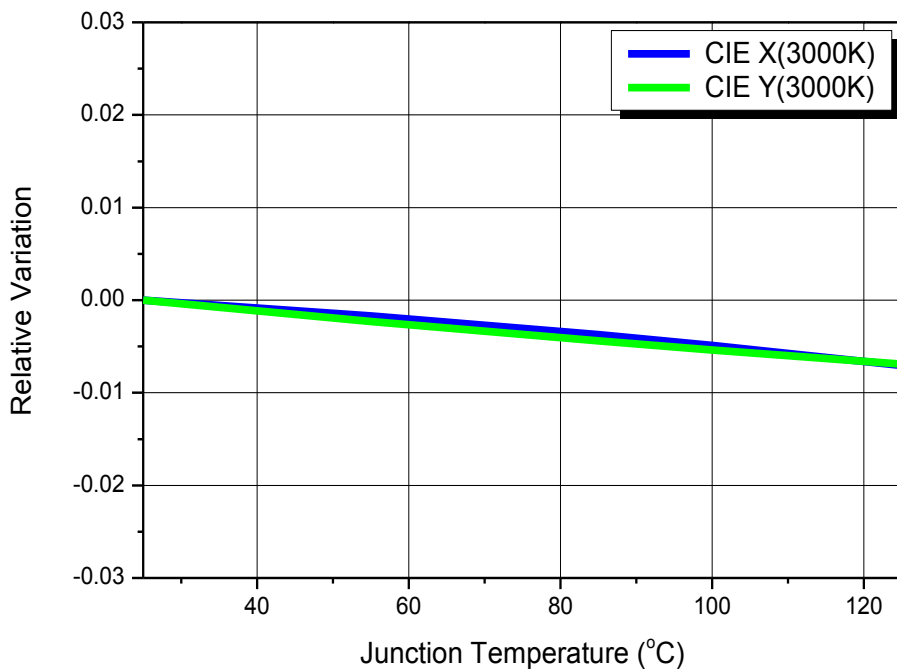
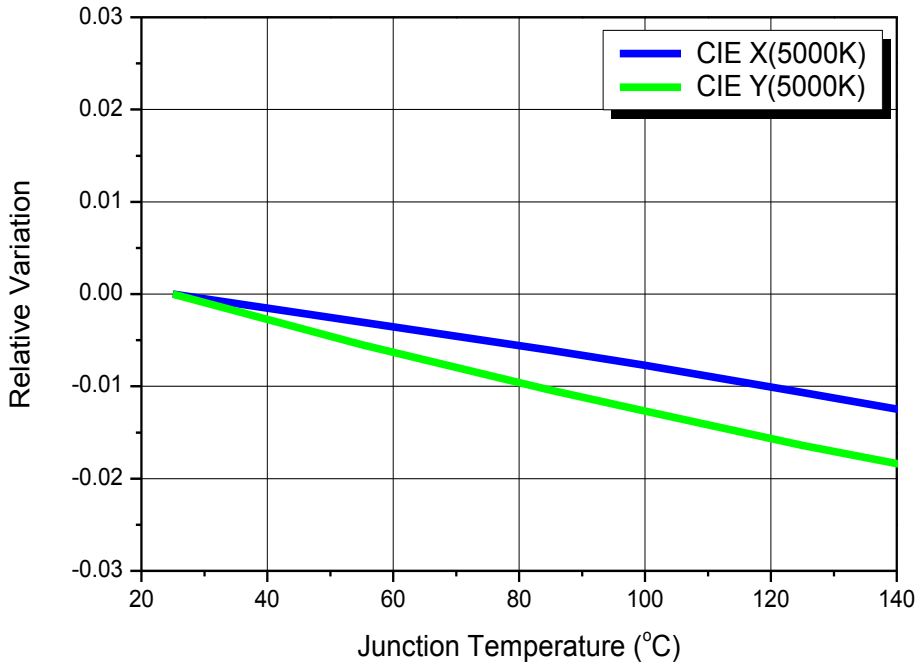

Fig 10. Junction Temperature vs. CIE X, Y Shift,  $I_F=1A$  (CRI90)



## Characteristics Graph

Fig 11. Junction Temperature vs. CIE X, Y Shift,  $I_F=1A$  (CRI80)



## Characteristics Graph

Fig 12. Surface Temperature vs. Maximum Forward Current,  $T_j(\text{max.})=140^\circ\text{C}$

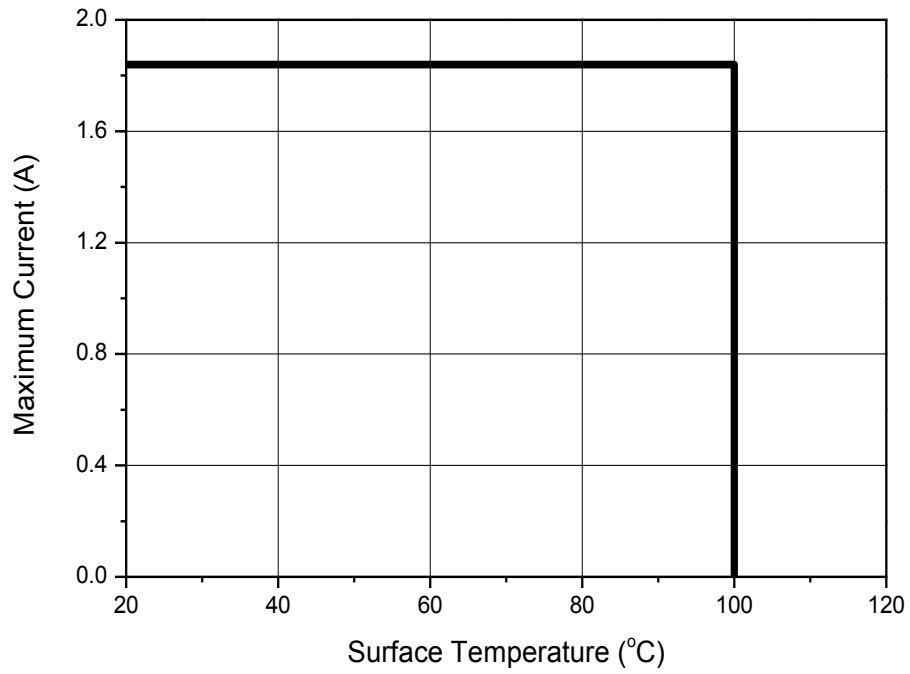

## Color Bin Structure

**Table 7. Bin Code description**

Part Number	Luminous Flux (lm) @ I <sub>F</sub> = 1A			Color Chromaticity Coordinate @ I <sub>F</sub> = 1A	Typical Forward Voltage (V <sub>F</sub> ) @ I <sub>F</sub> = 1A		
	Bin Code	Min.	Max.		Bin Code	Min.	Max.
SDW05F1C	K2	4500	5100	Refer to page.15~18	E	34.0	38.0
	L1	5100	5800		F	38.0	40.0
	L2	5800	6600				
SDW85F1C	K1	3900	4500	Refer to page.15~18	E	34.0	38.0
	K2	4500	5100		F	38.0	40.0
	L1	5100	5800				
SDW95F1C	J1	2900	3400	Refer to page.15~18	E	34.0	38.0
	J2	3400	3900		F	38.0	40.0
	K1	3900	4500				

**Table 8. Ordering Information(Bin Code)**
Available ranks

Part Number	CCT	CIE	LF rank			VF rank	
SDW05F1C	5300~6000K	B	K2	L1	L2	E	F
	4700~5300K	C	K2	L1	L2	E	F
	4200~4700K	D	K2	L1	L2	E	F
	3700~4200K	E	K2	L1	L2	E	F
SDW85F1C	5300~6000K	B	K1	K2	L1	E	F
	4700~5300K	C	K1	K2	L1	E	F
	3700~4200K	E	K1	K2	L1	E	F
	3200~3700K	F	K1	K2	L1	E	F
	2900~3700K	G	K1	K2	L1	E	F
	2600~2900K	H	K1	K2	L1	E	F
SDW95F1C	3700~4200K	E	J1	J2	K1	E	F
	3200~3700K	F	J1	J2	K1	E	F
	2900~3700K	G	J1	J2	K1	E	F
	2600~2900K	H	J1	J2	K1	E	F

## Color Bin Structure

CIE Chromaticity Diagram

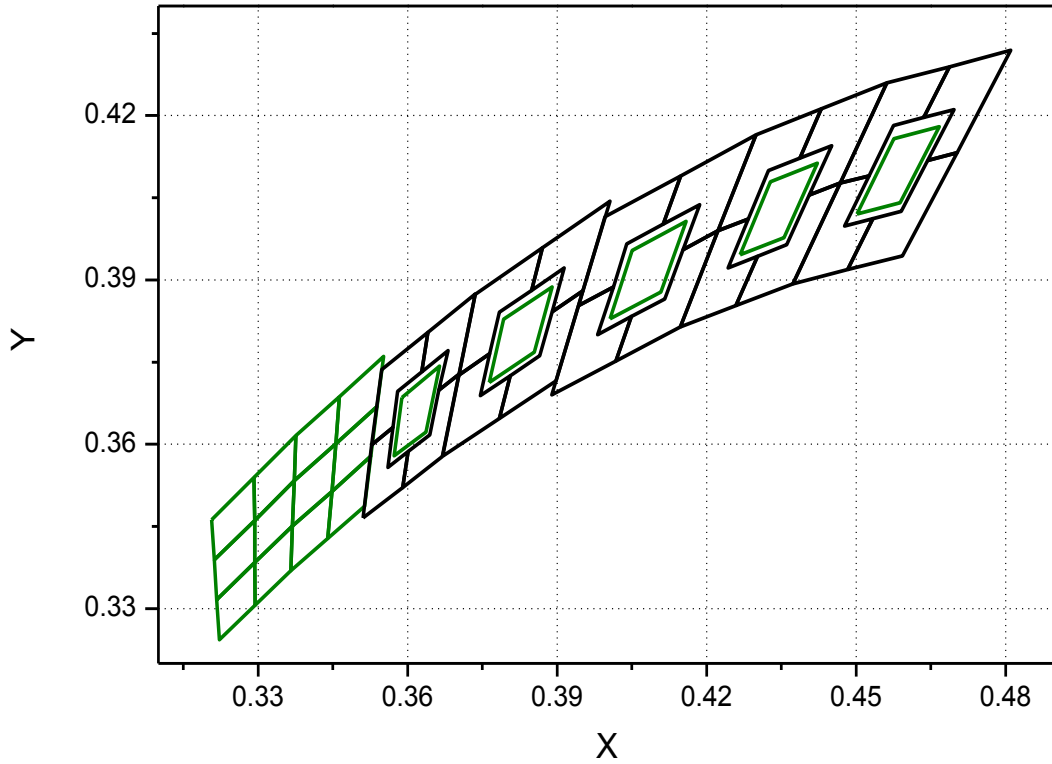

## Color Bin Structure

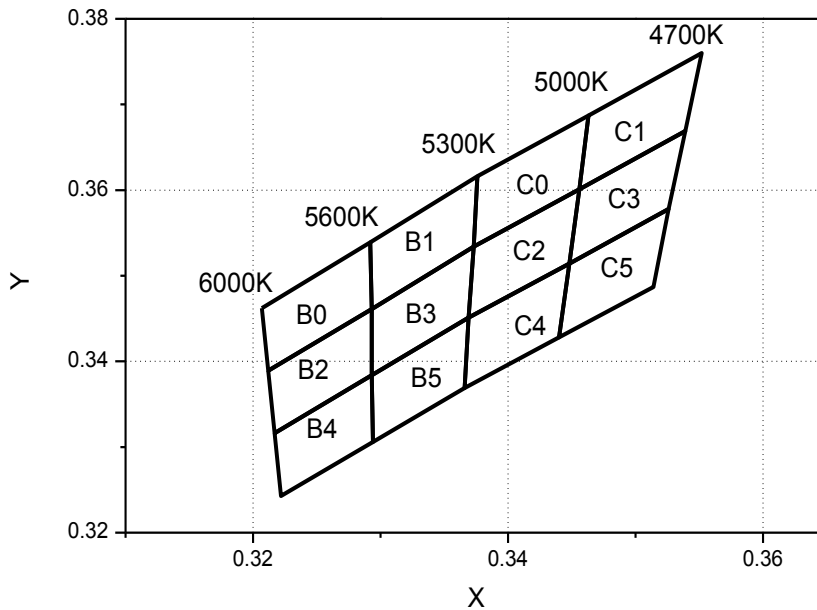
**CIE Chromaticity Diagram,  $T_j=25^{\circ}\text{C}$ ,  $I_f=1\text{A}$** 

B0		B1		B2	
CIE x	CIE y	CIE x	CIE y	CIE x	CIE y
0.3207	0.3462	0.3292	0.3539	0.3212	0.3389
0.3212	0.3389	0.3293	0.3461	0.3217	0.3316
0.3293	0.3461	0.3373	0.3534	0.3293	0.3384
0.3292	0.3539	0.3376	0.3616	0.3293	0.3461
B3		B4		B5	
CIE x	CIE y	CIE x	CIE y	CIE x	CIE y
0.3293	0.3461	0.3217	0.3316	0.3293	0.3384
0.3293	0.3384	0.3222	0.3243	0.3294	0.3306
0.3369	0.3451	0.3294	0.3306	0.3366	0.3369
0.3373	0.3534	0.3293	0.3384	0.3369	0.3451
C0		C1		C2	
CIE x	CIE y	CIE x	CIE y	CIE x	CIE y
0.3376	0.3616	0.3463	0.3687	0.3373	0.3534
0.3373	0.3534	0.3456	0.3601	0.3369	0.3451
0.3456	0.3601	0.3539	0.3669	0.3448	0.3514
0.3463	0.3687	0.3552	0.3760	0.3456	0.3601
C3		C4		C5	
CIE x	CIE y	CIE x	CIE y	CIE x	CIE y
0.3456	0.3601	0.3369	0.3451	0.3448	0.3514
0.3448	0.3514	0.3366	0.3369	0.3440	0.3428
0.3526	0.3578	0.3440	0.3428	0.3514	0.3487
0.3539	0.3669	0.3448	0.3514	0.3526	0.3578

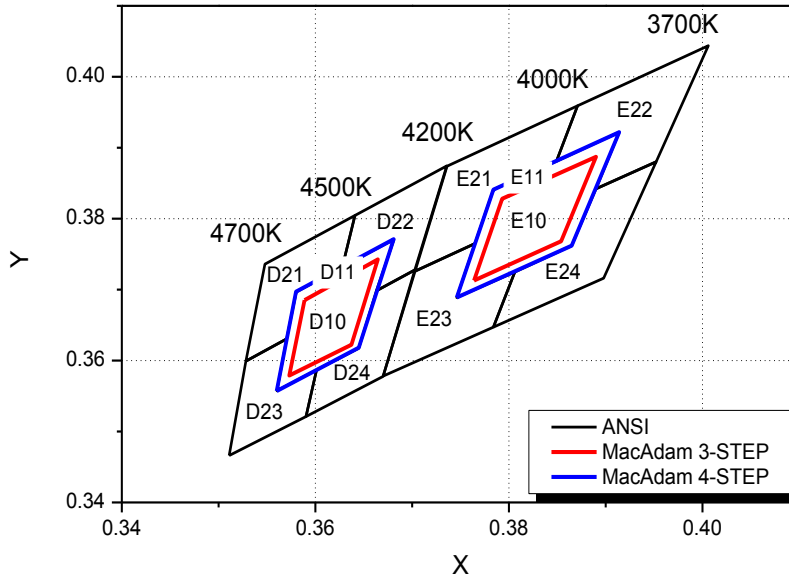

## Color Bin Structure

**CIE Chromaticity Diagram,  $T_j=25^{\circ}\text{C}$ ,  $I_f=1\text{A}$** 

3-STEP				4-STEP			
D10		E10		D11		E11	
CIE x	CIE y	CIE x	CIE y	CIE x	CIE y	CIE x	CIE y
0.3589	0.3685	0.3764	0.3713	0.3560	0.3557	0.3746	0.3689
0.3665	0.3742	0.3793	0.3828	0.3580	0.3697	0.3784	0.3841
0.3637	0.3622	0.3890	0.3887	0.3681	0.3771	0.3914	0.3922
0.3573	0.3579	0.3854	0.3768	0.3645	0.3618	0.3865	0.3762

ANSI							
D21		D22		D23		D24	
CIE x	CIE y	CIE x	CIE y	CIE x	CIE y	CIE x	CIE y
0.3528	0.3599	0.3628	0.3732	0.3601	0.3587	0.3511	0.3466
0.3548	0.3736	0.3641	0.3805	0.3645	0.3618	0.3528	0.3599
0.3641	0.3805	0.3736	0.3874	0.3663	0.3699	0.3570	0.3631
0.3628	0.3732	0.3703	0.3728	0.3703	0.3728	0.3560	0.3558
0.3580	0.3697	0.3663	0.3699	0.3670	0.3578	0.3601	0.3587
0.3570	0.3631	0.3681	0.3771	0.3590	0.3521	0.3590	0.3521
E21		E22		E23		E24	
CIE x	CIE y	CIE x	CIE y	CIE x	CIE y	CIE x	CIE y
0.3703	0.3726	0.3890	0.3842	0.3670	0.3578	0.3784	0.3647
0.3736	0.3874	0.3914	0.3922	0.3703	0.3726	0.3806	0.3725
0.3871	0.3959	0.3849	0.3881	0.3765	0.3765	0.3865	0.3762
0.3849	0.3881	0.3871	0.3959	0.3746	0.3689	0.3890	0.3842
0.3784	0.3841	0.4006	0.4044	0.3806	0.3725	0.3952	0.3880
0.3765	0.3765	0.3952	0.3880	0.3784	0.3647	0.3898	0.3716

## Color Bin Structure

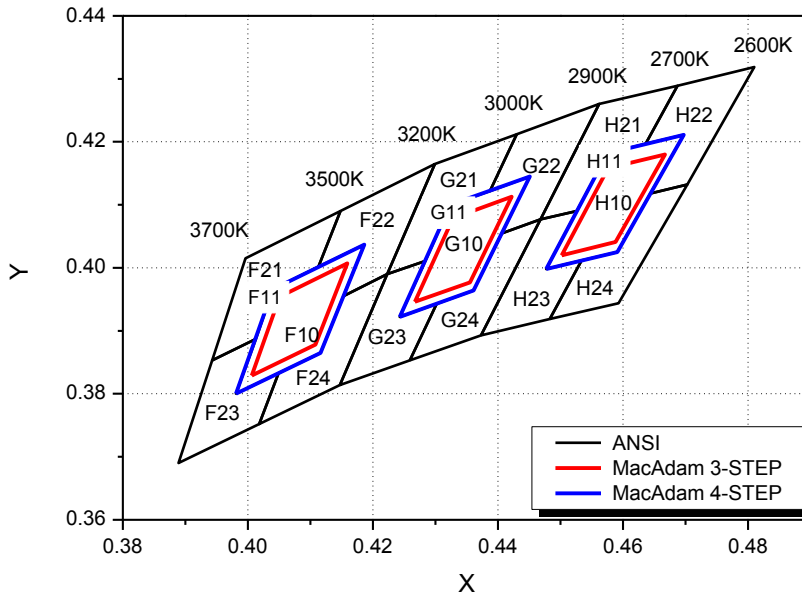
**CIE Chromaticity Diagram,  $T_j=25^{\circ}\text{C}$ ,  $I_f=1\text{A}$** 

3-STEP						4-STEP					
F10		G10		H10		F11		G11		H11	
CIE x	CIE y	CIE x	CIE y	CIE x	CIE y	CIE x	CIE y	CIE x	CIE y	CIE x	CIE y
0.4006	0.3829	0.4267	0.3946	0.4502	0.4020	0.3981	0.3800	0.4243	0.3922	0.4477	0.3998
0.4051	0.3954	0.4328	0.4079	0.4576	0.4158	0.4040	0.3966	0.4324	0.4100	0.4575	0.4182
0.4159	0.4007	0.4422	0.4113	0.4667	0.4180	0.4186	0.4037	0.4451	0.4145	0.4697	0.4211
0.4108	0.3878	0.4355	0.3977	0.4588	0.4041	0.4116	0.3865	0.4361	0.3964	0.4591	0.4025
ANSI											
F21		F22		F23		F24					
CIE x	CIE y	CIE x	CIE y	CIE x	CIE y	CIE x	CIE y				
0.4148	0.4090	0.4013	0.3887	0.4223	0.3990	0.4299	0.4165				
0.3996	0.4015	0.3943	0.3853	0.4153	0.3955	0.4148	0.4090				
0.3943	0.3853	0.3889	0.3690	0.4116	0.3865	0.4113	0.4002				
0.4013	0.3887	0.4018	0.3752	0.4049	0.3833	0.4186	0.4037				
0.4040	0.3966	0.4049	0.3833	0.4018	0.3752	0.4153	0.3955				
0.4113	0.4002	0.3981	0.3800	0.4147	0.3814	0.4223	0.3990				
G21		G22		G23		G24					
CIE x	CIE y	CIE x	CIE y	CIE x	CIE y	CIE x	CIE y				
0.4223	0.3990	0.4406	0.4055	0.4147	0.3814	0.4259	0.3853				
0.4299	0.4165	0.4451	0.4145	0.4223	0.3990	0.4302	0.3943				
0.4430	0.4212	0.4387	0.4122	0.4284	0.4011	0.4361	0.3964				
0.4387	0.4122	0.4430	0.4212	0.4243	0.3922	0.4406	0.4055				
0.4324	0.4100	0.4562	0.4260	0.4302	0.3943	0.4468	0.4077				
0.4284	0.4011	0.4468	0.4077	0.4259	0.3853	0.4373	0.3893				
H21		H22		H23		H24					
CIE x	CIE y	CIE x	CIE y	CIE x	CIE y	CIE x	CIE y				
0.4468	0.4077	0.4644	0.4118	0.4373	0.3893	0.4483	0.3919				
0.4562	0.4260	0.4697	0.4211	0.4468	0.4077	0.4534	0.4012				
0.4687	0.4289	0.4636	0.4197	0.4526	0.4090	0.4591	0.4025				
0.4636	0.4197	0.4687	0.4289	0.4477	0.3998	0.4644	0.4118				
0.4575	0.4182	0.4810	0.4319	0.4534	0.4012	0.4703	0.4132				
0.4526	0.4090	0.4703	0.4132	0.4483	0.3919	0.4593	0.3944				

## Mechanical Dimensions

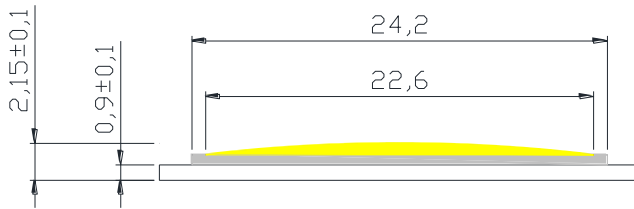
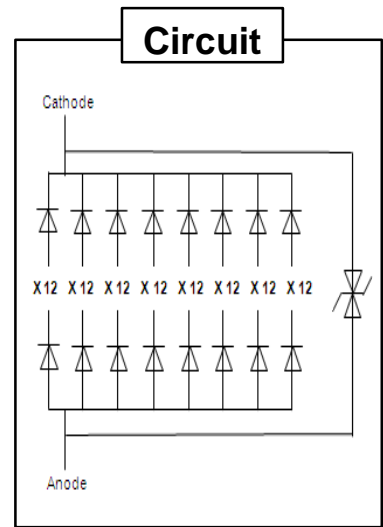
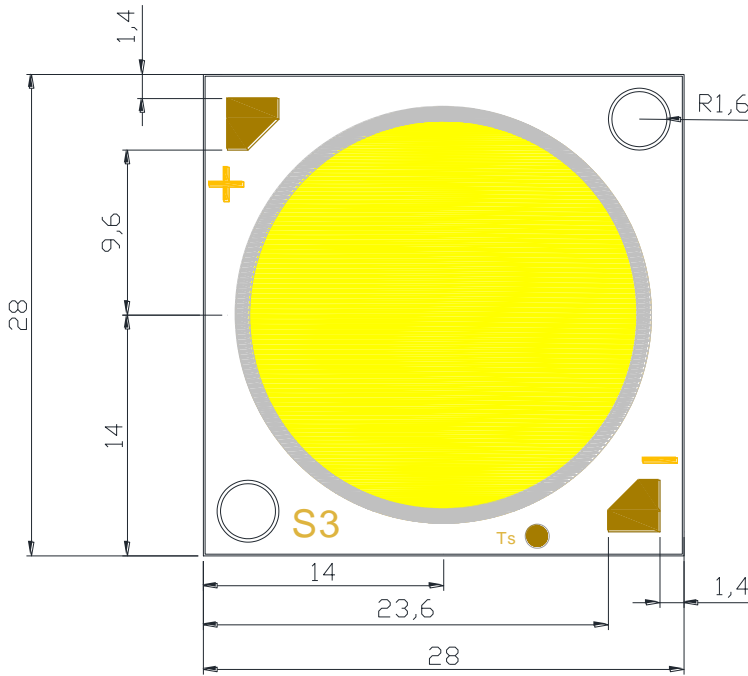

### Notes :

- (1) All dimensions are in millimeters.
- (2) Scale : none
- (3) Undefined tolerance is  $\pm 0.2\text{mm}$

# Packaging Specification

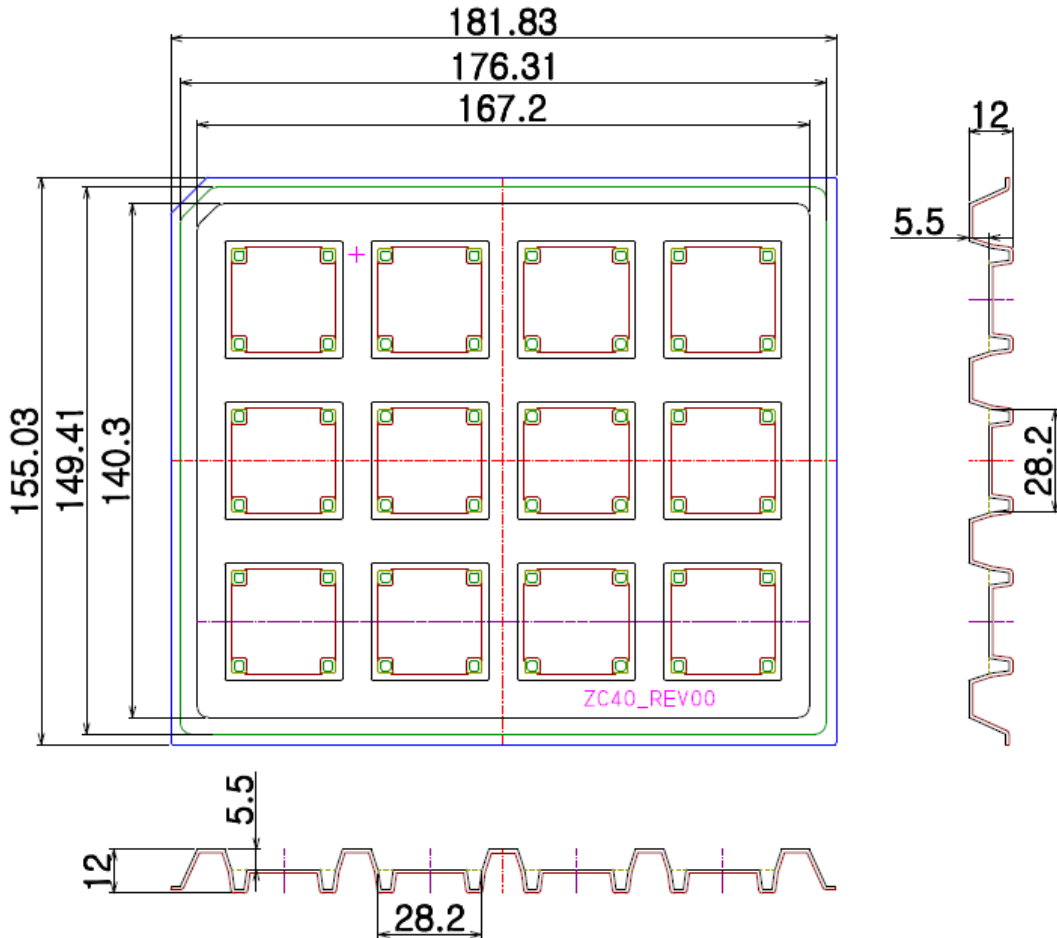

**Notes :**

- (1) Quantity : 12pcs/Tray
- (2) All dimensions are in millimeters (tolerance :  $\pm 0.3$ )
- (3) Scale none

## Packaging Specification

### Aluminum Bag

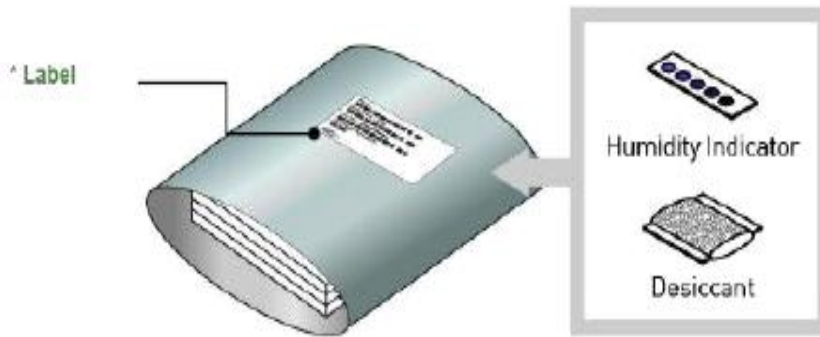

### Outer Box

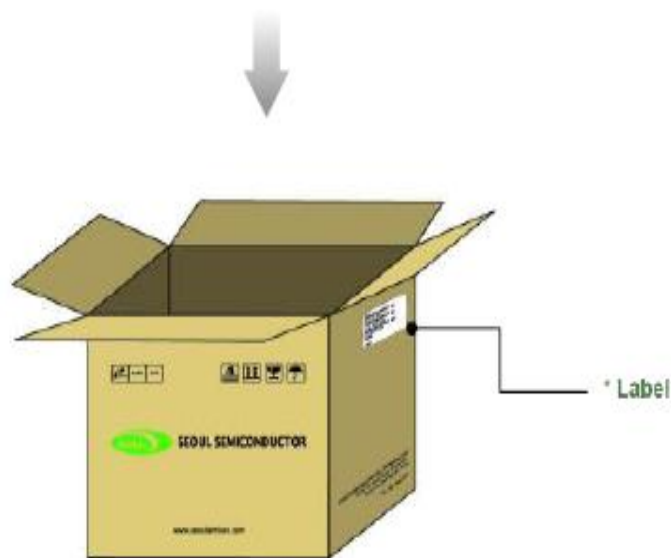

#### Notes :

- (1) Heat Sealed after packing (Use Zipper Bag)
- (2) Quantity : 3Tray(36pcs) /Bag

## Product Nomenclature

**Table 5. Part Numbering System : X<sub>1</sub>X<sub>2</sub>X<sub>3</sub> X<sub>4</sub>X<sub>5</sub> X<sub>6</sub>X<sub>7</sub> X<sub>8</sub>**

Part Number Code	Description	Part Number	Value
X <sub>1</sub>	Company	S	
X <sub>2</sub>	Package series	D	
X <sub>3</sub> X <sub>4</sub>	Color Specification	W0	CRI 70
		W8	CRI 80
		W9	CRI 90
X <sub>5</sub>	Series number	5	
X <sub>6</sub>	Lens type	F	Flat
X <sub>7</sub>	PCB type	1	PCB
X <sub>8</sub>	Revision number	C	New COB type

**Table 6. Lot Numbering System : Y<sub>1</sub>Y<sub>2</sub>Y<sub>3</sub>Y<sub>4</sub>Y<sub>5</sub>Y<sub>6</sub> Y<sub>7</sub>Y<sub>8</sub>Y<sub>9</sub>Y<sub>10</sub> – Y<sub>11</sub>Y<sub>12</sub>Y<sub>13</sub>Y<sub>14</sub>Y<sub>15</sub>Y<sub>16</sub>Y<sub>17</sub>**

Lot Number Code	Description
Y <sub>1</sub> Y <sub>2</sub> Y <sub>3</sub> Y <sub>4</sub> Y <sub>5</sub>	Date of box packing
Y <sub>6</sub> Y <sub>7</sub> Y <sub>8</sub> Y <sub>9</sub> Y <sub>10</sub>	Date of label order
Y <sub>11</sub> Y <sub>12</sub> Y <sub>13</sub> Y <sub>14</sub> Y <sub>15</sub> Y <sub>16</sub> Y <sub>17</sub>	Item code

## Handling of Silicone Resin for LEDs

- (1) During processing, mechanical stress on the surface should be minimized as much as possible. Sharp objects of all types should not be used to pierce the sealing compound.



- (2) In general, LEDs should only be handled from the side. By the way, this also applies to LEDs without a silicone sealant, since the surface can also become scratched.

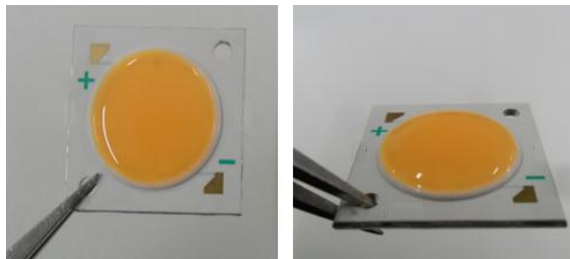

- (3) Silicone differs from materials conventionally used for the manufacturing of LEDs. These conditions must be considered during the handling of such devices. Compared to standard encapsulants, silicone is generally softer, and the surface is more likely to attract dust. As mentioned previously, the increased sensitivity to dust requires special care during processing. In cases where a minimal level of dirt and dust particles cannot be guaranteed, a suitable cleaning solution must be applied to the surface after the soldering of wire.
- (4) Seoul Semiconductor suggests using isopropyl alcohol for cleaning. In case other solvents are used, it must be assured that these solvents do not dissolve the package or resin. Ultrasonic cleaning is not recommended. Ultrasonic cleaning may cause damage to the LED.
- (5) Please do not mold this product into another resin (epoxy, urethane, etc) and do not handle this product with acid or sulfur material in sealed space.
- (6) Avoid leaving fingerprints on silicone resin parts.

## Precaution for Use

(1) Storage

To avoid the moisture penetration, we recommend storing Power LEDs in a dry box with a desiccant.

(2) For manual soldering

Seoul Semiconductor recommends the soldering condition

(ZC series product is not adaptable to reflow process)

a. Use lead-free soldering

b. Soldering should be implemented using a soldering equipment at temperature lower than 350°C.

c. Before proceeding the next step, product temperature must be stabilized at room temperature.

(3) Components should not be mounted on warped (non coplanar) portion of PCB.

(4) Radioactive exposure is not considered for the products listed here in.

(5) It is dangerous to drink the liquid or inhale the gas generated by such products when chemically disposed of.

(6) This device should not be used in any type of fluid such as water, oil, organic solvent and etc. When washing is required, IPA (Isopropyl Alcohol) should be used.

(7) When the LEDs are in operation the maximum current should be decided after measuring the package temperature.

(8) The appearance and specifications of the product may be modified for improvement without notice.

(9) Long time exposure of sun light or occasional UV exposure will cause silicone discoloration.

(10) Attaching LEDs, do not use adhesive that outgas organic vapor.

(11) The driving circuit must be designed to allow forward voltage only when it is ON or OFF. If the reverse voltage is applied to LED, migration can be generated resulting in LED damage.

(12) Please do not touch any of the circuit board, components or terminals with bare hands or metal while circuit is electrically active.



## Precaution for Use

(13) VOCs (Volatile organic compounds) emitted from materials used in the construction of fixtures can penetrate silicone encapsulants of LEDs and discolor when exposed to heat and photonic energy. The result can be a significant loss of light output from the fixture. Knowledge of the properties of the materials selected to be used in the construction of fixtures can help prevent these issues.

(14) LEDs are sensitive to Electro-Static Discharge (ESD) and Electrical Over Stress (EOS). Below is a list of suggestions that Seoul Semiconductor purposes to minimize these effects.

### I . ESD (Electro Static Discharge)

Electrostatic discharge (ESD) is defined as the release of static electricity when two objects come into contact. While most ESD events are considered harmless, it can be an expensive problem in many industrial environments during production and storage. The damage from ESD to LEDs may cause the product to demonstrate unusual characteristics such as:

- Increase in reverse leakage current lowered turn-on voltage
- Abnormal emissions from the LED at low current

The following recommendations are suggested to help minimize the potential for an ESD event. One or more recommended work area suggestions:

- Ionizing fan setup
- ESD table/shelf mat made of conductive materials
- ESD safe storage containers

One or more personnel suggestion options:

- Antistatic wrist-strap
- Antistatic material shoes
- Antistatic clothes

Environmental controls:

- Humidity control (ESD gets worse in a dry environment)

## Precaution for Use

### II. EOS (Electrical Over Stress)

Electrical Over-Stress (EOS) is defined as damage that may occur when an electronic device is subjected to a current or voltage that is beyond the maximum specification limits of the device. The effects from an EOS event can be noticed through product performance like:

- Changes to the performance of the LED package  
(If the damage is around the bond pad area and since the package is completely encapsulated the package may turn on but flicker show severe performance degradation.)
- Changes to the light output of the luminaire from component failure
- Components on the board not operating at determined drive power

Failure of performance from entire fixture due to changes in circuit voltage and current across total circuit causing trickle down failures. It is impossible to predict the failure mode of every LED exposed to electrical overstress as the failure modes have been investigated to vary, but there are some common signs that will indicate an EOS event has occurred:

- Damaged may be noticed to the bond wires (appearing similar to a blown fuse)
- Damage to the bond pads located on the emission surface of the LED package  
(shadowing can be noticed around the bond pads while viewing through a microscope)
- Anomalies noticed in the encapsulation and phosphor around the bond wires.
- This damage usually appears due to the thermal stress produced during the EOS event.

III. To help minimize the damage from an EOS event Seoul Semiconductor recommends utilizing:

- A surge protection circuit
- An appropriately rated over voltage protection device
- A current limiting device



## Company Information

### Published by

Seoul Semiconductor © 2013 All Rights Reserved.

### Company Information

Seoul Semiconductor ([www.SeoulSemicon.com](http://www.SeoulSemicon.com)) manufactures and packages a wide selection of light emitting diodes (LEDs) for the automotive, general illumination/lighting, Home appliance, signage and back lighting markets. The company is the world's fifth largest LED supplier, holding more than 10,000 patents globally, while offering a wide range of LED technology and production capacity in areas such as "nPola", "Acrich", the world's first commercially produced AC LED, and "Acrich MJT - Multi-Junction Technology" a proprietary family of high-voltage LEDs.

The company's broad product portfolio includes a wide array of package and device choices such as Acrich and Acirch2, high-brightness LEDs, mid-power LEDs, side-view LEDs, and through-hole type LEDs as well as custom modules, displays, and sensors.

### Legal Disclaimer

Information in this document is provided in connection with Seoul Semiconductor products. With respect to any examples or hints given herein, any typical values stated herein and/or any information regarding the application of the device, Seoul Semiconductor hereby disclaims any and all warranties and liabilities of any kind, including without limitation, warranties of non-infringement of intellectual property rights of any third party. The appearance and specifications of the product can be changed to improve the quality and/or performance without notice.