

# Antenna

# YF0006AA Datasheet

## Antenna Services

Version: 1.2

Date: 2020-12-11

Status: Released



**Our aim is to provide customers with timely and comprehensive service. For any assistance, please contact our company headquarters:**

**Quectel Wireless Solutions Co., Ltd.**

Building 5, Shanghai Business Park Phase III (Area B), No.1016 Tianlin Road, Minhang District, Shanghai 200233, China

Tel: +86 21 5108 6236

Email: [info@quectel.com](mailto:info@quectel.com)

**Or our local office. For more information, please visit:**

<http://www.quectel.com/support/sales.htm>.

**For technical support, or to report documentation errors, please visit:**

<http://www.quectel.com/support/technical.htm>

Or email to [support@quectel.com](mailto:support@quectel.com).

## **General Notes**

Quectel offers the information as a service to its customers. The information provided is based upon customers' requirements. Quectel makes every effort to ensure the quality of the information it makes available. Quectel does not make any warranty as to the information contained herein, and does not accept any liability for any injury, loss or damage of any kind incurred by use of or reliance upon the information. All information supplied herein is subject to change without prior notice.

## **Disclaimer**

While Quectel has made efforts to ensure that the functions and features under development are free from errors, it is possible that these functions and features could contain errors, inaccuracies and omissions. Unless otherwise provided by valid agreement, Quectel makes no warranties of any kind, implied or express, with respect to the use of features and functions under development. To the maximum extent permitted by law, Quectel excludes all liability for any loss or damage suffered in connection with the use of the functions and features under development, regardless of whether such loss or damage may have been foreseeable.

## **Duty of Confidentiality**

The Receiving Party shall keep confidential all documentation and information provided by Quectel, except when the specific permission has been granted by Quectel. The Receiving Party shall not access or use Quectel's documentation and information for any purpose except as expressly provided herein. Furthermore, the Receiving Party shall not disclose any of the Quectel's documentation and information to any third party without the prior written consent by Quectel. For any noncompliance to the above requirements, unauthorized use, or other illegal or malicious use of the documentation and information, Quectel will reserve the right to take legal action.

## Copyright

The information contained here is proprietary technical information of Quectel. Transmitting, reproducing, disseminating and editing this document as well as using the content without permission are forbidden. Offenders will be held liable for payment of damages. All rights are reserved in the event of a patent grant or registration of a utility model or design.

***Copyright © Quectel Wireless Solutions Co., Ltd. 2020. All rights reserved.***

# About the Document

## Revision History

Version	Date	Author	Note
1.0	2020-06-08	Kenny YIN	Initial
1.1	2020-11-19	Kenny YIN	Updated the antenna picture with the new silkscreen in Chapter 1.
1.2	2020-12-11	Kenny YIN	Updated the antenna picture in Chapter 2.

## Contents

About the Document .....	3
Contents .....	4
1 Product Description.....	5
2 Product Features .....	5
3 Product Specifications .....	6
4 Overall Performance.....	7
5 Product Size .....	14

## 1 Product Description

The antenna is designed for superior performance, and can be widely used for wireless applications.

We provide comprehensive antenna design support such as simulation, testing and manufacturing for custom antenna solutions to meet your specific application needs.

## 2 Product Features

- LTE Full-Band FPC Antenna
- High efficiency
- Excellent performance



### 3 Product Specifications

#### Passive Electrical Specifications

Frequency Range	690–960 MHz, 1710–2170 MHz, 2300–2690 MHz
Input Impedence	50 $\Omega$
VSWR	$\leq 3.0$
Gain	$\leq 6$ dBi
Polarization Type	Linear

#### Mechanical Specifications

Antenna Size	50 mm x 25 mm x 0.13 mm
Casing	FPC
Connector Type	U.FL
Working Temperature	-20 °C to +80 °C
Radome Color	Black

## 4 Overall Performance

- Test Environment
  - KEYSIGHT VNA Network Analyzer E5063A 100 kHz – 6.5 GHz.
  - RayZone® 2800 Chamber 5G (FR1) SISO/MIMO, 400 MHz – 6.0 GHz.





● VSWR

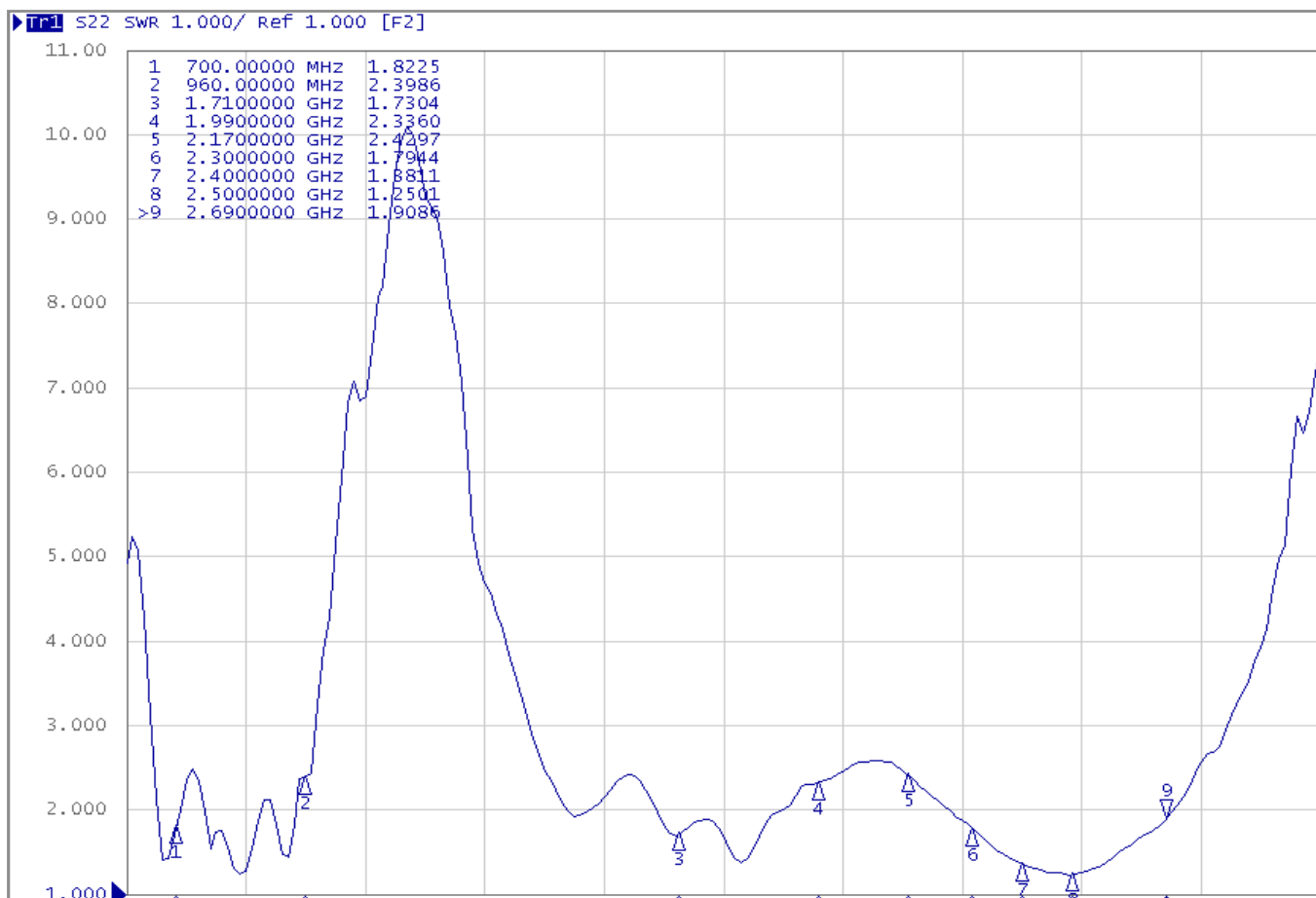

Frequency(MHz)	700	960	1710	1990	2170	2300	2400	2500	2690
VSWR	1.82	2.40	1.73	2.34	2.43	1.79	1.88	1.25	1.91

- Efficiency

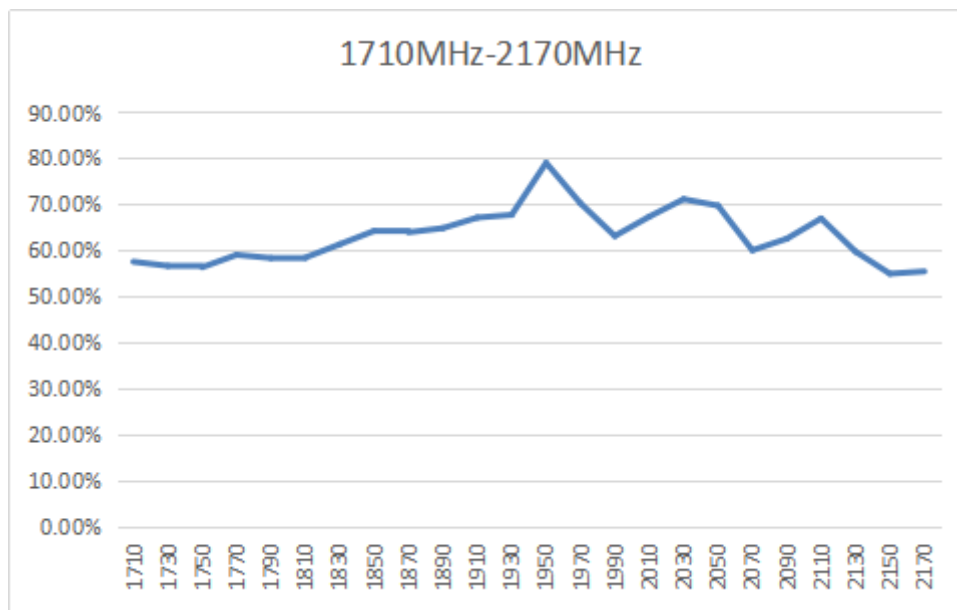
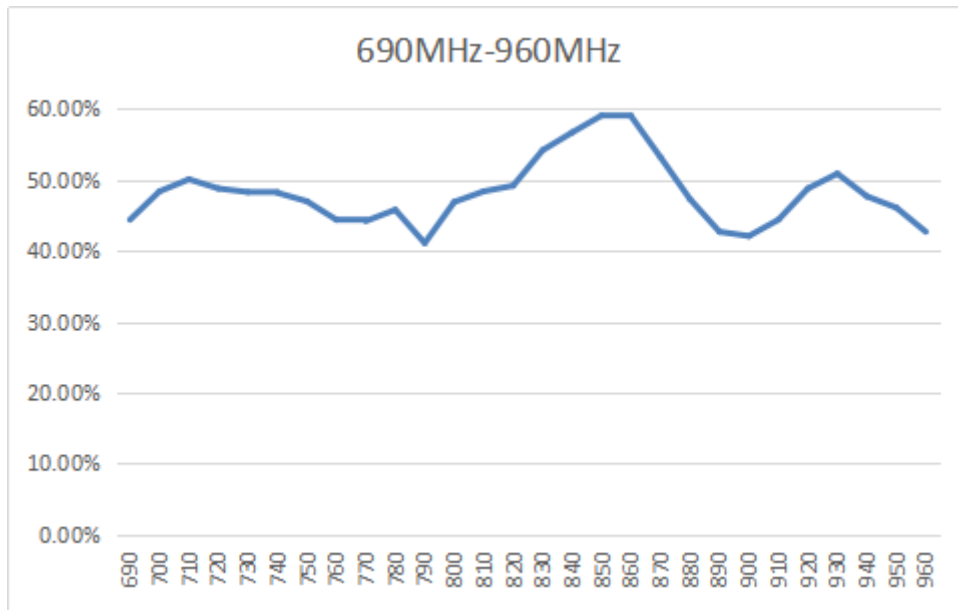

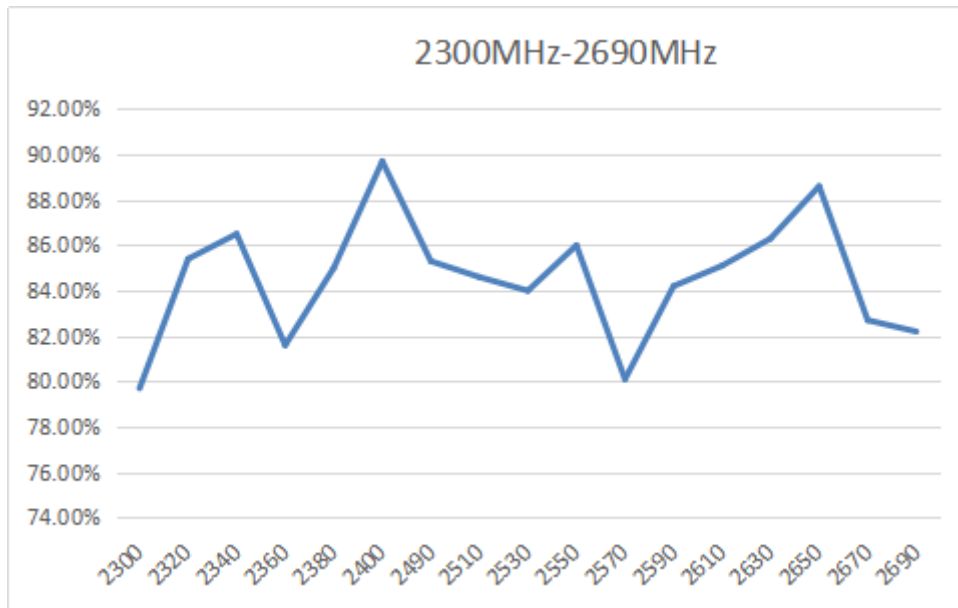

<b>Frequency(MHz)</b>	690	820	960	1710	1990	2170	2300	2590	2690
<b>Efficiency(%)</b>	44.4	49.2	42.7	57.5	63.1	55.4	79.7	84.2	82.2

- Gain

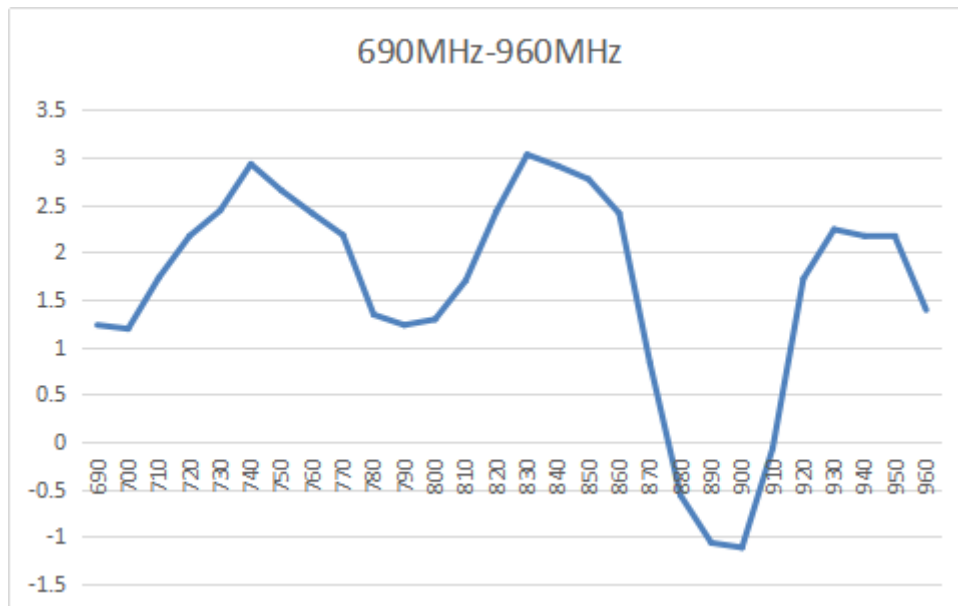

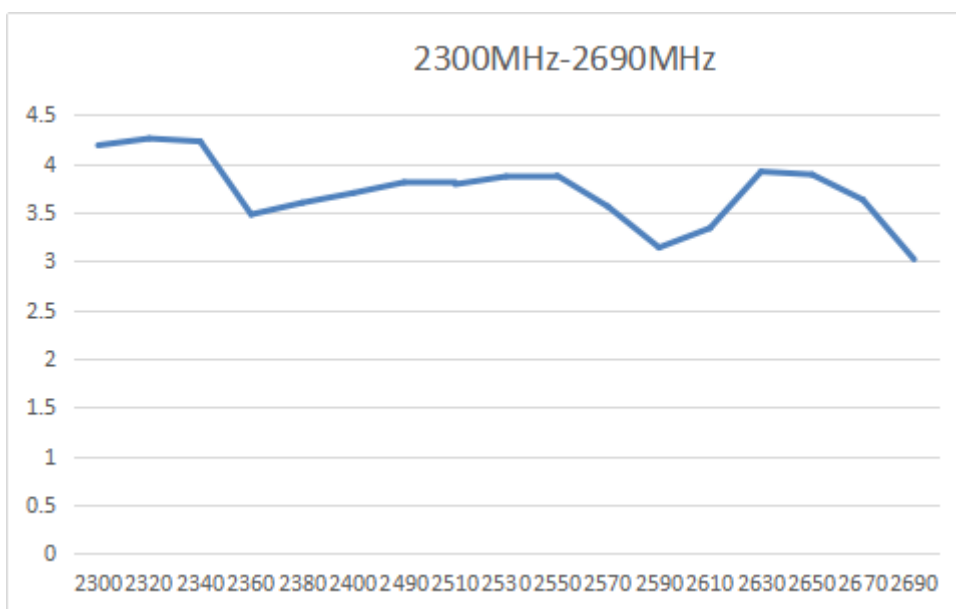
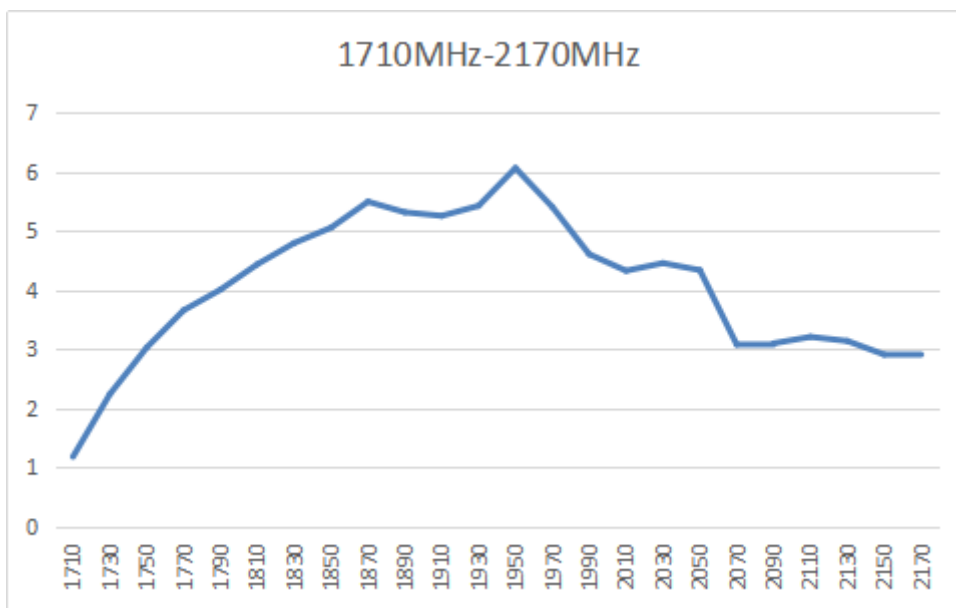

Frequency(MHz)	690	820	960	1710	1990	2170	2300	2590	2690
Gain(dBi)	1.23	2.43	1.89	2.18	4.61	2.93	4.19	3.14	3.02

● Radiation Patterns

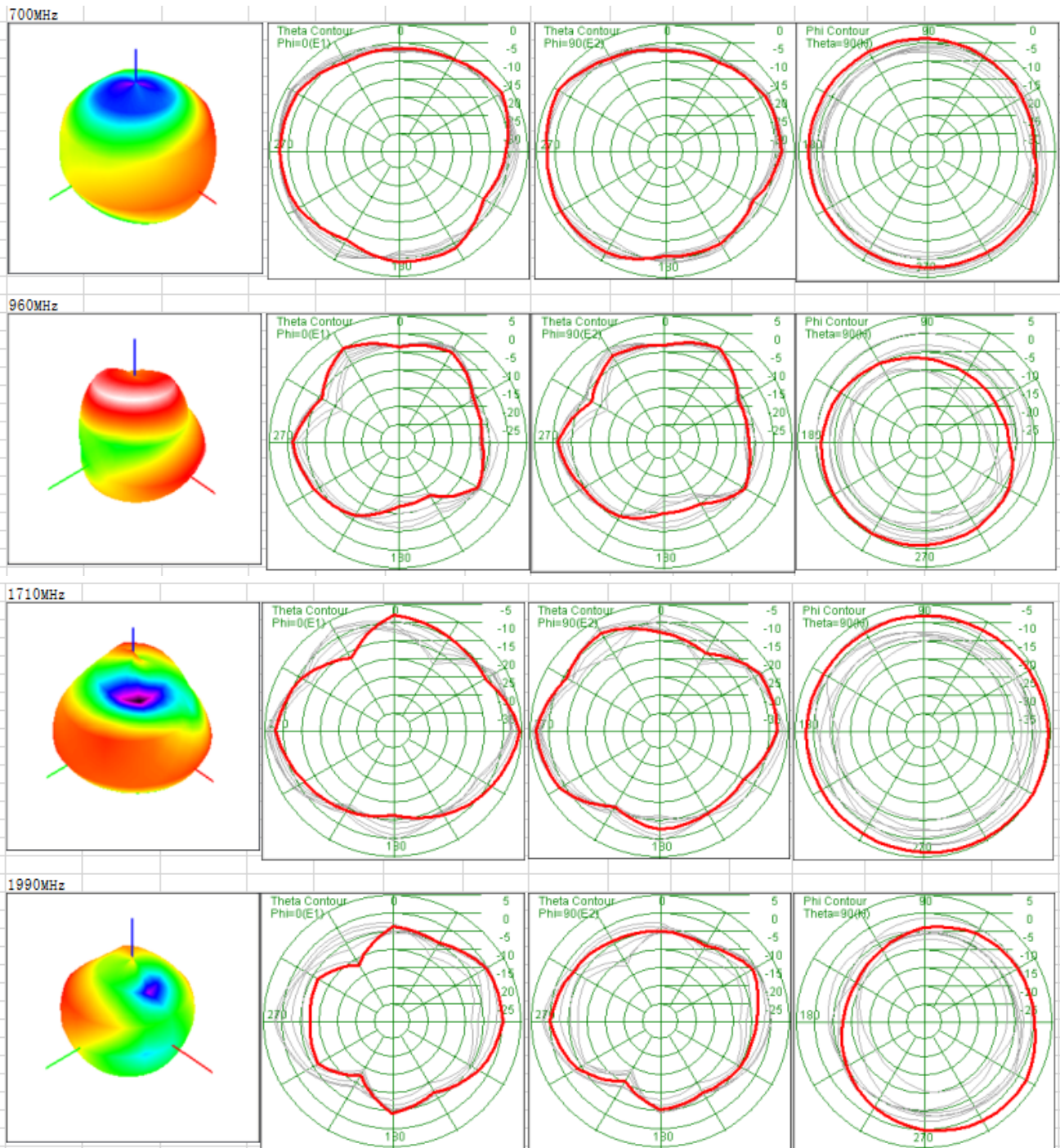

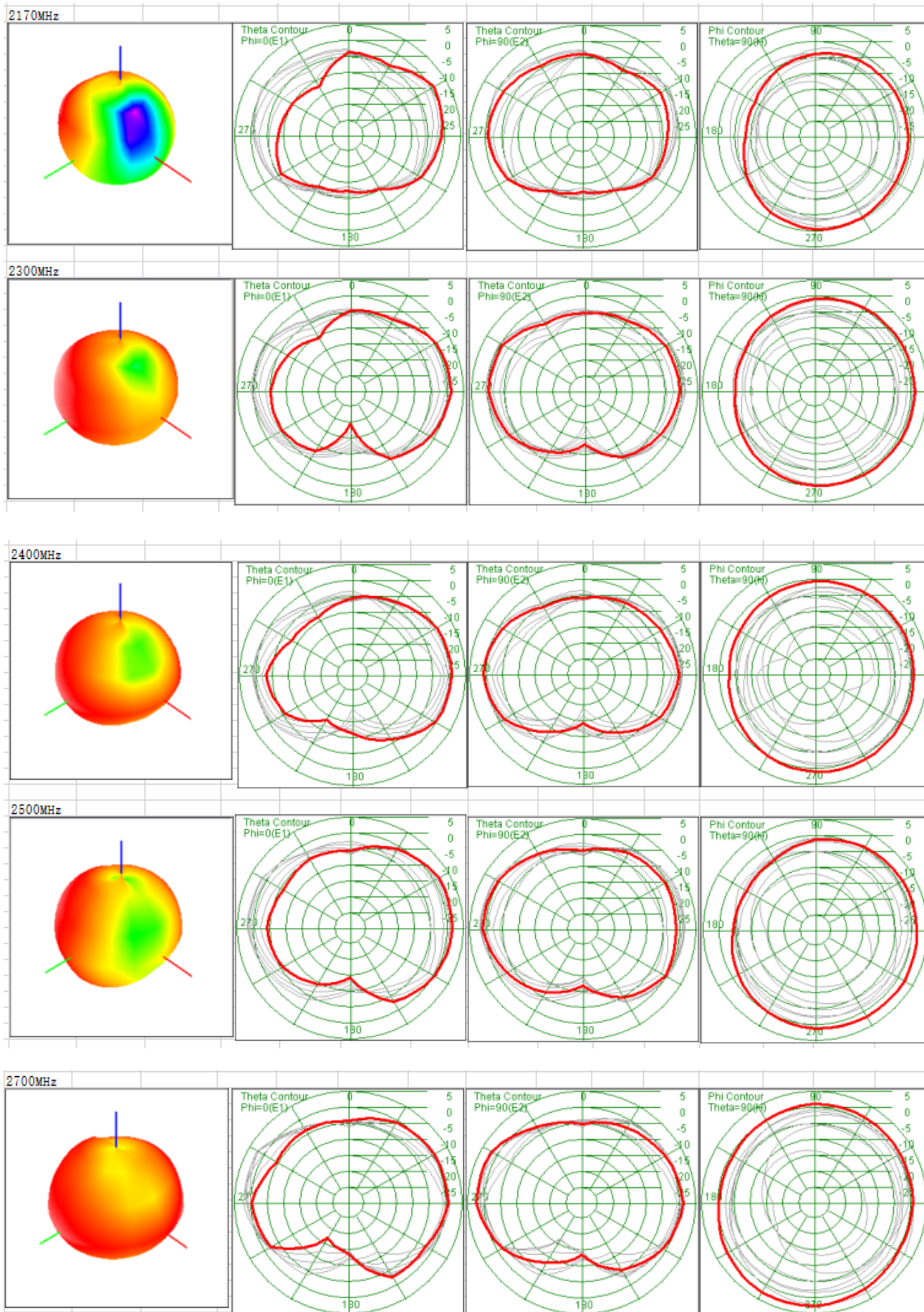

## 5 Product Size

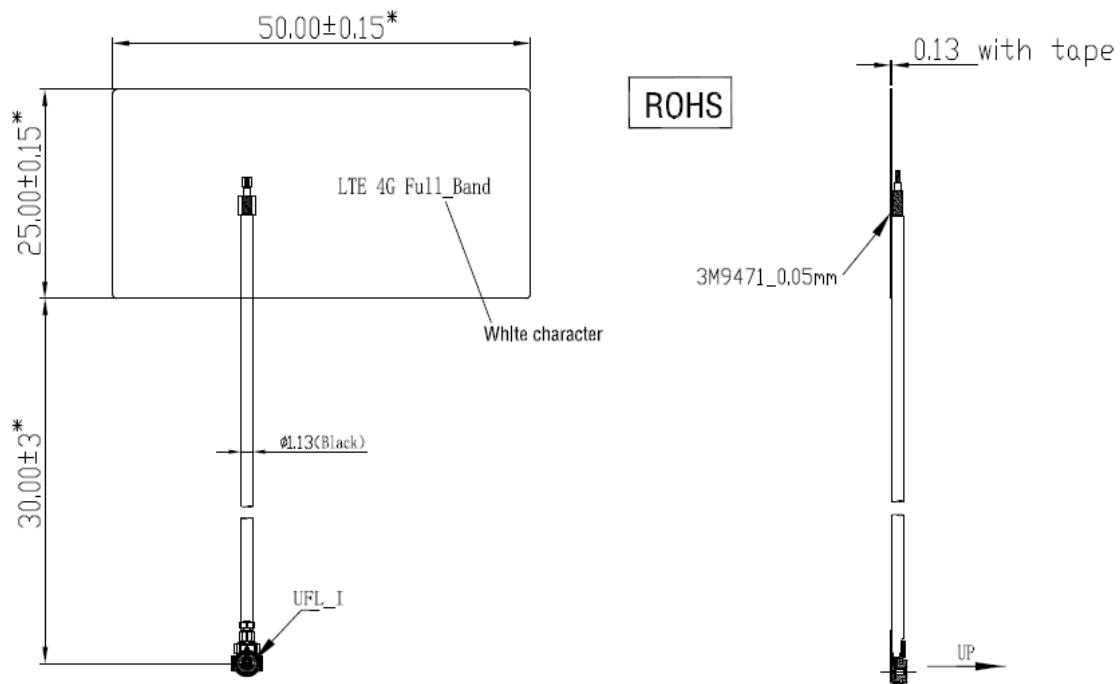

# Mouser Electronics

Authorized Distributor

Click to View Pricing, Inventory, Delivery & Lifecycle Information:

[Quectel:](#)

[YF0006AA](#)