

2PM系列
2PM Series connectors



产品简介 Products introduction

2PM系列俄式军用连接器，主要是采用了俄罗斯军用连接器的技术，其广泛用于军用设备之间的电连接和信号传输，其独有的外形及结构设计能弥补很多其他类似连接器在用途上的缺陷，例如外壳穿线孔及尾部螺丝的独特设计，使其运用当中更加便利科学。内部绝缘体及插针插孔的结构设计也增强了其独有的稳定及可靠性，此系列连接器同时也具体一定的防水性能，可以防止室外雨淋等现象，现主要有2PM14-4，2PM18-4，2PM18-7等规格，其特殊的结构和使用性能已经赢得了市场的普遍认可。

2PM russian type ministry connector, which is made according to the Russian Ministry Standard, widely used for the electricity connection and signal transfer, it's special structure and design can avoid the shortage of other similar connectors, for example, the screw&hole for the wire on the outer shell, it can be used more conveniently. The inner insulation and pins structure are also enhanced its stability and reliability, this series of connectors can also be waterproof, so it can be used on outdoor equipments, presently it has such specifications, 2PM14-4, 2PM18-4, 2PM18-7... Its special design and characteristics have got good reputation from the market.





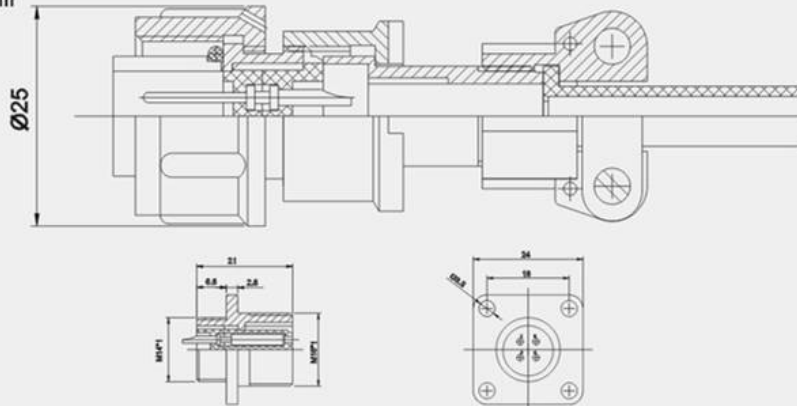

技术性能 Technical characteristics

工作温度	-60℃~+150℃	Temperature	-60℃~+150℃
额定电压	400V (AC)	Voltage	400V (AC)
额定电流	φ 1.0-5A φ 1.5-10A	Current	φ 1.0-5A φ 1.5-10A
接触电阻	φ 1.0-0.005 Ω φ 1.5-0.0025 Ω	Contact Resistance	φ 1.0-0.005 Ω φ 1.5-0.0025 Ω
绝缘电阻	正常条件 不小于20M Ω 湿热条件 不小于2M Ω	Insulation Resistance	Normal ≤20M Ω High ≤M Ω
壳体电阻	不大于0.002 Ω	Ring Resistance	≥0.002 Ω
振动	10~200Hz 10g	Collide	10~200Hz 10g
冲击	40~100次/分钟 7g	Vibration	40~100strokes/S 7g
恒加速度	25g	Constant Acceleration	25g
试验电压	1500V 1分钟	Test Voltage	1500V 1S

外形示意图 Dimensions

单位: mm



排列组合号 壳体号	14/4/1		接触体尺寸 图样			
14			φ1	φ1.5	φ2	φ3
18	18/7/1	18/4/5	22	22/4/3		22/10/1
						
24	24/10/5		24/19/1			
						

型号命名方法 Ordering information

